

# Brainsight<sup>®</sup>

## Vet Robot

USER MANUAL

v2.5.8

(March 2025)

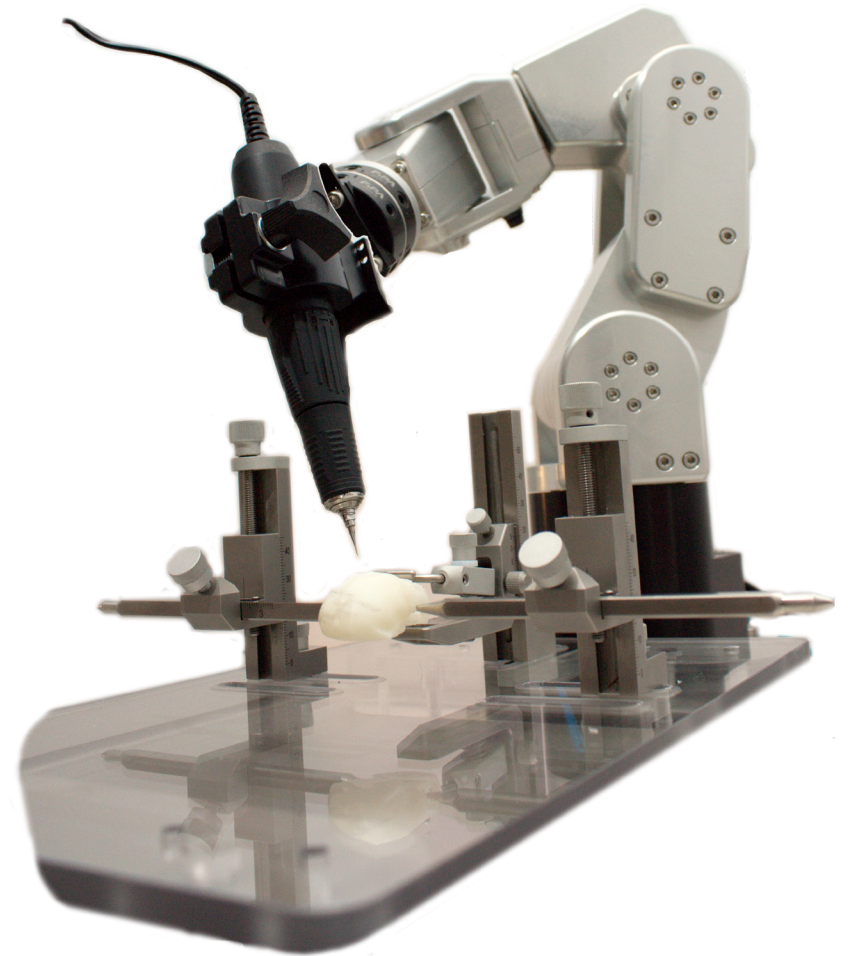
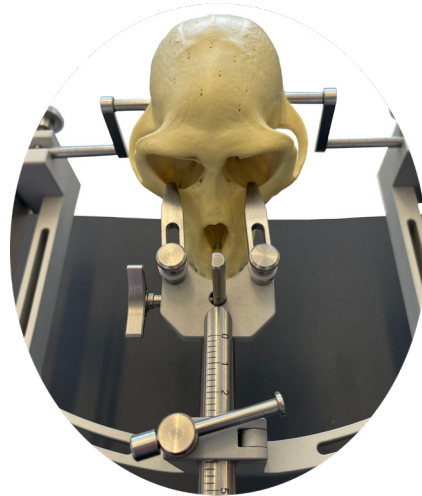



**Rogue Research Inc.**

**Rogue Research Inc.**  
6666 Boul. St. Urbain, #300  
Montreal, QC  
H2S 3H1

+1 (514) 284-3888  
866-984-3888 Toll Free (North America)  
(514) 284-6750 Fax  
[info@rogue-research.com](mailto:info@rogue-research.com)

**Note:**

**The Brainsight software includes the latest user manual pertinent to that software version. You can access it electronically within the Brainsight application by selecting "View User Manual" from the help menu. This will launch a document viewer where you can view or print the manual.**

Your Serial Number is:
Your Computer Password is:

# Index

# Brainsight® Vet

USER MANUAL  
v2.5



<b>END-USER LICENSE AGREEMENT</b>	<b>V</b>	<b>HOW TO GET HELP (or HOW YOU CAN HELP US MAKE BRAINSIGHT BETTER FOR YOU)</b>	<b>2</b>
1. License	v	Chapter 2: Overview of Robot-assisted Surgery	3
2. Permitted Uses and Restrictions	v	<b>INTRODUCTION</b>	<b>3</b>
3. Copyright	vi	<b>NEURONAVIGATION PRIMER</b>	<b>3</b>
4. Transfer	vi	<b>TYPICAL STEPS FOR IMAGE-GUIDED SURGERY</b>	<b>4</b>
Trademarks	vi	Calibrate the cameras	4
<b>COMPONENT LICENSE AGREEMENTS</b>	<b>VI</b>	Calibrate your tracked surgical tool	5
VTK	vi	Scan the subject	5
ITK	vii	Select the anatomical data set	6
GDCM	vii	Co-register to the MNI coordinate space or other anatomical dataset	6
OpenCV	vii	Select one or more overlay data sets	7
AMSerialPort	vii	Create a Region of Interest using the Region Paint Tool	7
Remote Control Wrapper	viii	Perform 3D reconstruction(s)	7
FeedbackReporter	viii	Select landmarks for registration	8
libusb	viii	Select your target(s)	8
Labjack exodriver	xii	Perform surgery	8
MNI 152 Average Brain (used in MNI-based projects)	xiii	Review the acquired data	9
Warnings and Cautions	xiv	Atlas references	9
Change Log	xiv	Chapter 3: Setting Up the Brainsight Robot	11
Chapter 1: Introduction	1	<b>SYSTEM OVERVIEW</b>	<b>11</b>
<b>HOW THIS DOCUMENT IS ORGANIZED</b>	<b>1</b>		
Document formatting	1		
<b>THIS USED TO BE CALLED BRAINSIGHT 2?</b>	<b>1</b>		
<b>SYSTEM REQUIREMENTS</b>	<b>2</b>		

Brainsight navigation computer	11	29	View selector	41
Robot controller module	11	Identify the tip and shafts in the camera view	Inspector	41
Aluminum base plate	11	DOs and DON'Ts with this method	Full screen control	42
Robot	11	<b>SOME ADDITIONAL ROBOT TOOLS</b>	Cursor tool	42
Stereo-imaging cameras	12	Chamber positioning tool	Ruler tool	42
Stereotaxic frame for head fixation	12	Needle holder and catheter or electrode holder	3D Crop box	42
<b>ASSEMBLING THE ROBOT</b>	<b>13</b>			
<b>SETTING UP THE STEREOTAXIC APPARATUS</b>	<b>14</b>	Chapter 5: Scanning Your Subject	Chapter 7: Atlas Registration	45
<b>SETTING UP THE NAVIGATION COMPUTER</b>	<b>15</b>	<b>IMAGE TYPES</b>	<b>MANUAL MNI REGISTRATION</b>	<b>45</b>
Installing the software	15	<b>IMAGING CONSIDERATIONS</b>	<b>LOADING A PRE-EXISTING MATRIX</b>	<b>46</b>
QuickLook Plugin	16	<b>PLACING THE ANIMAL IN THE SCANNER</b>	Chapter 8: Image Overlays	49
Firmware updates	16	Placing the animal in the sphinx position	<b>ADDING FUNCTIONAL OR ANATOMICAL OVERLAYS</b>	<b>49</b>
<b>CALIBRATING THE CAMERAS</b>	<b>19</b>	Placing the animal in the supine position	<b>LOADING MNI MONKEY LABELS ATLAS AND PAXINOS LABELS FOR OVERLAY</b>	<b>51</b>
Setting your preferences	21	<b>IMAGING THE ANIMAL</b>	Chapter 9: Region of Interest (ROI) Painting	53
<b>TESTING THE ROBOT</b>	<b>24</b>	<b>ANIMAL AND IMAGE ORIENTATION</b>	<b>INTRODUCTION</b>	<b>53</b>
Moving the robot	24	<b>NOMENCLATURE</b>	<b>CREATING AN ROI</b>	<b>54</b>
<b>IMPORTANT</b>	<b>25</b>	Chapter 6: Loading Anatomical Images	<b>SEGMENTING THE BRAIN AND SKULL</b>	<b>56</b>
Chapter 4: Calibrating Robot Tools	27	<b>LOADING ANATOMICAL IMAGES</b>	<b>A note on image quality</b>	<b>57</b>
<b>MANAGING TOOL CALIBRATIONS</b>	<b>27</b>	<b>VERIFYING AND CORRECTING IMAGE ORIENTATION</b>	<b>Segmenting the brain</b>	<b>57</b>
<b>SETTING UP A TOOL FOR THE ROBOT</b>	<b>28</b>	<b>THE IMAGE DISPLAY WINDOW</b>	<b>Segmenting the skull</b>	<b>60</b>
<b>ATTACHING A TOOL TO YOUR ROBOT</b>	<b>28</b>	Layout control	Chapter 10: 3D Reconstruction	63
<b>PERFORMING THE CALIBRATION</b>	<b>29</b>	View configuration (HUD)		
Move the robot to make the tool visible in the cameras				

PERFORMING A SKIN RECONSTRUCTION	64	USING CHAMBERS AND GRIDS	78	EXAMINING THE DATA AND CHANGING ATTRIBUTES	99
CREATING A 3D RECONSTRUCTION FROM AN ROI (E.G. BRAIN AND SKULL)	64	Defining grids	79	CONVERTING A SAMPLE TO A TARGET	99
Special notes for skull reconstructions	64	Defining a chamber target	79	EXPORTING THE DATA	99
CREATING A CURVILINEAR RECONSTRUCTION OF THE FULL BRAIN	66	Reviewing potential tracks	80	Exported Data Format	100
IF THE FULL BRAIN CURVILINEAR RECONSTRUCTION DOES NOT WORK	66	Defining special targets	82	Attribute description	100
CREATING A CURVILINEAR SURFACE FROM AN ROI (FOR SMALLER STRUCTURES, OR MANUALLY PAINTED BRAINS)	67	Chapter 13: Performing the Robot Surgery	85	OPTIONAL TROLLEYS FOR THE VET ROBOT SYSTEM	103
CREATING A 3D SURFACE FROM AN OVERLAY BY THRESHOLD	68	INTRODUCTION	85		
IMPORTING 3D SURFACES FROM OTHER SOFTWARE	69	PREPARING THE ROBOT AND SURGICAL INSTRUMENTS	85		
EXPORTING 3D SURFACES	69	Parts required	86		
Chapter 11: Selecting Registration Landmarks for Vet Robot	71	Surgery preparation-computer setup	86		
INTRODUCTION	71	Surgery preparation-position subject and expose skull	86		
MANUAL REGISTRATION	73	Begin the surgery in Brainsight	86		
Chapter 12: Selecting Targets for Surgery	75	Connect to the robot	87		
ANATOMICAL TARGETS (VISUALLY IDENTIFIED)	77	Registration	88		
COORDINATE BASED TARGET	78	Alternate registration	91		
FMRI BASED TARGET	78	Drilling the entry hole	92		
		Perform the injection	95		
		Constant motion	96		
		Chapter 14: Reviewing Study Data	97		
		DISPLAYING THE DATA	97		



# Brainsight<sup>®</sup>

## Vet

USER MANUAL  
v2.5

### END-USER LICENSE AGREEMENT

PLEASE READ THIS SOFTWARE LICENSE AGREEMENT "LICENSE" CAREFULLY BEFORE USING THE SOFTWARE. BY USING THE SOFTWARE, YOU ARE AGREEING TO BE BOUND BY THE TERMS OF THIS LICENSE. IF YOU DO NOT AGREE TO THE TERMS OF THIS LICENSE, PROMPTLY RETURN THE SOFTWARE TO ROGUE RESEARCH INC.

ROGUE RESEARCH AND ITS SUPPLIERS DO NOT AND CANNOT WARRANT THE PERFORMANCE OR RESULTS YOU MAY OBTAIN BY USING THE SOFTWARE OR DOCUMENTATION. ROGUE AND ITS SUPPLIERS MAKE NO WARRANTIES, EXPRESSED OR IMPLIED, AS TO NON-INFRINGEMENT OF THIRD PARTY RIGHTS, MERCHANTABILITY, OR FITNESS FOR ANY PARTICULAR PURPOSE. ANY LIABILITY DUE TO FAILURE OF BRAINSIGHT WITHIN THE 1 YEAR WARRANTY PERIOD SHALL BE LIMITED TO REPLACEMENT OF THE SOFTWARE. IN NO EVENT WILL ROGUE OR ITS SUPPLIERS BE LIABLE TO YOU, YOUR STAFF OR CUSTOMERS FOR ANY CONSEQUENTIAL, INCIDENTAL OR SPECIAL DAMAGES, INCLUDING ANY LOST PROFITS OR LOST SAVINGS, EVEN IF A ROGUE REPRESENTATIVE HAS BEEN ADVISED OF THE POSSIBILITY OF SUCH DAMAGES, OR FOR ANY CLAIM BY ANY THIRD PARTY.

BRAINSIGHT IS A RESEARCH APPLICATION, AND HAS NOT BEEN APPROVED FOR ANY APPLICATION BY ANY MEDICAL AUTHORITY. IT IS THE RESPONSIBILITY OF

THE END-USER TO ENSURE THAT BRAINSIGHT IS USED IN ACCORDANCE ANY APPLICABLE LAWS.

#### 1. License

The software accompanying this License, whether on compact disc or any other media, the related documentation and other materials (collectively, "Brainsight Software") are licensed, not sold, to you by Rogue Research Inc. ("Rogue"). The Brainsight Software in this package and any copies which this agreement authorizes you to make are subject to this License. The Brainsight Software accompanying this License includes third party open source and other commercial software whose use is governed exclusively by the terms of their respective licenses.

#### 2. Permitted Uses and Restrictions

You may install the Software on up to 10 computers, so long as they are all associated with the license owner. For example, a lab member who wishes to install the Software on his laptop for the purposes of preparing or reviewing data acquired by this system.

- You may use Brainsight for investigational use.
- You may not use Brainsight for therapeutic or diagnostic applications or for surgical guidance involving humans.

### 3. Copyright

The Software is owned by Rogue and its suppliers, and its structure, organization and code are the valuable trade secrets of Rogue and its suppliers. The Software is also protected by Canadian Copyright Law and International Treaty provisions. You must treat the Software just as you would any other copyrighted material, such as a book. You may not copy the Software or the Documentation, except as set forth in the "Permitted Uses and Restrictions" section. Any copies that you are permitted to make pursuant to this Agreement must contain the same copyright and other proprietary notices that appear on or in the Software. You agree not to modify, adapt, translate, reverse engineer, decompile, disassemble or otherwise attempt to discover the source code of the Software, except in the case of included third party software where such rights are expressly granted by their respective licenses. Trademarks shall be used in accordance with accepted trademark practice, including identification of trademark owner's name. Trademarks can only be used to identify printed output produced by the Software. Such use of any trademark does not give you any rights of ownership in that trademark. Except as stated above, this Agreement does not grant you any intellectual property rights in the Software.

### 4. Transfer

You may not rent, lease, sublicense or lend the Software or Documentation. You may, however, transfer all your rights to use the Software to another person or legal

entity provided that you transfer this Agreement, the Software, including all copies, updates and prior versions, and all Documentation to such person or entity and that you retain no copies, including copies stored on a computer.

### Trademarks

Brainsight® is a trademark of Rogue Research, Inc. Polaris® and Vicra™ are registered trademarks of Northern Digital, Inc. Macintosh®, Mac OS X® and QuickTime® are registered trademarks of Apple Computer, Inc. Intel® is a registered trademark of Intel Corporation or its subsidiaries in the United States and other countries.

### COMPONENT LICENSE AGREEMENTS

Brainsight 2 employs several open-source components and we have contributed to many of these through development and testing of new features (both automated and manual). The license agreements of each open-source components are printed here in compliance with their respective license agreements.

### VTK

VTK is an open-source toolkit licensed under the BSD license.

Copyright (c) 1993-2008 Ken Martin, Will Schroeder, Bill Lorensen

All rights reserved.

Redistribution and use in source and binary forms, with or without modification, are permitted provided that the following conditions are met:

- Redistributions of source code must retain the above copyright notice, this list of conditions and the following disclaimer.
- Redistributions in binary form must reproduce the above copyright notice, this list of conditions and the following disclaimer in the documentation and/or other materials provided with the distribution.
- Neither name of Ken Martin, Will Schroeder, or Bill Lorensen nor the names of any contributors may be used to endorse or promote products derived from this software without specific prior written permission.

THIS SOFTWARE IS PROVIDED BY THE COPYRIGHT HOLDERS AND CONTRIBUTORS "AS IS" AND ANY EXPRESS OR IMPLIED WARRANTIES, INCLUDING, BUT NOT LIMITED TO, THE IMPLIED WARRANTIES OF MERCHANTABILITY AND FITNESS FOR A PARTICULAR PURPOSE ARE DISCLAIMED. IN NO EVENT SHALL THE AUTHORS OR CONTRIBUTORS BE LIABLE FOR ANY DIRECT, INDIRECT, INCIDENTAL, SPECIAL, EXEMPLARY, OR CONSEQUENTIAL DAMAGES (INCLUDING, BUT NOT LIMITED TO, PROCUREMENT OF SUBSTITUTE GOODS OR SERVICES; LOSS OF USE, DATA, OR PROFITS; OR BUSINESS INTERRUPTION) HOWEVER CAUSED AND ON



ANY THEORY OF LIABILITY, WHETHER IN CONTRACT, STRICT LIABILITY, OR TORT (INCLUDING NEGLIGENCE OR OTHERWISE) ARISING IN ANY WAY OUT OF THE USE OF THIS SOFTWARE, EVEN IF ADVISED OF THE POSSIBILITY OF SUCH DAMAGE.

### **ITK**

NumFOCUS holds the copyright of this software. NumFOCUS is a non-profit entity that promotes the use of open source scientific software for educational and research purposes. NumFOCUS delegates project governance to the Insight Software Consortium Council, an educational consortium dedicated to promoting and maintaining open-source, freely available software for medical image analysis.

The software is distributed as open source under an OSI-approved license. Starting with ITK 4.0, the Apache 2.0 license is used. For versions prior and including 3.20, the new and simplified BSD license is used. Before 3.6, a variation of the BSD license is used.

### **GDCM**

Copyright (c) 2006–2011 Mathieu Malaterre

Copyright (c) 1993–2005 CREATIS

(CREATIS = Centre de Recherche et d'Applications en Traitement de l'Image)

All rights reserved.

Redistribution and use in source and binary forms, with or without

modification, are permitted provided that the following conditions are met:

- Redistributions of source code must retain the above copyright notice, this list of conditions and the following disclaimer.

- Redistributions in binary form must reproduce the above copyright notice, this list of conditions and the following disclaimer in the documentation and/or other materials provided with the distribution.

- Neither name of Mathieu Malaterre, or CREATIS, nor the names of any contributors (CNRS, INSERM, UCB, Universite Lyon I), may be used to endorse or promote products derived from this software without specific prior written permission.

THIS SOFTWARE IS PROVIDED BY THE COPYRIGHT HOLDERS AND CONTRIBUTORS "AS IS" AND ANY EXPRESS OR IMPLIED WARRANTIES, INCLUDING, BUT NOT LIMITED TO, THE IMPLIED WARRANTIES OF MERCHANTABILITY AND FITNESS FOR A PARTICULAR PURPOSE ARE DISCLAIMED. IN NO EVENT SHALL THE AUTHORS OR CONTRIBUTORS BE LIABLE FOR ANY DIRECT, INDIRECT, INCIDENTAL, SPECIAL, EXEMPLARY, OR CONSEQUENTIAL DAMAGES (INCLUDING, BUT NOT LIMITED TO, PROCUREMENT OF SUBSTITUTE GOODS OR SERVICES; LOSS OF USE, DATA, OR PROFITS; OR BUSINESS INTERRUPTION) HOWEVER CAUSED AND ON ANY THEORY OF LIABILITY, WHETHER IN CONTRACT, STRICT LIABILITY, OR TORT (INCLUDING NEGLIGENCE

OR OTHERWISE) ARISING IN ANY WAY OUT OF THE USE OF THIS SOFTWARE, EVEN IF ADVISED OF THE POSSIBILITY OF SUCH DAMAGE.

### **OpenCV**

Copyright 2000–2022 Intel Corporation, OpenCV Foundation, and others

Licensed under the Apache License, Version 2.0 (the "License"); you may not use this file except in compliance with the License.

You may obtain a copy of the License at

<http://www.apache.org/licenses/LICENSE-2.0>

Unless required by applicable law or agreed to in writing, software distributed under the License is distributed on an "AS IS" BASIS, WITHOUT WARRANTIES OR CONDITIONS OF ANY KIND, either express or implied. See the License for the specific language governing permissions and limitations under the License.

### **AMSerialPort**

Copyright © 2009, Andreas Mayer

All rights reserved.

Redistribution and use in source and binary forms, with or without modification, are permitted provided that the following conditions are met:

- Redistributions of source code must retain the above copyright notice, this list of conditions and the following disclaimer.

- Redistributions in binary form must reproduce the above copyright notice, this list of conditions and the following disclaimer in the documentation and/or other materials provided with the distribution.

- Neither the name of Andreas Mayer nor the names of its contributors may be used to endorse or promote products derived from this software without specific prior written permission.

THIS SOFTWARE IS PROVIDED BY THE COPYRIGHT HOLDERS AND CONTRIBUTORS "AS IS" AND ANY EXPRESS OR IMPLIED WARRANTIES, INCLUDING, BUT NOT LIMITED TO, THE IMPLIED WARRANTIES OF MERCHANTABILITY AND FITNESS FOR A PARTICULAR PURPOSE ARE DISCLAIMED. IN NO EVENT SHALL THE COPYRIGHT HOLDER OR CONTRIBUTORS BE LIABLE FOR ANY DIRECT, INDIRECT, INCIDENTAL, SPECIAL, EXEMPLARY, OR CONSEQUENTIAL DAMAGES (INCLUDING, BUT NOT LIMITED TO, PROCUREMENT OF SUBSTITUTE GOODS OR SERVICES; LOSS OF USE, DATA, OR PROFITS; OR BUSINESS INTERRUPTION) HOWEVER CAUSED AND ON ANY THEORY OF LIABILITY, WHETHER IN CONTRACT, STRICT LIABILITY, OR TORT (INCLUDING NEGLIGENCE OR OTHERWISE) ARISING IN ANY WAY OUT OF THE USE OF THIS SOFTWARE, EVEN IF ADVISED OF THE POSSIBILITY OF SUCH DAMAGE.

#### **Remote Control Wrapper**

Copyright (c) 2006-2014 Martin Kahr

MIT Style License

Permission is hereby granted, free of charge, to any person obtaining a copy of this software and associated documentation files (the "Software"), to deal in the Software without restriction, including without limitation the rights to use, copy, modify, merge, publish, distribute, sublicense, and/or sell copies of the Software, and to permit persons to whom the Software is furnished to do so, subject to the following conditions:

The above copyright notice and this permission notice shall be included in all copies or substantial portions of the Software.

THE SOFTWARE IS PROVIDED "AS IS", WITHOUT WARRANTY OF ANY KIND, EXPRESS OR IMPLIED, INCLUDING BUT NOT LIMITED TO THE WARRANTIES OF MERCHANTABILITY, FITNESS FOR A PARTICULAR PURPOSE AND NONINFRINGEMENT. IN NO EVENT SHALL THE AUTHORS OR COPYRIGHT HOLDERS BE LIABLE FOR ANY CLAIM, DAMAGES OR OTHER LIABILITY, WHETHER IN AN ACTION OF CONTRACT, TORT OR OTHERWISE, ARISING FROM, OUT OF OR IN CONNECTION WITH THE SOFTWARE OR THE USE OR OTHER DEALINGS IN THE SOFTWARE.

#### **FeedbackReporter**

Copyright 2008-2019 Torsten Curdt

Licensed under the Apache License, Version 2.0 (the "License"); you may not use this file except in compliance with the License.

You may obtain a copy of the License at

<http://www.apache.org/licenses/LICENSE-2.0>

Unless required by applicable law or agreed to in writing, software distributed under the License is distributed on an "AS IS" BASIS, WITHOUT WARRANTIES OR CONDITIONS OF ANY KIND, either express or implied. See the License for the specific language governing permissions and limitations under the License.

#### **libusb**

GNU LESSER GENERAL PUBLIC LICENSE (LGPL) 2.1

GNU LESSER GENERAL PUBLIC LICENSE TERMS AND CONDITIONS FOR COPYING, DISTRIBUTION AND MODIFICATION

0. This License Agreement applies to any software library or other program which contains a notice placed by the copyright holder or other authorized party saying it may be distributed under the terms of this Lesser General Public License (also called "this License").

Each licensee is addressed as "you".

A "library" means a collection of software functions and/or data prepared so as to be conveniently linked with application programs (which use some of those functions and data) to form executables.

The "Library", below, refers to any such software library or work which has been distributed under these terms. A "work based on the Library" means either the Library or any derivative work under copyright law: that is to say, a work containing the Library or a portion of it,

either verbatim or with modifications and/or translated straightforwardly into another language. (Hereinafter, translation is included without limitation in the term "modification".)

"Source code" for a work means the preferred form of the work for making modifications to it. For a library, complete source code means all the source code for all modules it contains, plus any associated interface definition files, plus the scripts used to control compilation and installation of the library.

Activities other than copying, distribution and modification are not covered by this License; they are outside its scope. The act of running a program using the Library is not restricted, and output from such a program is covered only if its contents constitute a work based on the Library (independent of the use of the Library in a tool for writing it). Whether that is true depends on what the Library does and what the program that uses the Library does.

1. You may copy and distribute verbatim copies of the Library's complete source code as you receive it, in any medium, provided that you conspicuously and appropriately publish on each copy an appropriate copyright notice and disclaimer of warranty; keep intact all the notices that refer to this License and to the absence of any warranty; and distribute a copy of this License along with the Library.

You may charge a fee for the physical act of transferring a copy, and you may at your option offer warranty protec-

tion in exchange for a fee.

2. You may modify your copy or copies of the Library or any portion of it, thus forming a work based on the Library, and copy and distribute such modifications or work under the terms of Section 1 above, provided that you also meet all of these conditions:

a) The modified work must itself be a software library.

b) You must cause the files modified to carry prominent notices stating that you changed the files and the date of any change.

c) You must cause the whole of the work to be licensed at no charge to all third parties under the terms of this License.

d) If a facility in the modified Library refers to a function or a table of data to be supplied by an application program that uses the facility, other than as an argument passed when the facility is invoked, then you must make a good faith effort to ensure that, in the event an application does not supply such function or table, the facility still operates, and performs whatever part of its purpose remains meaningful. (For example, a function in a library to compute square roots has a purpose that is entirely well-defined independent of the application. Therefore, Subsection 2d requires that any application-supplied function or table used by this function must be optional: if the application does not supply it, the square root function must still compute square roots.)

These requirements apply to the modified work as a whole. If identifiable sections of that work are not derived from the Library, and can be reasonably considered independent and separate works in themselves, then this License, and its terms, do not apply to those sections when you distribute them as separate works. But when you distribute the same sections as part of a whole which is a work based on the Library, the distribution of the whole must be on the terms of this License, whose permissions for other licensees extend to the entire whole, and thus to each and every part regardless of who wrote it. Thus, it is not the intent of this section to claim rights or contest your rights to work written entirely by you; rather, the intent is to exercise the right to control the distribution of derivative or collective works based on the Library.

In addition, mere aggregation of another work not based on the Library with the Library (or with a work based on the Library) on a volume of a storage or distribution medium does not bring the other work under the scope of this License.

3. You may opt to apply the terms of the ordinary GNU General Public License instead of this License to a given copy of the Library. To do this, you must alter all the notices that refer to this License, so that they refer to the ordinary GNU General Public License, version 2, instead of to this License. (If a newer version than version 2 of the ordinary GNU General Public License has appeared, then you can specify that version instead if you wish.) Do

not make any other change in these notices.

Once this change is made in a given copy, it is irreversible for that copy, so the ordinary GNU General Public License applies to all subsequent copies and derivative works made from that copy.

This option is useful when you wish to copy part of the code of the Library into a program that is not a library.

4. You may copy and distribute the Library (or a portion or derivative of it, under Section 2) in object code or executable form under the terms of Sections 1 and 2 above provided that you accompany it with the complete corresponding machine-readable source code, which must be distributed under the terms of Sections 1 and 2 above on a medium customarily used for software interchange.

If distribution of object code is made by offering access to copy from a designated place, then offering equivalent access to copy the source code from the same place satisfies the requirement to distribute the source code, even though third parties are not compelled to copy the source along with the object code.

5. A program that contains no derivative of any portion of the Library, but is designed to work with the Library by being compiled or linked with it, is called a “work that uses the Library”. Such a work, in isolation, is not a derivative work of the Library, and therefore falls outside the scope of this License.

However, linking a “work that uses the Library” with

the Library creates an executable that is a derivative of the Library (because it contains portions of the Library), rather than a “work that uses the library”. The executable is therefore covered by this License. Section 6 states terms for distribution of such executables.

When a “work that uses the Library” uses material from a header file that is part of the Library, the object code for the work may be a derivative work of the Library even though the source code is not. Whether this is true is especially significant if the work can be linked without the Library, or if the work is itself a library. The threshold for this to be true is not precisely defined by law. If such an object file uses only numerical parameters, data structure layouts and accessors, and small macros and small inline functions (ten lines or less in length), then the use of the object file is unrestricted, regardless of whether it is legally a derivative work. (Executables containing this object code plus portions of the Library will still fall under Section 6.) Otherwise, if the work is a derivative of the Library, you may distribute the object code for the work under the terms of Section 6. Any executables containing that work also fall under Section 6, whether or not they are linked directly with the Library itself.

6. As an exception to the Sections above, you may also combine or link a “work that uses the Library” with the Library to produce a work containing portions of the Library, and distribute that work under terms of your choice, provided that the terms permit modification of the work for the customer’s own use and reverse engineering

for debugging such modifications. You must give prominent notice with each copy of the work that the Library is used in it and that the Library and its use are covered by this License. You must supply a copy of this License. If the work during execution displays copyright notices, you must include the copyright notice for the Library among them, as well as a reference directing the user to the copy of this License. Also, you must do one of these things:

a) Accompany the work with the complete corresponding machine-readable source code for the Library including whatever changes were used in the work (which must be distributed under Sections 1 and 2 above); and, if the work is an executable linked with the Library, with the complete machine-readable “work that uses the Library”, as object code and/or source code, so that the user can modify the Library and then relink to produce a modified executable containing the modified Library. (It is understood that the user who changes the contents of definitions files in the Library will not necessarily be able to recompile the application to use the modified definitions.)

b) Use a suitable shared library mechanism for linking with the Library. A suitable mechanism is one that (1) uses at run time a copy of the library already present on the user’s computer system, rather than copying library functions into the executable, and (2) will operate properly with a modified version of the library, if the user installs one, as long as the modified version is interface-compatible with the version that the work

was made with.

c) Accompany the work with a written offer, valid for at least three years, to give the same user the materials specified in Subsection 6a, above, for a charge no more than the cost of performing this distribution.

d) If distribution of the work is made by offering access to copy from a designated place, offer equivalent access to copy the above specified materials from the same place.

e) Verify that the user has already received a copy of these materials or that you have already sent this user a copy. For an executable, the required form of the “work that uses the Library” must include any data and utility programs needed for reproducing the executable from it. However, as a special exception, the materials to be distributed need not include anything that is normally distributed (in either source or binary form) with the major components (compiler, kernel, and so on) of the operating system on which the executable runs, unless that component itself accompanies the executable.

It may happen that this requirement contradicts the license restrictions of other proprietary libraries that do not normally accompany the operating system. Such a contradiction means you cannot use both them and the Library together in an executable that you distribute.

7. You may place library facilities that are a work based on the Library side-by-side in a single library together with other library facilities not covered by this License,

and distribute such a combined library, provided that the separate distribution of the work based on the Library and of the other library facilities is otherwise permitted, and provided that you do these two things:

a) Accompany the combined library with a copy of the same work based on the Library, uncombined with any other library facilities. This must be distributed under the terms of the Sections above.

b) Give prominent notice with the combined library of the fact that part of it is a work based on the Library, and explaining where to find the accompanying uncombined form of the same work.

8. You may not copy, modify, sublicense, link with, or distribute the Library except as expressly provided under this License. Any attempt otherwise to copy, modify, sublicense, link with, or distribute the Library is void, and will automatically terminate your rights under this License. However, parties who have received copies, or rights, from you under this License will not have their licenses terminated so long as such parties remain in full compliance.

9. You are not required to accept this License, since you have not signed it. However, nothing else grants you permission to modify or distribute the Library or its derivative works. These actions are prohibited by law if you do not accept this License. Therefore, by modifying or distributing the Library (or any work based on the Library), you indicate your acceptance of this License

to do so, and all its terms and conditions for copying, distributing or modifying the Library or works based on it.

10. Each time you redistribute the Library (or any work based on the Library), the recipient automatically receives a license from the original licensor to copy, distribute, link with or modify the Library subject to these terms and conditions. You may not impose any further restrictions on the recipients' exercise of the rights granted herein. You are not responsible for enforcing compliance by third parties with this License.

11. If, as a consequence of a court judgment or allegation of patent infringement or for any other reason (not limited to patent issues), conditions are imposed on you (whether by court order, agreement or otherwise) that contradict the conditions of this License, they do not excuse you from the conditions of this License. If you cannot distribute so as to satisfy simultaneously your obligations under this License and any other pertinent obligations, then as a consequence you may not distribute the Library at all. For example, if a patent license would not permit royalty-free redistribution of the Library by all those who receive copies directly or indirectly through you, then the only way you could satisfy both it and this License would be to refrain entirely from distribution of the Library.

If any portion of this section is held invalid or unenforceable under any particular circumstance, the balance of the section is intended to apply, and the section as a

whole is intended to apply in other circumstances. It is not the purpose of this section to induce you to infringe any patents or other property right claims or to contest validity of any such claims; this section has the sole purpose of protecting the integrity of the free software distribution system which is implemented by public license practices. Many people have made generous contributions to the wide range of software distributed through that system in reliance on consistent application of that system; it is up to the author/donor to decide if he or she is willing to distribute software through any other system and a licensee cannot impose that choice.

This section is intended to make thoroughly clear what is believed to be a consequence of the rest of this License.

12. If the distribution and/or use of the Library is restricted in certain countries either by patents or by copyrighted interfaces, the original copyright holder who places the Library under this License may add an explicit geographical distribution limitation excluding those countries, so that distribution is permitted only in or among countries not thus excluded. In such case, this License incorporates the limitation as if written in the body of this License.

13. The Free Software Foundation may publish revised and/or new versions of the Lesser General Public License from time to time. Such new versions will be similar in spirit to the present version, but may differ in detail to address new problems or concerns. Each version is given a distinguishing version number. If the Library specifies

a version number of this License which applies to it and “any later version”, you have the option of following the terms and conditions either of that version or of any later version published by the Free Software Foundation. If the Library does not specify a license version number, you may choose any version ever published by the Free Software Foundation.

14. If you wish to incorporate parts of the Library into other free programs whose distribution conditions are incompatible with these, write to the author to ask for permission. For software which is copyrighted by the Free Software Foundation, write to the Free Software Foundation; we sometimes make exceptions for this. Our decision will be guided by the two goals of preserving the free status of all derivatives of our free software and of promoting the sharing and reuse of software generally.

#### NO WARRANTY

15. BECAUSE THE LIBRARY IS LICENSED FREE OF CHARGE, THERE IS NO WARRANTY FOR THE LIBRARY, TO THE EXTENT PERMITTED BY APPLICABLE LAW. EXCEPT WHEN OTHERWISE STATED IN WRITING THE COPYRIGHT HOLDERS AND/OR OTHER PARTIES PROVIDE THE LIBRARY “AS IS” WITHOUT WARRANTY OF ANY KIND, EITHER EXPRESSED OR IMPLIED, INCLUDING, BUT NOT LIMITED TO, THE IMPLIED WARRANTIES OF MERCHANTABILITY AND FITNESS FOR A PARTICULAR PURPOSE. THE ENTIRE RISK AS TO THE QUALITY AND PERFORMANCE OF THE LIBRARY IS WITH YOU. SHOULD THE LIBRARY PROVE DEFECTIVE, YOU ASSUME

THE COST OF ALL NECESSARY SERVICING, REPAIR OR CORRECTION.

16. IN NO EVENT UNLESS REQUIRED BY APPLICABLE LAW OR AGREED TO IN WRITING WILL ANY COPYRIGHT HOLDER, OR ANY OTHER PARTY WHO MAY MODIFY AND/OR REDISTRIBUTE THE LIBRARY AS PERMITTED ABOVE, BE LIABLE TO YOU FOR DAMAGES, INCLUDING ANY GENERAL, SPECIAL, INCIDENTAL OR CONSEQUENTIAL DAMAGES ARISING OUT OF THE USE OR INABILITY TO USE THE LIBRARY (INCLUDING BUT NOT LIMITED TO LOSS OF DATA OR DATA BEING RENDERED INACCURATE OR LOSSES SUSTAINED BY YOU OR THIRD PARTIES OR A FAILURE OF THE LIBRARY TO OPERATE WITH ANY OTHER SOFTWARE), EVEN IF SUCH HOLDER OR OTHER PARTY HAS BEEN ADVISED OF THE POSSIBILITY OF SUCH DAMAGES.

#### **Labjack exodriver**

All exodriver library and example source code are licensed under MIT X11.

Copyright (c) 2009 LabJack Corporation <support@labjack.com>

Permission is hereby granted, free of charge, to any person obtaining a copy of this software and associated documentation files (the “Software”), to deal in the Software without restriction, including without limitation the right to use, copy, modify, merge, publish, distribute, sublicense, and/or sell copies of the Software, and to permit persons to whom the Software is furnished to do

so, subject to the following conditions:

The above copyright notice and this permission notice shall be included in all copies or substantial portions of the Software.

THE SOFTWARE IS PROVIDED "AS IS", WITHOUT WARRANTY OF ANY KIND, EXPRESS OR IMPLIED, INCLUDING BUT NOT LIMITED TO THE WARRANTIES OF MERCHANTABILITY, FITNESS FOR A PARTICULAR PURPOSE AND NONINFRINGEMENT. IN NO EVENT SHALL THE AUTHORS OR COPYRIGHT HOLDERS BE LIABLE FOR ANY CLAIM, DAMAGES OR OTHER LIABILITY, WHETHER IN AN ACTION OF CONTRACT, TORT OR OTHERWISE, ARISING FROM, OUT OF OR IN CONNECTION WITH THE SOFTWARE OR THE USE OR OTHER DEALINGS IN THE SOFTWARE.

```
# CocoaAsyncSocket
```

This class is in the public domain.

Originally created by Robbie Hanson in Q3 2010.

Updated and maintained by Deusty LLC and the Apple development community.

```
# GCUndoManager
```

Copyright 2009-2014 Apptree.net. All rights reserved.

Creative Commons Attribution-ShareAlike 2.5 license.

```
# Quesa
```

Quesa is distributed under the BSD License and is Copyright © 1999-2005, Quesa Developers. For some background information about this license, you may wish

to visit this web site.

The BSD license allows you to link Quesa into your software, as either a static or dynamic library, with no obligation. You may not redistribute Quesa without preserving its copyright statement.

Although not a requirement, we would prefer that any local customisations you make to Quesa are made available to the project. This ensures that your changes are carried forward into future releases of Quesa, and will be maintained as part of normal development.

Redistribution and use in source and binary forms, with or without modification, are permitted provided that the following conditions are met:

- Redistributions of source code must retain the above copyright notice, this list of conditions and the following disclaimer.

- Redistributions in binary form must reproduce the above copyright notice, this list of conditions and the following disclaimer in the documentation and/or other materials provided with the distribution.

- Neither the name of Quesa nor the names of its contributors may be used to endorse or promote products derived from this software without specific prior written permission.

THIS SOFTWARE IS PROVIDED BY THE COPYRIGHT HOLDERS AND CONTRIBUTORS "AS IS" AND ANY

EXPRESS OR IMPLIED WARRANTIES, INCLUDING, BUT NOT LIMITED TO, THE IMPLIED WARRANTIES OF MERCHANTABILITY AND FITNESS FOR A PARTICULAR PURPOSE ARE DISCLAIMED. IN NO EVENT SHALL THE COPYRIGHT OWNER OR CONTRIBUTORS BE LIABLE FOR ANY DIRECT, INDIRECT, INCIDENTAL, SPECIAL, EXEMPLARY, OR CONSEQUENTIAL DAMAGES (INCLUDING, BUT NOT LIMITED TO, PROCUREMENT OF SUBSTITUTE GOODS OR SERVICES; LOSS OF USE, DATA, OR PROFITS; OR BUSINESS INTERRUPTION) HOWEVER CAUSED AND ON ANY THEORY OF LIABILITY, WHETHER IN CONTRACT, STRICT LIABILITY, OR TORT (INCLUDING NEGLIGENCE OR OTHERWISE) ARISING IN ANY WAY OUT OF THE USE OF THIS SOFTWARE, EVEN IF ADVISED OF THE POSSIBILITY OF SUCH DAMAGE.

#### **MNI 152 Average Brain (used in MNI-based projects)**

Copyright (C) 1993–2009 Louis Collins, McConnell Brain Imaging Centre, Montreal Neurological Institute, McGill University. Permission to use, copy, modify, and distribute this software and its documentation for any purpose and without fee is hereby granted, provided that the above copyright notice appear in all copies. The authors and McGill University make no representations about the suitability of this software for any purpose. It is provided "as is" without express or implied warranty. The authors are not responsible for any data loss, equipment damage, property loss, or injury to subjects or patients resulting from the use or misuse of this software package.

## Warnings and Cautions

Always connect the power cable to the Polaris optical position sensor while its power switch is OFF (or in the case of the Vicra, with the power cable un-plugged). Failure to do so may cause serious damage to the Polaris camera.

## Change Log

**Note: the project file format has changed (if migrating from 2.4 or earlier). Brainsight 2.5.x can open documents created by older versions of Brainsight, but older versions of Brainsight cannot open documents created by Brainsight 2.5.x.**

Changes in version 2.5.8 (since 2.5.7): (2025-03-28)

- Fixed a bug in the 'response:select-target-in-session', 'response:list-session-targets', 'response:create-sample', 'stream:sample-creation', and 'stream:sample-emg' packets where the 'coordinate-system' field behaved as intended, but the 'position' field was always in Brainsight coordinates instead of the indicated coordinate system.
- Fixed miscellaneous bugs.

Changes in version 2.5.7 (since 2.5.6): (2025-02-26)

- Fixed a bug in the 'create-target-at-location' packet in the network protocol where the reported index path of the created target would (usually) be incorrect if there were any folders amongst the session's

targets.

- Changed the 'create-target-at-location' packet in the network protocol to allow the target position to be unspecified, in which case the target will be positioned at the current crosshairs position in the Session Perform window.
- When exporting curvilinear reconstructions to a file, they are now always coloured using the anatomical's voxels. For curvilinears created from ROI, this is a bug fix because previously they weren't being coloured at all. For curvilinears from overlays, this is a behaviour change as they were previously coloured from the overlay they were created from.
- Fixed miscellaneous bugs.

Changes in version 2.5.6 (since 2.5.5): (2025-01-24)

- Brainsight can now act as a TCP/IP network server, and accept connections from one or more client applications. Clients can request that Brainsight perform certain actions, and Brainsight can inform clients when certain events occur. We provide documentation for the network communication protocol and sample Python code. (This feature requires at least macOS 10.14, and 10.15 for full functionality.)
- Oblique images (inline, inline 90, and perpendicular) use a better interpolation algorithm and thus now appear less grainy.
- Fixed a bug where long EMG channel names (from

NEURO PRAX) were sometimes truncated in the legend.

- Improved error messages when connection to a network-based Polaris fails.
- Fixed miscellaneous bugs.

Changes in version 2.5.5 (since 2.5.4): (2024-11-22)

- Made substantial improvements to Vet Robot tool calibration. The workflow is mostly the same except that you no longer need to identify the tool tip and shaft in both cameras simultaneously, you can instead do so in one camera at a time, which is helpful as the camera field of view is small and it can be hard to position a tool to be visible in both simultaneously. The algorithm that calculates the tool calibration is also much improved, giving more accurate tool calibrations.
- Improved Vet Robot tool-relative movement user interface to be more intuitive, and consistently move and rotate the tool around its axes: injection/retraction, left/right, forward/backward. Previously, the behaviour was not predictable.
- Vet Robot target reachability checks now have the option of checking that not only is the target itself reachable, but that a few millimetres deeper is also reachable. A new textfield in the Perform window allows setting this amount.
- Improved Vet Robot stereo calibration for small animal systems, to better cover the cameras' field of



view.

- Fixed a rare bug where Vet Robot stereo calibration could get stuck in an infinite loop.
- When importing targets from a text file, if the coordinate system name is set to "Relative", the positions in the file can be interpreted as relative to another (already-existing) target.
- Fixed a bug where projects based on a SimNIBS .gmsh file could get the NIFTI sform and qform confused and result in an error message when invoking BabelBrain to perform a TMS simulation.
- Fixed a bug where Polaris tool tracking could sometimes show the subject tracker move with respect to the subject's head. This was merely a visual glitch, and did not affect correctness.
- Improved performance working with many targets (example: big grids).
- Improved performance working with many electrodes (example: big EEG/NIRS caps).
- Improved performance opening .dxf files.
- The Polaris firmware version number is now shown in the Polaris Configuration window.
- In waveform views, when in staggered mode, you can now click a waveform to get a tooltip showing the channel name.
- Fixed a crash opening corrupt project files.
- Fixed a bug where recalibrating a NIRS block would

program an incorrect version number into the block's memory.

- Fixed a bug where the bullseye view would show a TMS coil in the background when a fUS tool was being used.
- Fixed a bug where the Vet Robot firmware version number would sometimes be displayed incorrectly.
- Fixed a bug where changing a sample's EMG peak-to-peak value or its "contribute" checkbox would fail to refresh the sample's colour in 2D and 3D views.
- Fixed a bug where changing the time index in a 4D overlay would sometimes fail to refresh 2D and 3D views.
- Fixed a bug where, if there were multiple surface reconstructions, changing the colour or other attribute of one would sometimes fail to refresh 3D views.
- Fixed a bug where, if there were multiple curvilinear reconstructions, changing the peel depth of one would sometimes fail to refresh 3D views.
- Fixed miscellaneous bugs.

Changes in version 2.5.4 (since 2.5.3): (2024-06-26)

- Moved some user interface controls from the bottom to the top of the window, namely the 3D Crosshairs and Driver popup buttons. This gives more vertical space for images and makes the contents of the popup menu less likely to overflow.

- Added a new option in the Trigger Options window to allow creating samples even when the relevant Polaris tools are not visible (by default samples cannot be created when, for example, the coil tracker is not visible.)
- Now default to looking for SimNIBS 4.1 (newest at time of writing), instead of 4.0. If you have an older (or newer) version, adjust the path in Brainsight > Settings.
- Added a fourth set of tool-relative Vet Robot movement controls that only have buttons to inject and retract the tool. The controls that allow the more dangerous tool-relative rotations are now separated in a different pane.
- No longer allow Vet Robot to move to a marker-type target, only to trajectory-type targets. This is a safety precaution because, although markers technically have an orientation, it's not displayed, and so the robot risks moving in an unexpected direction.
- Fixed a bug where Vet Robot subject registration would fail if the skull reconstruction was not watertight and consisted of several disjoint pieces and one of the initial registration landmarks was touching a secondary piece.
- For Vet Robot sessions, the default threshold range in the Validation step was tightened from 0.5 to 0.3 mm, reflecting recent improvements in system accuracy.

- Made various improvements for Axilum Robot / Cobot support:
  - An error message is now shown if the Cobot is not in MCP (manual control panel) mode.
  - Added functionality to switch Cobot sides.
  - The force sensor check procedure must now be redone if the coil is changed.
  - Coil names are now partly anonymized, to no longer reveal if a sham coil is being used (to help with blind studies).
  - Extended the range of the contact sensor sensitivity.
- The Polaris Lyra is now configured to track at 30 Hz instead of 20 Hz.
- Fixed a bug where a bumps to a Polaris were not reported.
- Fixed a bug that could result in a failure to read some valid NIFTI files, for example those generated by BabelBrain.
- Fixed a bug where vector field arrows (for TMS simulation for example) sometimes did not display when they should have.
- Fixed a bug where 4D datasets with exactly 4 time components would be interpreted and drawn as vector fields.
- Added a new fUS transducer option for 3D Cross-hairs shape.

- Added a new button next to the scene selection popup menu to quickly customize a view.
- A TMS coil is no longer shown in bullseye views when the selected tool calibration is fUS-type.
- Creating a surface/skin reconstruction is now about 25% faster.
- Creating a curvilinear reconstruction is now about 35% faster.
- Fixed various crashes that could occur opening corrupt files.
- Fixed miscellaneous bugs.

#### Changes in version 2.5.3 (since 2.5.2): (2024-03-01)

- Brainsight can now simulate the acoustic effect of transcranial focused ultrasound (fUS) at a target location. It does this by interacting with BabelBrain, a third party software that must be installed separately. The Targets window now allows invoking BabelBrain, wherein simulation parameters can be set. The resulting simulation appears overlaid in 2D and 3D images, and can be customized from the Inspector window.
- When writing to our .txt file formats, we now use slightly different coordinate system names for NIFTI files, which may require updating code that reads these files. The coordinate system name now includes whether it's from the file's sform or qform. So, for example, where we used to use a string

like "NIFTI:Scanner" we now use "NIFTI:Q:Scanner". For this reason, exported .txt files increased from version 13 to 14, and .txt files created by streaming increased from version 6 to 7.

- Improved performance when creating hundreds of samples. There should be noticeably less latency between the trigger that creates a sample and its appearance in the application.
- Substantially improved accuracy of Vet Robot subject registration, thus improving accuracy results overall.
- Fixed a bug, introduced only in 2.5.2, where selecting two or more samples was not showing the average waveform for EEG and NIRS views (but was for EMG views).
- Fixed a bug where EMG waveform views sometimes did not show the visual indication (crosshatching) of when a waveform has exceeded the EMG pod device's maximum range of 2.25 mV.
- Fixed a bug in EMG views where the line indicating the EMG latency would sometimes not redraw after the time range was changed (with the green vertical bars).
- Fixed a bug where electrodes could still be clicked in 3D views, even when all electrodes were hidden.
- Fixed miscellaneous bugs.

#### Changes in version 2.5.2 (since 2.5.1): (Sept. 2023)

- Added calculation and display of EMG latency using

the SHTE algorithm (by Šoda, Vidaković, Lorincz, Jerković, and Vujović). The Perform and Review windows now have a new optional table column that can show the latency for each sample. In addition, waveform views now draw a vertical line at the latency time. This line can be dragged to adjust the automatically computed value if it seems incorrect. Latency can also be exported to .txt files from the Review window.

- Each reconstruction can now be configured to participate in overlay blending or not. If the option is off, overlays will never be blended on that reconstruction. If the option is on, overlays will be blended atop that reconstruction, provided the overlay is enabled in the Inspector window (as usual). This option is on by default for curvilinear reconstructions, and off by default for surface reconstructions.
- A tool calibration's 4x4 matrix can now be exported to a MINC .xfm text file.
- The Vet Robot can now be moved relative to the currently used tool.
- The Session Polaris window now allows selecting the Polaris, and also has a button in bring up the Polaris Configuration window.
- More windows now have the option of showing the crosshair's numerical coordinates (at the bottom right).
- Fixed a bug where some projects with corrupt NIRS

data would fail to load.

- Fixed a longstanding bug where the brightness/contrast slider did not work in the Curvilinear From Overlay and Surface From Overlay windows when an overlay was used as the source of the reconstruction.
- Fixed a bug where Brainsight would not automatically connect to a Polaris, even if it was detected.
- Fixed a bug where some image views would stop drawing after Brainsight was running in the background.
- Fixed a crash creating motor maps on old Macs with Nvidia GPUs .
- Improved performance creating motor maps on Macs with Apple Silicon processors.
- Fixed several crashes that could occur when opening corrupt files of various formats.
- Fixed miscellaneous bugs.

Changes in version 2.5.1 (since 2.5): (2023-06-27)

- Fixed a crash in the Tool Calibrations window when using a TTL trigger to start the calibration procedure.
- There is now a user-resizable box in the ROI window to constrain the extent of the seed flood fill.
- There is a new disc shape option for targets and samples.
- Added support for the new Polaris Lyra® position

sensor.

- Fixed a bug where vector fields from SimNIBS simulations were sometimes not shown correctly in the Session Perform and Session Review windows.
- Fixed a bug where the Park and Welcome buttons to move the Axilum robot/cobot were disabled when they shouldn't have been.
- If a sample cannot be created, a brief error message is now shown.
- Improved the robustness of the Vet Robot stereo calibration procedure.
- Fixed an error in the header comments of the stream-to-file feature.
- Fixed a bug where zooming a waveform image view sometimes did not work.
- Fixed a bug where the time index of 4D datasets was not shown correctly.
- Fixed miscellaneous bugs.

Changes in version 2.5.0 (since 2.4.11): (2022-03-24)

- Note: macOS 10.13 High Sierra is now the minimum requirement, increased from macOS 10.11 El Capitan in Brainsight 2.4. For a free update, visit <https://support.apple.com/macOS/upgrade>. Contact us if you need to upgrade your Mac hardware.
- Brainsight can now simulate the induced electric field due to a TMS stimulation at a target location. It does this by interacting with SimNIBS, a third party

software that must also be installed. The Targets window now allows associating a TMS coil model and stimulation strength with each target. The resulting simulation appears overlaid in 2D and 3D images, and can be customized from the Inspector window.

- 3D reconstructions (like the skin reconstruction) are now coloured by blending any enabled overlays atop the reconstruction's own colour.
- Overlays now support time series data (though only from NIFTI and MINC2 files, not other formats). The Overlays window and Inspector window now have a new slider to choose the time offset.
- Very large datasets (with more than  $2^{31}$  voxels) can now be used.
- Made various accuracy improvements to Vet Robot stereo calibration and subject registration, resulting in more accurate targeting during surgery.
- In the Session Perform window, creating new samples is now disallowed if the relevant Polaris tools are not visible.
- In the Session Perform window, the 'stream to file' feature now includes EMG waveform data and the coordinate system for selected targets and created samples.
- In the Session Perform window, the 'Sample Now' button is now disabled if the required tools are not visible to the Polaris camera.
- When working with the Axilum robot/cobot, a new 'scalp offset' distance can be specified to keep the TMS coil a few millimetres above the scalp to account for the thickness of an EEG cap for example.
- EMG waveform views now visually indicate when a waveform has exceeded the EMG pod device's maximum range of 2.25 mV.
- Added support for the Cornell University (Johnson, Philippa J; Barry, Erica F) canine atlas.
- Fixed various bugs with some DICOM datasets, where images would appear split in half, have gaps, or have missing slices.
- Fixed a longstanding bug where reconstructions based on ROIs would claim that re-computation was necessary, even though the ROI hadn't changed. (This was partly fixed in 2.4, but still occurred for re-opened projects.)
- ROIs can now be created by importing from a medical image file (DICOM, NIFTI, MINC, etc.).
- Fixed a bug in the ROI window where the pencil and eraser tools would not work correctly at the edge of view, especially when moving the mouse quickly.
- NIRS waveforms can be imported from a .nirs file, thus allowing importing data from other manufacturers' NIRS devices.
- Fixed a bug (introduced in Brainsight 2.4.11) where the SD.SrcPos and SD.SrcPos3D fields in exported .nirs files were swapped.
- Fixed a bug (introduced in Brainsight 2.4.5) where the SD.SrcPos field in exported .nirs files were in decimetres instead of centimetres. (The SD.SrcPos3D field was exported correctly in millimetres though.)
- Assembly Lists and Cap Layouts can now be created by importing from a .nirs file.
- Calibrating a TMS coil or other tool now allows for the tool tracker and calibration tracker to move together (relative to the camera), instead of failing if either tool moved relative to the camera.
- Polaris tool visibility status now uses a larger coloured area, making it more visible from farther away.
- The enabled/disabled state of Polaris tools in the Polaris Configuration window are now remembered across quit/relaunch.
- Landmarks, targets, electrodes, and samples can now be clicked in 3D image views to select the corresponding item in the related table view.
- Targets can now be exported to a text file from the Targets window (export was previously possible, but only from the Session Review window).
- In the Targets window, if a reconstruction is chosen in the 'optimize traj. to' popup menu, clicking in 2D views no longer reorients crosshairs.
- Exporting curvilinear reconstructions in the PLY format now includes the voxel values in greyscale, whereas previously no colour was exported, only the

shape.

- When exporting reconstructions as STL, VTK, and PLY you can now choose between the ASCII and binary variants of these file formats.
- When importing a reconstruction from file, the object can now be placed relative to a chosen target (useful for placing chambers for example).
- The crosshairs in 2D image views now have a small gap in the middle so as not to obscure the very thing being targeted.
- Wherever 4x4 matrices can be imported from a file, a new file format is now supported namely plain text files with 16 numbers within.
- The crosshairs offset slider now allows a large range.
- When opening a project file, if there are referenced external files (datasets, CAD files) that can't be found, the dialog that asks to find them now (by default) disables files with different names, thus making it much easier to find the correct file.
- A new preference allows changing the colours of the bullseye views, especially useful for colour blind users.
- A new preference allows changing the font size of the bullseye views.
- A new preference allows specifying default EMG baseline and trial durations that will be used when

creating new sessions.

- Native support for Apple Silicon processors.
- Improved support for macOS 11 Big Sur, macOS 12 Monterey, and macOS 13 Ventura.
- Various performance improvements:
  - Exporting DXF files is now much faster, especially for large reconstructions.
  - Updating an atlas space template overlay is now much faster.
  - Reorienting the anatomical dataset is now much faster.
  - Creating curvilinear reconstructions is now much faster.
  - Creating skin and other surface reconstructions is faster.
- Fixed miscellaneous bugs.

Changes in version 2.4.11 (since 2.4.10): (2022-07-12)

- Fixed a longstanding (but rare) crash that occurred when closing a window that contains image views.
- Fixed a bug where the name of proximity detectors was not exported correctly in .nirs files.
- Fixed a bug where macOS could warn of an expired certificate by updating our Developer ID code signing certificate.
- Updated support for newest iterations of our Vet Robot hardware, notably for the NHP 45 degree

inclination setup.

- Fixed a bug where the date/time metadata from MINC1 files would sometimes not be shown.
- Improved error checking when communicating with a Magstim TMS stimulator.
- Fixed miscellaneous bugs.

Changes in version 2.4.10 (since 2.4.9): (2022-03-01)

- Fixed a crash that could occur when computing the distance from a point to a surface, which occurs in several places, like the Targets and Session windows.
- Fixed a bug where importing a dxf file resulted in the colours being read incorrectly.
- Updated support for newest iterations of our Vet Robot hardware, notably the 50 mm lens.
- Fixed a small inaccuracy in the visual positioning of an LCT (large coil tracker) object in 3D images. (This did not affect the actual measured position of the tracker.)
- Fixed miscellaneous bugs.

Changes in version 2.4.9 (since 2.4.8): (2021-10-18)

- There is a new checkbox in the Session > IOBox step to indicate if you want to save or discard the live/full EMG waveform. It's usually not necessary to save it, because samples contain a copy of the EMG waveform just before and after the TMS pulse, and as it can grow very large it slows performance, especially saving and opening project files.

- Resuming a session no longer overwrites any existing live/full EMG waveform, instead it now appends new data to the end.
- Fixed a bug where the EMG pod was sometimes not detected between closing and resuming sessions or when disconnecting and reconnecting its USB cable.
- Fixed a bug where exporting .nirs files would fail if the project did not contain any NIRS Aux data.
- When stopping an Axilum session, we now perform an extra movement to make sure the robot arm stays in the working space.
- Fixed miscellaneous bugs.

#### Changes in version 2.4.8 (since 2.4.7): (2021-06-25)

- The Polaris Configuration window now has a new popup menu where you can choose which Polaris device to use. This is especially useful for network-based Polaris cameras, of which you may have several on your network.
- Fixed a bug where the application would sometimes become unresponsive when communicating with a Polaris Vega.
- The 'extended pyramid' volume shape supported by some Polaris Spectra and Vega cameras is now supported and will be used automatically if available.
- Fixed a bug where the NIRS Configuration window would indicate a firmware update was available

when in fact no update was available.

- The Vet Robot stereo calibration procedure was improved to capture slightly more points.
- The 'Mini TMS Coil' 3D crosshairs shape now has a slightly longer shaft.
- Fixed miscellaneous bugs.

#### Changes in version 2.4.7 (since 2.4.6): (2020-12-23)

- Added support for the new macOS 11 Big Sur, notably communication with Polaris cameras now works.
- Numerous changes to Axilum Robotics support:
- A new feature in the Session Perform window now allows visiting a sequence of targets, pausing for a specified number of TMS pulses, with a specified duration between them, and then moving to the next target.
- The "Align" buttons have changed behaviour in several notable ways:
  - They now only act on the sole selected target. They no longer can be used for a folder of targets.
  - They now move in whatever path is necessary to ultimately reach the target and always descend the coil to contact the skin. (Previously, there were two behaviours: if the coil was already on the skin, they would only try to slide along the skin, and if the target was too far, no movement would result at all. If the coil was in orbit, they would align above the

new target, but not descend to the skin.)

- To signal this behaviour change, the buttons have been renamed from "Align" to "Move".
- The "Stop" button now moves the robot arm away from the subject's head, if it was in contact.
- Closing a session window now warns if you are connected to a robot, instead of just closing.
- Added tooltips to most of the Axilum-related buttons, to help understand what they each do.
- Added a second kind of subject registration for Vet Robot sessions. Instead of using two landmarks and the laser grid, you can now use three or more landmarks for a classic rigid body registration. This requires being able to accurately locate such landmarks both on the anatomical scan and in the camera images.
- The Targets window now allows importing target names and coordinates from a text file.
- Fixed a bug where older documents sometimes failed to convert to the newest format with the message "crosshairs is a required value".
- Fixed a bug where the "switch" input on the IOBox was triggering from high to low voltage instead of low to high voltage, resulting in presses of the foot switch being recognised upon releasing the pedal instead of upon depressing the pedal.
- Fixed a crash that could occur choosing some

colours in the ROI window.

- Fixed a crash importing some SPM12 .mat files.
- Fixed a crash on macOS 10.14 and older that could occur if a TTL trigger was received while editing the peak-to-peak value in the Inspector > Motor Maps window.
- Fixed various bugs with macOS dark mode, where some things were drawn with incorrect or illegible colours.
- Fixed a bug where landmark/electrode names that contained two parts, like "LA43-LA44", would only have the first half spoken.
- The Session Validation window now allows choosing the crosshairs shape, like most other steps in the Session window.
- Fixed an old bug where the first use of the Apple Remote after booting the Mac resulted in the first button press being reacted to twice.
- Fixed a bug where the Apple Remote up and down buttons did not work on macOS 10.13 and newer.
- Fixed a bug where the Apple Remote did not work at all on macOS 10.15 and newer.
- Fixed miscellaneous bugs.

Changes in version 2.4.6 (since 2.4.5): (2020-10-21)

- The Vet Robot subject registration procedure no longer requires manually cropping the skull reconstruction, it is now done automatically.

- Vet Robot stereo calibration and subject registration calculations are now much faster.
- Judging the quality of the Vet Robot stereo calibration procedure is now easier because we now show a graphical representation of the quality of the results.
- SPM12 .mat files can now be loaded everywhere a 4x4 matrix can be loaded from file; notably this can be used for atlas space registrations.
- When exporting .txt files from the Session Review window, the option to snap samples to a reconstruction previously only snapped inwards but now it will now snap in either direction, thus working for samples created inside the head (due to use of 'crosshairs offset' slider for example).
- Fixed a bug where the NEURO PRAX impedance check failed to update the electrode colours.
- Fixed miscellaneous bugs.

Changes in version 2.4.5 (since 2.4.4): (2020-06-29)

- Fixed a crash that could occur opening projects created by older versions of Brainsight, where the project once contained NIRS data that was subsequently deleted.
- Exporting .nirs files can now include the results of any analysis that was performed.
- Exported .nirs files now contain metadata indicating that centimetres are used for positional information. This will prevent Homer2 from having to ask.

- The Vet Robot Configuration window no longer shows a ring around the flange in the camera views because the concept does not apply to the newest hardware.
- The newest version of the FTDI device driver (2.4.4) is now installed (this controls communication with RS-232 serial devices like the Polaris camera and Magstim TMS stimulator).
- Improved compatibility with macOS 10.15 Catalina by supporting 'notarization'. This eliminates the "Brainsight can't be opened because Apple cannot check it for malicious software" error message.
- Fixed miscellaneous bugs.

Changes in version 2.4.4 (since 2.4.3): (2020-04-09)

- Fixed a bug where the newly-released macOS Catalina 10.15.4, but not earlier versions, caused Brainsight to crash.
- Added support for the Logothetis / Saleem D99 Macaque atlas. (You also need to install Support Files Vet 1.3.)
- Fixed miscellaneous bugs.

Changes in version 2.4.3 (since 2.4.2): (2020-01-23)

- Reverted the updated FTDI device driver that was included in Brainsight 2.4.2 because it does not work correctly on newer versions of macOS. Now the same version that Brainsight 2.4.1 and earlier included is once again included.

#### Changes in version 2.4.2 (since 2.4.1): (2020-01-20)

- When performing coil (or tool) calibrations, relaxed the check for how much the calibration block and tool tracker moved (it became too strict in Brainsight 2.4, resulting in calibrations sometimes failing even when the trackers were reasonably still).
- When using the 'target positioning tool', targets are once again drawn semi-transparent (this broke in Brainsight 2.3.4).
- The driver for the KeySpan USB-serial adapter is no longer installed because it does not work well with recent versions of macOS. If you have the driver already installed (from a previous version of Brainsight), it won't be uninstalled, so you can continue to use it, however, we recommend contacting us for a free replacement.
- The newest version of the FTDI device driver is now installed (this controls communication with RS-232 serial devices like the Polaris camera and Magstim TMS stimulator).
- Fixed miscellaneous bugs.

#### Changes in version 2.4.1 (since 2.4): (2019-12-23)

- Improved compatibility with macOS 10.15 Catalina by supporting 'notarization'. This eliminates the "Brainsight can't be opened because Apple cannot check it for malicious software" error message.
- Fixed a bug where some Analog Receivers / EMG

Pods were not detected. We discovered that a small number of such devices were not correctly programmed by us. If this is the case for your device, when you open a session window you will receive a message explaining the situation with a button to reprogram the device correctly.

- Fixed miscellaneous bugs.

#### Changes in version 2.4 (since 2.3.12): (2019-12-06)

- Important: Brainsight 2.4 now requires Mac OS X 10.11 (El Capitan) or newer. If your Mac is reasonably recent (~2008 or newer), you only need to update the OS, see Apple's website. If your Mac is older, it's possible you might not be able to update your OS, in which case contact Rogue Research for other upgrade options.
- Note: the project file format has changed. Brainsight 2.4 can open documents created by older versions of Brainsight, but older versions of Brainsight cannot open documents created by Brainsight 2.4.
- Added various Homer2-equivalent NIRS analysis features:
  - Support for multiple conditions.
  - Onset creation:
    - From existing samples already created in the session window.
    - By pulse detection in auxiliary data (low to high, high to low, threshold with dead

time).

By manual time entry of onsets.

- Optical density calculation and visualization, both unfiltered and with low-pass, high-pass, or band-pass filtering.
- Concentration calculation and visualization of HbO, HbR, and HbT for:
  - Whole recording.
  - Block averages, with optional error bars.
  - Fast and easy recalculation when adding/removing onsets, changing baseline parameters, etc.
- Easy selection and visualization of NIRS data:
  - Clicking on 3D representation of optodes on subject head shows corresponding waveform data.
  - Clicking on waveform label selects corresponding optodes in 3D image views.
- Made many improvements to Vet Robot support:
  - Significantly improved the overall accuracy of the system.
  - Region painting of the skull in sessions is now both saved in the project and undoable.
  - In the Session window, camera image views can now be zoomed and panned like other views.
  - Vet Robot sessions can now be cloned.



- Made many improvements to Axilum Robotics support:
  - Added support for the Axilum Robotics TMS-Cobot.
  - The skin reconstruction is now shown in the Session>Axilum step.
  - Greatly improved performance of projecting targets to the skin reconstruction.
- Added support for the Polaris Vega® position sensor.
- The Session > Polaris window now shows the exact field of view shape for the Polaris Krios and Polaris Spectra, where previously it was showing the shapes of their respective predecessor models.
- Instead of a generic 'diagnostic pending' message, more exact messages are provided for various Polaris error conditions (ex: bump detected, battery fault, temperature high, etc.).
- If your Polaris' bump detector is triggered, Brainsight itself can now clear the error, obviating the need for the NDI Toolbox application.
- If the Polaris reports a dead battery or a temperature error, tool tracking will now work regardless. (You should still schedule a repair of your Polaris, as tracking accuracy may be reduced.)
- In the Session>Perform window, changing the active coil/tool calibration (from the 'driver' popup menu) now disables/enables the corresponding Polaris

tools. For example, changing from a calibration that uses CT-123 to one that uses CT-456 will stop the camera from tracking the former and start tracking the latter.

- Changed the legend in NIRS views to have a global wavelength toggle button, that applies to all pairs, instead of per-pair control of wavelength visibility.
- In 3D image views, clicking a tube that represents a NIRS pair now selects the corresponding channel in the legend of waveform views.
- Selecting a NIRS channel in the legend table or rectangles view now selects the corresponding NIRS tube in 3D image views.
- Selecting an EEG/EMG/ECG/EOG channel in the legend table now selects the corresponding electrode in 2D/3D image views.
- In sample-based waveform views, when selecting multiple samples, error bars can now optionally be shown for averages (for EEG/EMG/ECG/EOG and NIRS data).
- In sample-based waveform views, clicking a waveform now shows a tooltip that indicates which waveform the sample is from or if it is an averaged waveform.
- Waveform views now default to showing a better range of data in both the x and y axes.
- Creating an Assembly List from a .txt file now gives the option of linking it to an existing Cap Layout or

creating a new Cap Layout.

- When creating a reconstruction, you can now choose to keep only the largest piece (as opposed to previously, where all pieces were kept). This can be useful for skin reconstructions, where you don't want artifacts.
- Overlays can now be configured to colour values above/below the threshold to be either transparent (as previously) or to repeat the hi/low colour of the lookup table.
- When exporting samples into DICOM files, you can now optionally project the sample along its axis to the intersection of a chosen reconstruction (ex: the brain surface).
- The 'Manual (AC-PC+scale)' atlas space window now shows resizable lines (instead of a box) to scale the template to the subject head. This better indicates how it is meant to be used.
- Added marmoset, pig, and sheep atlases.
- Added much more information to the text file streaming feature. In addition to raw Polaris tool locations that it output before, it now logs when: the selected target changes, a TTL trigger occurs, a sample is created, the crosshairs move.
- Added buttons to the Targets and Session Perform windows to navigate up/down/left/right on a rectangular grid.
- Added a button to reorient the crosshairs to be

perpendicular to a chosen surface.

- All threshold sliders now have text fields below them so that exact ranges can be specified.
- Added a new preference to disable sounds played when creating samples or sampling landmarks.
- Partly fixed a longstanding bug where reconstructions based on ROIs would always claim that re-computation was necessary, even though the ROI hadn't changed. (This will still occur for re-opened projects though.)
- Fixed a longstanding but minor bug where the threshold mask in an ROI window did not exactly match the effect of flood fill.
- Fixed a longstanding bug where converting a sample to a target made all hidden targets become visible. Now the visibility of targets is unaffected.
- In an ROI window, the up and down arrow keys and up and down mouse wheel now move by exactly one slice, instead of by the 'slice increment size' of the Preferences window.
- In image views, the name of a landmark/target/sample can now be shown/hidden using a new button below the brightness/contrast slider.
- Changes to .txt format export:
  - The .txt file format has been changed from version 8 to 12 due to some minor changes to the file format. If you have scripts/code that reads such

files, you may need to adjust them slightly.

- When exporting EMG data, the time range used for peak-to-peak calculations is now included.
- When exporting TMS stimulation information, the Magstim® BiStim<sup>2</sup> inter-pulse duration and second power are now included.
- Fixed a bug where Magstim® BiStim<sup>2</sup> inter-pulse duration confused  $\mu$ s versus ms.
- Trackpad gestures are now supported in image views. You can now zoom with a two-finger-pinch gesture, and rotate with a two-finger-rotate gesture.
- Greatly improved performance snapping targets, grids, and electrodes to a reconstruction surface.
- Improved performance working with the Polaris.
- Improved support for non-admin macOS accounts. An admin account is still needed to install, but non-admin users can now run Brainsight.
- Improved support for macOS 10.14 Mojave and 10.15 Catalina, particularly their 'dark mode' feature.
- Fixed miscellaneous bugs.

# Chapter 1: Introduction

Welcome to Brainsight! Brainsight 2 represents the fruition of many years of effort in design and development. Brainsight 2.5 represents the latest installment in feature additions to the Brainsight 2 core. We hope that you find this new generation of neuronavigation tools useful, and as always, we value your feedback.

## HOW THIS DOCUMENT IS ORGANIZED

This document is intended to give you all the information you need to take advantage of all the features of Brainsight. The overall structure is designed to present the information in the same logical order as you would need it in the normal use of the system. There are occasions where some background information that will be useful throughout the document will be presented. These will be given in the first place where they will be needed, and usually highlighted by being in a grey box.

## Document formatting

In numerous places, you will be instructed to select menu items, or click on buttons. Rather than describing these in a “long winded ” way (e.g. “select Open... from the File menu”, or “click on the OK button”), a more concise shorthand will be used. For example, “select **File->Open**” will be used for menu selection and “click **OK**” will be used for button clicks.

## THIS USED TO BE CALLED BRAINSIGHT 2?

Brainsight 1 was introduced in 2000 and Brainsight 2 several years later. For those who have read earlier versions of this manual, we are also gradually dropping the “2” when referring to Brainsight since Brainsight 1 has long since retired so referring to Brainsight 2 specifically is becoming like referring to a car as a horseless carriage. We will continue to use the version number to refer to a specific release (e.g. 2.5 vs 2.4).

## SYSTEM REQUIREMENTS

Brainsight requires a recent Macintosh computer with the following minimum characteristics:

- Mac OS X 10.13 or greater
- Intel, Apple M1 or M2 CPU
- 8 GB RAM (16+ recommended)

If you are contemplating a new computer purchase, we recommend a computer with at least 16GB RAM (32 or more highly recommended, particularly for the M class of CPUs) and a graphics card with at least 1GB of RAM to ensure that the computer will be useful for a long time.

## HOW TO GET HELP (or HOW YOU CAN HELP US MAKE BRAINSIGHT BETTER FOR YOU)

Brainsight was designed and developed using high standards in product planning, software coding and testing. It is our expectation that on the whole, the software will work without major issues, however, you may use Brainsight in ways that we did not foresee, and encounter new issues. You can provide us with valuable feedback in the following ways:

- **Automated crash reporting**

If Brainsight crashes (“Quit unexpectedly”, or “Quit while unresponsive”), please use the Smart Crash Reports window to notify us. When an application crashes, a screen with an error message and a record of what the software was doing will appear destined for Apple. You can simply dismiss this one

(unless you suspect the issue is with macOS rather than with Brainsight) as a second one destined for Rogue Research will then appear (we get this information). Please add a brief description of what you were doing, and any information that you think might be helpful to us to reproduce the event. Finally click on the “Send to Rogue Research & Apple...” button. Several team members receive an e-mail alert and will act on it quickly. No personal information (other than the IP address of your computer) is included, so if you want us to follow-up with you regarding the crash, please include your name and e-mail in the comments, or send us an e-mail (so we know who to contact).

While Brainsight is running, help can be obtained from the help menu. It contains a link to a PDF version of the user manual, which is always up to date, and shortcuts to our support address.

- **If all else fails, e-mail [support@rogue-research.com](mailto:support@rogue-research.com).**

As with the crash reporter, several experienced people get the support e-mail so you should get a reply as soon as possible.

If you are a Brainsight 1 user, your current version 1.x software licence key (serial number) **will not be able** to enable the functionality of Brainsight 2. Rogue Research has adopted a new serial number scheme for Brainsight 2 and if you have not received a new serial number, please contact us ([support@rogue-research.com](mailto:support@rogue-research.com)) to

obtain a new number.

Note: If you are using a beta version and it expires (all beta versions have an expiry date to ensure that you update the software, either with a newer beta, or ultimately with the release version), you will still be able to load projects and view your data and perform 3D reconstructions, but you will not be able to calibrate tools or perform surgical sessions. At that point, you will need to obtain a more recent release of Brainsight using your serial number.

# Chapter 2: Overview of Robot-assisted Surgery

Robot-assisted micro-surgery uses advanced technology including stereo vision, imaging and navigation software, precision machining and accurate robotics to accomplish the goal of accurate placement of your tools in the surgical space. This chapter will introduce you to the major components and how they work to accomplish your task. More detailed explanations and procedures on how to perform these tasks will be presented in subsequent chapters.

## **INTRODUCTION**

The general purpose of the robot is to be able to hold and manipulate tools in the surgical space and to be able to do so with very high accuracy. Typically, we wish to guide the tools from outside the head to specific locations within the head (e.g. injection needle) along a specific path. Since we do not possess x-ray vision, we need a way to define these targets and paths to the target and give the robot the ability to know its location with respect to these targets in order to reach them. The way we accomplish this is to use a navigation system based on MR or CT images of your subject.

## **NEURONAVIGATION PRIMER**

The general principles of neuronavigation (often referred to as frameless stereotaxy or Image-guided surgery) are that a series of local coordinate systems are defined, and the navigator manages the calculation of transformations from one coordinate system to another (see Fig. 2-1). The anatomical images of the subject's head define a coordinate space onto which other data (e.g. functional scans, atlases) can be overlaid. The robot defines a coordinate space for itself (i.e., the real world, or subject's coordinate space) as well as coordinate spaces to describe the robot's tool holder (fixed tool assembly) and the coordinate system for the tool tip and orientation. The chain of transformations goes from the tool tip to the fixed tool assembly (called the tool calibration), from the fixed tool assembly to the robot base (provided by the

Fig. 2-1

Main components of the surgical system.

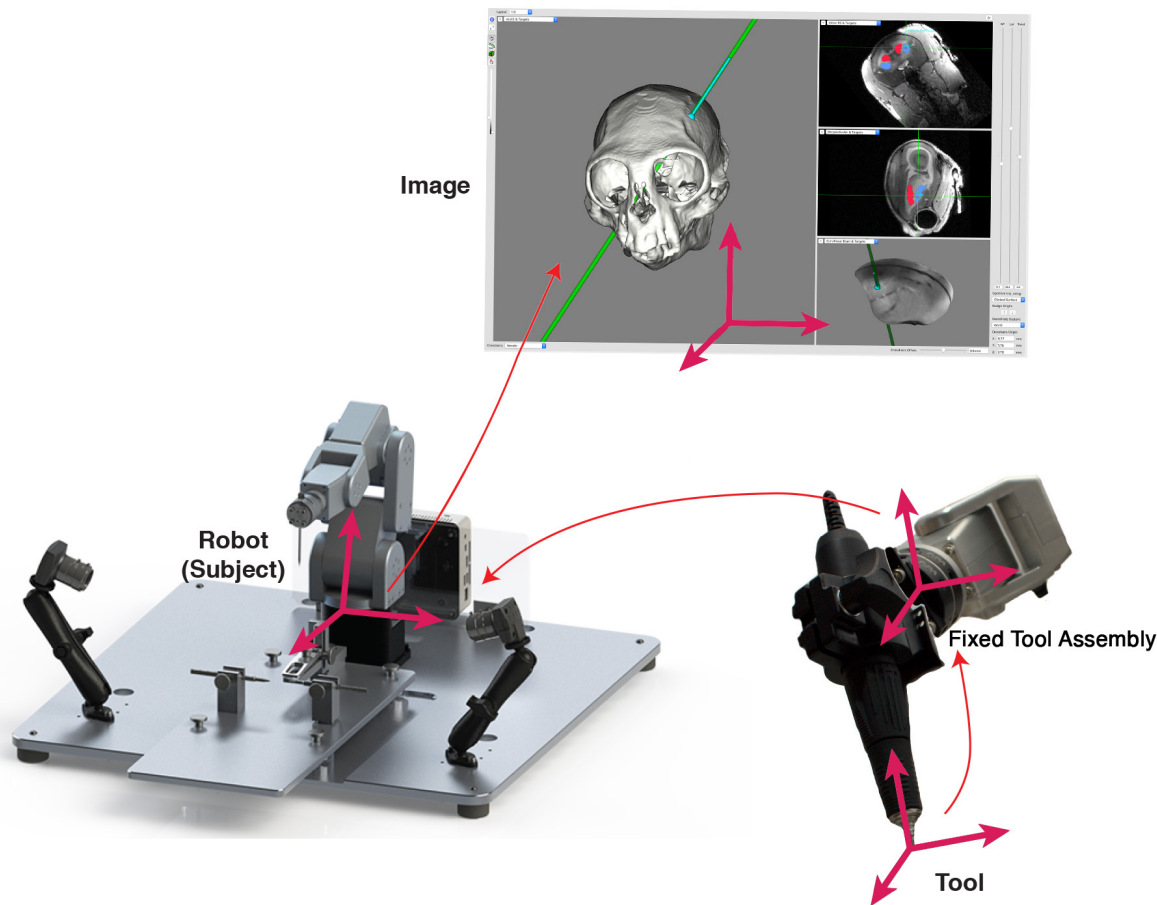

robot) and finally from the robot to the images (provided by performing the subject-image registration).

Both the tool calibration and the subject-image registration requires the ability to determine the position of landmarks in the subject coordinate space. This is accomplished using stereo video cameras that are carefully placed and calibrated such that identifying a point in the camera view yields the 3D coordinate in the subject space. This can be used for example, to identify the tip of a tool attached to the robot, or using a laser pointer, features on the subject's skull.

#### TYPICAL STEPS FOR IMAGE-GUIDED SURGERY

The overall layout of Brainsight is designed to follow the typical steps involved in preparing and ultimately performing a surgical procedure. Typically, some steps are specific to calibrating the tools used by the robot and calibrating the stereo imaging cameras (hardware specific tasks) or performing tasks in processing the image data for a surgery (subject-specific tasks).

#### Calibrate the cameras

The stereo cameras are used to provide the 3D coordinates of objects (or points) in the 3D world. In order to do this, a calibration must be performed to calculate the mapping from the 3D real world (as seen by the camera) to the 2D image taken by the camera. Using this calibration, any point in the camera's image can map back to a vector (line in 3D space) where any point along that vector would have cast that "shadow" on the image.

Fig. 2-2

Illustration describing the use of stereo cameras to identify the location of a point in the real-world (subject space).

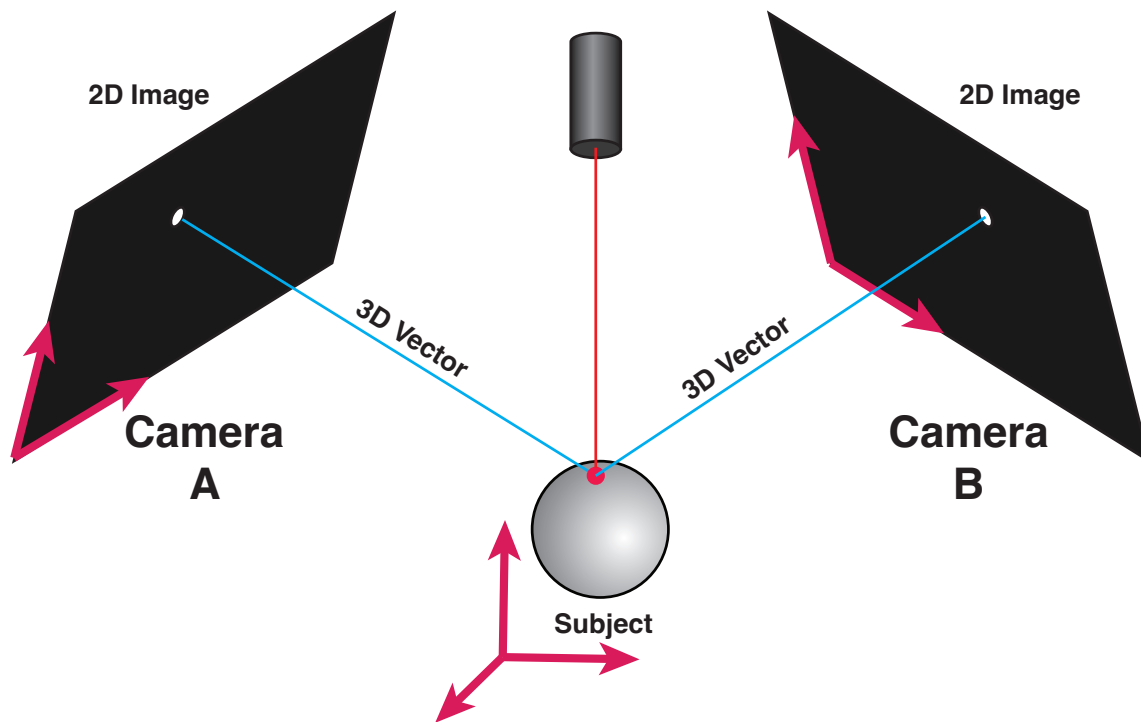

If two cameras are looking at the same region from two vantage points, then the two 3D vectors (one from each camera) will intersect at that unique location of the point. The camera system uses high resolution cameras and a careful calibration to perform this task with submillimeter accuracy.

The calibration procedure involves placing a target with a series of points at known locations in the real space and identifying these points on the images from the camera.

#### Calibrate your tracked surgical tool

The surgical robot can be told to move its arm to many positions and orientations. We do this by specifying the desired position and orientation of its "hand", being the fixed tool assembly (Fig. 2-3), onto which surgical tools are attached. Since we are more interested in placing the surgical tool to a given position and orientation (from a user perspective, we don't care about the fixed tool assembly, but rather the tool attached to it) the 3D relationship between the tool and the fixed tool assembly is needed (we call this the tool calibration). Using the stereo camera, the tip of the tool is identified as well as the orientation of the primary shaft, and stored in the system as a tool calibration.

#### Scan the subject

The starting point for subject-specific surgical preparation is the 3D image scan of the animal. If you are using a scanner intended for human use, keep in mind that often the animal is not in an orientation that is "understood" by the scanner (e.g. sphinx position), so keep a note of

Fig. 2-3

Attaching and calibrating a tool on the robot.

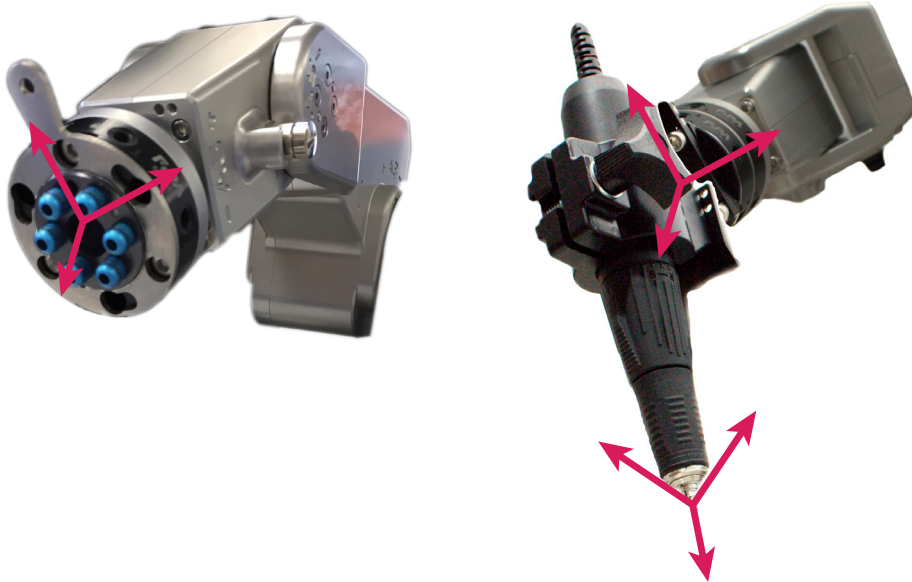

the actual animal position and what was entered in the scanner console for use later. This information will allow Brainsight to reliably figure out the scan's true orientation with respect to the animal's anatomy (e.g. right, left, anterior, superior).

#### Select the anatomical data set

This is the first step in processing the data needed to carry out a surgery on a specific animal. You will select the anatomical image file(s). Currently, we support DICOM (and ACR-NEMA), MINC (both MINC1 & MINC2), Analyze 7.5, NIfTI-1, PAR/REC and BrainVoyager™ anatomical (.vmr).

#### Co-register to the MNI coordinate space or other anatomical dataset

This step is optional and only applicable when the appropriate atlas exists for your animal type. If you wish to use MNI or Paxinos coordinates as a source of target(s), then you need to co-register the individual subject's MRI to the MNI coordinate space. You can do this by loading the matrix from MINC tools, or you can perform the registration manually in Brainsight.

Once the registration is performed, the images will not change but rather transformation between the native MRI and MNI space (and by extension, Paxinos space) is calculated and kept in memory allowing the coordinates of the cursor to be expressed in native or MNI coordinates.

Please note that Brainsight Vet Robot software currently



supports co-registration to MNI (Frey et al., 2011), Paxinos (Paxinos et al., 2009) and Saleem D99 (Reveley et al., 2017; <https://afni.nimh.nih.gov/pub/dist/atlas/macaque/README.txt>) coordinates in the macaque monkey. Other species atlas data sets are supported in the software, such as the Fraunhofer sheep atlas (Nitzsche et al., 2015) as well as a marmoset atlas (Paxinos et al., 2012).

### Select one or more overlay data sets

This step is optional. If you are using functional data as a guide for targeting, or you have multiple types of anatomical scans that you wish to visualize (e.g. T2, Flair...) you can load them in Brainsight and display them on both the 2D slices as well as the curvilinear reconstruction (described below).

### Create a Region of Interest using the Region Paint Tool

This step is needed if you wish to generate 3D images of the brain, skull (essential for the registration) or any sub-structure within the brain. Use this painting tool to highlight a particular region (e.g. brain or motor cortex) in the anatomical (or any overlay) data. The region of interest will be visible in any of the 2D views, and can be used as the boundaries to generate a 3D representation of it as well (see "Perform 3D reconstruction(s)").

### Perform 3D reconstruction(s)

One of the most important features in modern image display software is the ability to display 3D representa-

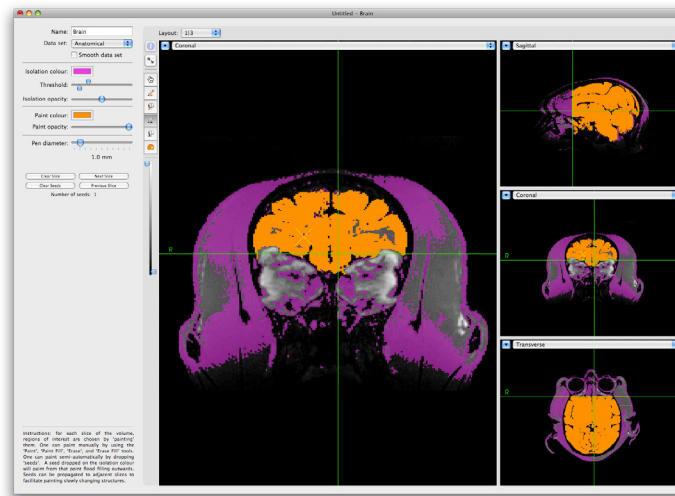

Fig. 2-4  
Example of ROI tool in use.

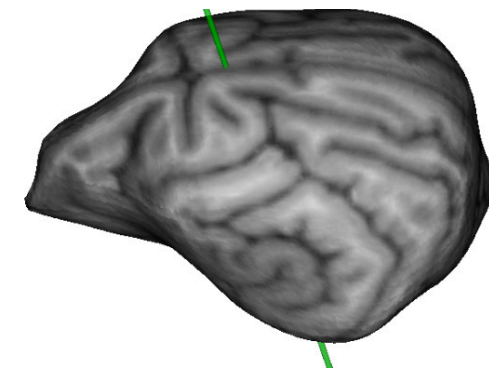
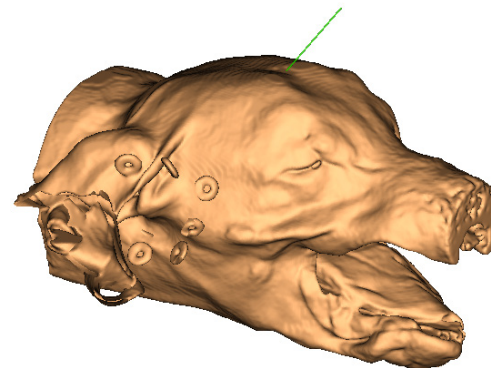

Fig. 2-5

A: Example of a skin surface registration.

B: Curvilinear reconstruction of the brain.

tions of your data. This is especially useful in neuro-navigation where you are required to use the image display to position a tool in 3D over the subject's head and to match the shape of the skull during the subject-image registration procedure. Brainsight currently supports two types of reconstruction: surfaces based on voxel labelling (either automatically using intensity thresholding or manual region painting), and curvilinear reconstruction.

The first is often referred to as a segmented surface mesh, or isosurface, where a surface (e.g. skin, skull) is represented as a series of triangles generated by segmenting the raw MRI voxels (see Fig. 2-4A for an example of a segmented skin surface) based on a voxel intensity threshold.

The second reconstruction technique is called curvilinear reconstruction (see Fig. 2-4B). This technique was originally developed for (human) visualization of a class of lesions involved in epilepsy called focal cortical dysplasia (see Bastos et al., *Annals of Neurology*, July 1999). The technique also provides a unique method of viewing the brain anatomy within the region of the cortical ribbon that often encompasses the surgical target.

In short, a smooth surface representing the outer shape of the brain is generated along with a series of concentric surfaces (like the layers of an onion), and those surfaces are painted with the intensity values of the voxels that intersect that surface. By interactively peeling these

surfaces, an excellent appreciation of the anatomy within the cortical ribbon can be obtained.

Please note that for best curvilinear reconstructions in animals, you should first paint all slices of the brain and select "Curvilinear from ROI" in the dropdown menu. The option "Full Brain Curvilinear" uses a human head template in its matrix and tends to wrap the edges of the animal's head into the reconstruction.

#### Select landmarks for registration

The starting point for the subject-image registration is two anatomical landmarks. The image version of the landmarks are identified in advance, typically by clicking on the landmark on the 3D reconstruction (skull) and recording the landmark.

#### Select your target(s)

Targets can be chosen using a variety of methods. The most straightforward is to visualize the target anatomically on the image display and record the location. If an MNI registration was performed, then MNI or Paxinos coordinates can be used. Finally, if functional data is superimposed, then functional peaks can be used by clicking on the peaks and dropping a marker.

Targets can be recorded as a simple point (x, y, z), a trajectory (which is a point along with an orientation), or a grid for electrophysiology experiments.

#### Perform surgery

Once all the "homework" has been done, a surgical

session can be performed. The session itself is performed as a sequence of steps. As with the main window, the steps for a session are laid out as a sequence of buttons along the top of the window.

- 1. Prepare the suite and robot.** Before starting the surgery, you need to set up your equipment. Much of the setup is dependent on the type of surgical procedure. In the context of the neuronavigation equipment, the set-up involves planning what needs to get sterilized, making sure the robot is prepared and all the tools are calibrated.
- 2. Connect the equipment.** The computer needs to be moved to the surgical suite and connected to power and to the robot.
- 3. Fix the subject's head in the stereotaxic frame.** Once the apparatus is set, you are ready to begin the experiment. Fix the head into the stereotaxic frame (supplied by Rogue Research).
- 4. Begin the surgical procedure** by resecting the skin over the skull. Keep in mind that the resection should be as wide as possible to expose the skull for the co-registration procedure with the laser.
- 5. Perform the subject-image registration.** Under the direction of the software, draw the region that covers the exposed skull in the camera view to identify the surgical field. Fix the Laser pointer to the robot fixed tool assembly and direct the robot to point to the two landmarks on the skull. After

identifying the points, the robot will automatically scan the skull surface with the laser and acquire a set of points on the skull used to refine the registration.

- 6. Perform the surgery.** Now, using the robot, perform the surgery. This may include drilling small holes and inserting needles, or similar tasks.

#### **Review the acquired data**

After the surgery session, you may want to review the data acquired. For example, you may wish to visualize the recorded location of an injection needle, or examine the resulting needle tracks for a grid based on the recorded location of an implant.

#### **Atlas references**

Frey, S., Pandya, D. N., Chakravarty, M. M., Bailey, L., Petrides, M., & Collins, D. L. (2011). An MRI based average macaque monkey stereotaxic atlas and space (MNI monkey space). *Neuroimage*, 55(4), 1435-1442.

Nitzsche, B., Frey, S., Collins, L. D., Seeger, J., Lobsien, D., Dreyer, A., ... & Boltze, J. (2015). A stereotaxic, population-averaged T1w ovine brain atlas including cerebral morphology and tissue volumes. *Frontiers in neuroanatomy*, 9, 69.

Paxinos, G., Huang, X., Petrides, M., & Toga, A. (2009). *The rhesus monkey brain in stereotaxic coordinates*. 2 ed. San Diego, California, USA: Academic Press.

Paxinos, G., Watson, C., Petrides, M., Rosa, M., & Tokuno,

H. (2012). *The marmoset brain in stereotaxic coordinates*. Elsevier Academic Press.

Reveley, C., Gruslys, A., Ye, F. Q., Glen, D., Samaha, J., E. Russ, B., ... & Saleem, K. S. (2017). Three-dimensional digital template atlas of the macaque brain. *Cerebral cortex*, 27(9), 4463-4477.



# Chapter 3: Setting Up the Brainsight Robot

The Brainsight robot system consists of several components that act together to see the surgical space, co-register that space to pre-operative images of the surgical subject and to manipulate tools to carry out the surgery. This chapter will cover setting up each component and ensuring that everything is configured correctly for use in planning and executing surgical procedures.

## **SYSTEM OVERVIEW**

The Brainsight micro-surgical robot includes multiple components (see Fig. 3-1 and Fig. 3-11). Some of these require special care when setting up to ensure that they work accurately and safely.

### **Brainsight navigation computer**

The navigation computer is your main point of interaction with the surgical robot. The Brainsight navigation software provides all the functionality to calibrate and control the robot and stereo-imaging system, load and process images of your subject (or atlas images), plan the surgery by defining targets for your drill and other tools, as well as control the robot itself to carry out the surgery.

### **Robot controller module**

The robot controller contains a computer that acts as the interface between the Brainsight navigator and the stereo-imaging cameras and robot. It also contains the power supply for the robot.

### **Aluminum base plate**

Consists of a large, precision machined plate with template holes and slots onto which the robot, stereo cameras and cassettes are attached. Note the base plate is different for larger animal surgical procedures (see Fig. 3-1 and Fig. 3-17).

### **Robot**

The robot is a one piece unit with six joints, integrated controller base and connectors.

Fig. 3-1

Overview of the surgical robot system with optional base plate and stereotaxic bars for larger animals (insert).

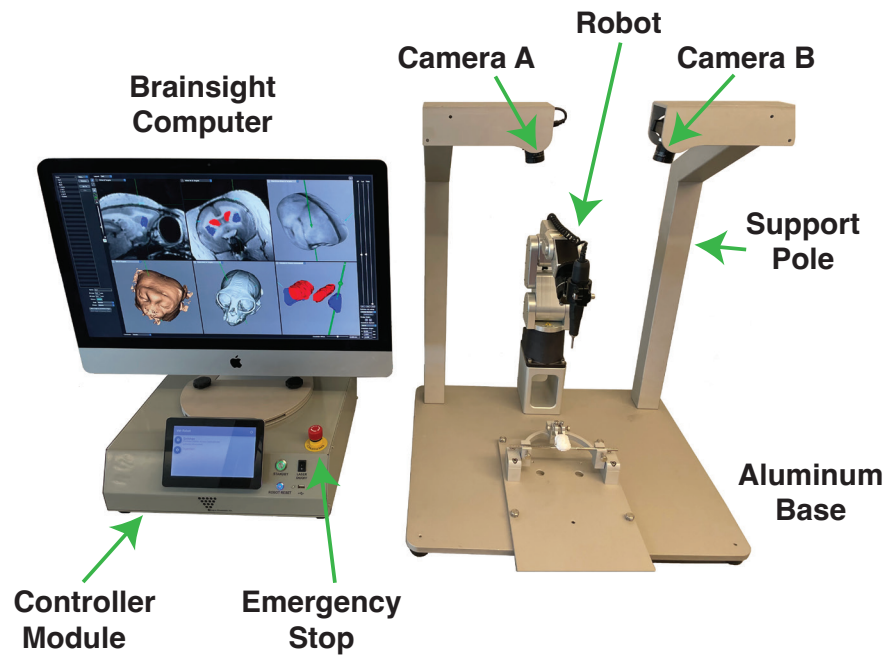
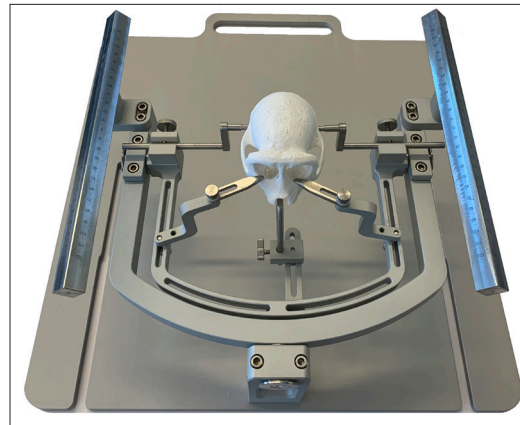

### Stereo-imaging cameras

Each camera consists of the camera body, a mounting bracket and support pole. Prior to calibrating the robot and stereo cameras it is important to focus each camera lens using the supplied paper template (see Fig. 3-2). The template should be kept at the height of the animal's skull when focusing. When using the 16mm lenses (large animal), the aperture should be set to 16, whereas in the 50mm lenses (small animal), it should be set to 22. The Exposure and Gain for the cameras should be reduced as much as possible, yet light enough in order to see the dot pattern.

### Stereotaxic frame for head fixation

A removable plate with a stereotaxic head holder. Different stereotaxic apparatuses are available for different animals.

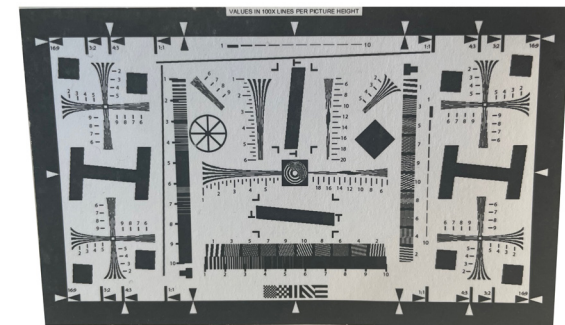

Fig. 3-2

Camera lens calibration pattern.



Fig. 3-3

Close-up of the stereo camera and tilt adjustment.

### ASSEMBLING THE ROBOT

Remove all parts from the packaging and inspect them for damage.

1. Put the base plate on a sturdy, level table.
2. Locate the two camera posts and the screws that will secure them to the base plate. Screw the posts to the base plate with the screws and tighten the bolts using the appropriate hex tool.

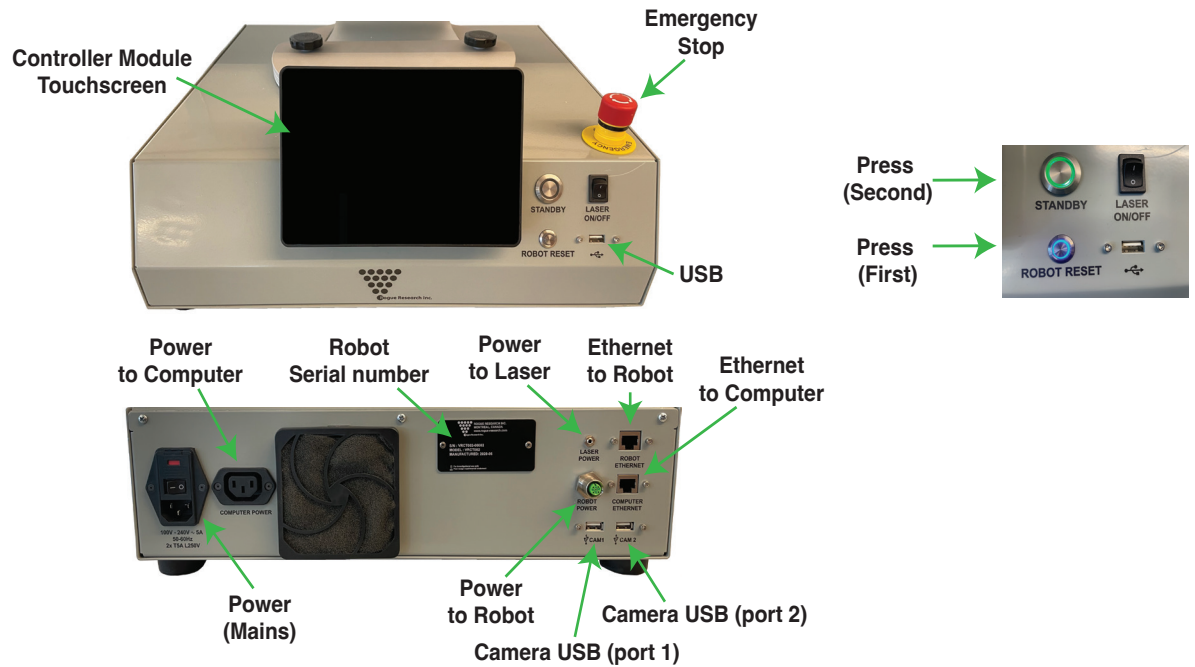

Fig. 3-4

Controller module: Front (top) shows the power button, USB port (for firmware updates) and the emergency stop button connector. Rear (bottom) shows the main power connector and switch, the Ethernet connectors for the Mac and robot as well as the Ethernet connectors for the two cameras.

Fig. 3-5

Connector panel of the robot: Upper connector is the power cable while the lower connector is the Ethernet cable.



3. Place the cameras on the end of the poles. Use the angle adjustment knobs (see Fig. 3-3) to position the cameras in the approximate location, but the final adjustment will be set during the camera calibration step.
4. Place the robot on the plate and align the mounting holes with the slots on the plate. Using 4 hex bolts, secure the robot base to the base plate. Note the base plate for larger animal surgical procedures (see Fig. 3-1).
5. Place the controller module near the robot (see Fig. 3-1, Fig. 3-5 for details of the connectors).
6. Connect the supplied Ethernet cable between the controller module and robot. Note the connector at the controller module is a standard USB-A while at the robot end it is a round connector that requires that you screw on the connector (see Fig. 3-5).
7. Connect the 2 USB cables between the cameras and the controller module.
8. Plug the robot power cable (that comes out of the rear of the controller module) into the upper connector of the robot panel (see Fig. 3-5).
9. Set the Brainsight computer near the robot. Connect the Ethernet cable between the robot and the Brainsight computer.
10. Plug the power cable for the controller module to the appropriate mains power. Do the same for the

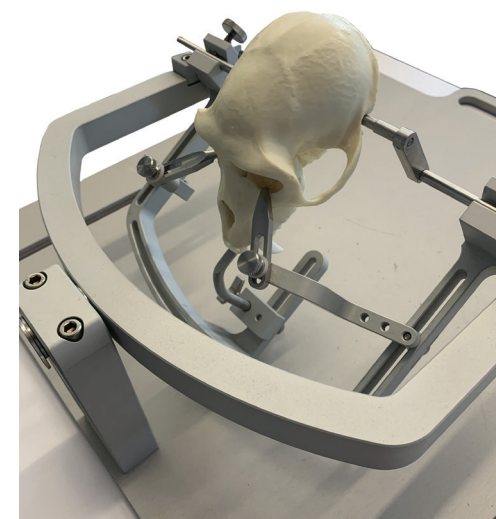
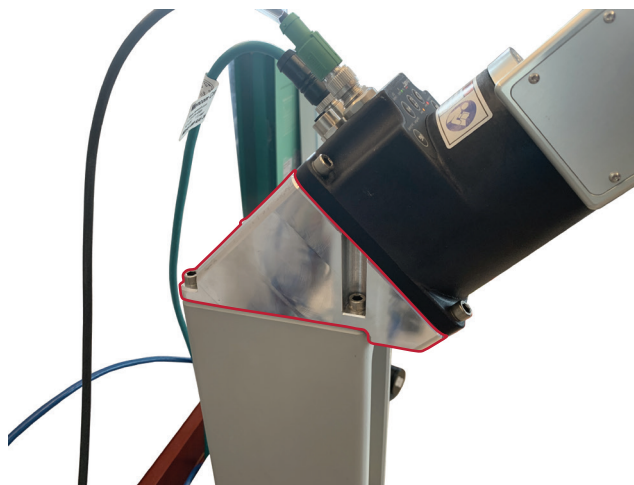

Fig. 3-6

**45° adaptor plate for caudal visual and cerebellar targets.**

Brainsight computer.

11. Use the levels provided to level the robot table.

**SETTING UP THE STEREOTAXIC APPARATUS**

In some cases, targeting may involve the cerebellum or caudal visual cortical areas. Due to the limitations of the robotic joints, it may be necessary to pivot the animal's head anteriorly in the adjustable frame as well as adding a 45° adaptor plate below the robot arm (see Fig. 3-6).

This allows for easy access to the base of the head and ensures that the robotic arm can reach more posterior targets.

It should be noted that that the 45° adaptor plate needs to be in position prior to carrying out the calibration of the cameras that is mentioned in the next section ("Calibrating the Cameras"). If the adaptor plate is removed, the calibration of the cameras will need to be carried out once more.

When the 45° adaptor plate is being used and the



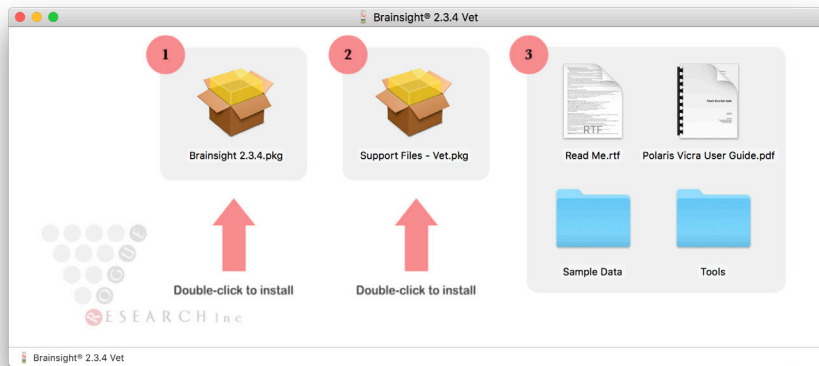

Fig. 3-7

### Brainsight Disk Image.

animal is tilted forward, the registration of the animal to their scan with the Laser will be performed in this tilted position (see Fig. 3-6).

### SETTING UP THE NAVIGATION COMPUTER

Your Brainsight computer should have come with the software pre-installed. If so, skip to the next section ("Calibrating the Cameras"). Otherwise, turn on your iMac computer and follow these instructions:

If you have an up to date Brainsight USB key, insert it into a USB port. Otherwise, follow the instructions on the download page at [www.rogue-research.com](http://www.rogue-research.com) to download the disk image.

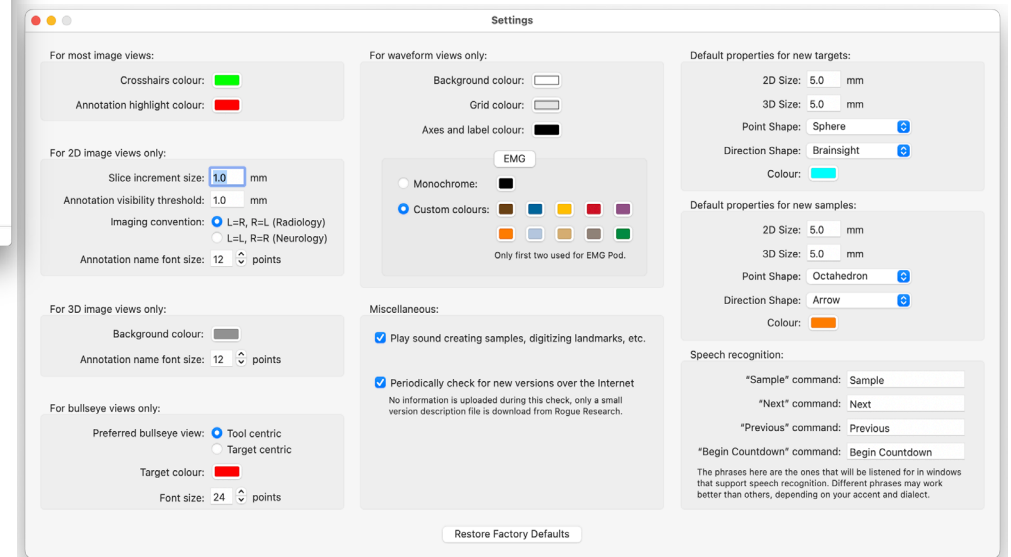

Fig. 3-8

### Preferences Pane.

### Installing the software

Brainsight uses an installer to install the software as well as the drivers and support files needed. Double-click on the disk image to mount it on your desktop.

1. Double-click on the installer package to initiate the install process (see Fig. 3-7).

2. Click on **Continue** to get to the terms of use page. If you agree to the terms, then click **Continue** a second time. In the next screen, simply click **Install** and all the required components will be installed.
3. Once you click the **Install** button, you will be requested to enter the name and password of a user

with administrative privileges. Enter it to continue the install.

- Once the install is complete, the final screen will appear confirming success. Click on the **Close** button to complete the install.

### QuickLook Plugin

One of the software components installed is a QuickLook™ plugin. This adds the ability to display preview thumbnail images rather than a generic icon. The plugin supports many of the image data formats supported by Brainsight including (but not limited to) DICOM, MINC, NIfTI and Analyze. Note that if you use other software on your computer that installs its own QuickLook™ plugin for the same formats, either one may be called upon by the operating system.

### Firmware updates

Below are the instructions to perform a firmware update:

- Download the firmware update file from the download page of the website: <https://www.rogue-research.com/downloads>.
- Use the Vet Robot controller serial number (e.g., VRCTXXXXXX-XXXX).
- Copy the downloaded file on a USB key.
- Turn on the controller (press the standby button in front).
- Connect the USB key into the front port at the front of the controller (see Fig. 3-9).

- Using the touchscreen, go to the **Settings** page, and select **Firmware Update**. You should be prompted with a list of available update files on the USB key. Select the downloaded files and press **OK**. The update should take a few minutes and the controller should turn off upon completion.

Important Note:

- If updating from 2.3.x, first update to 2.4.x and only then update to 2.5.x. There is no direct update from 2.3.x to 2.5.x.
- If updating from 2.3.x or 2.4.x to 2.5.x, the network interface cables need to be swapped at the back of the controller before turning it on again. The robot green ethernet cable should be connected into the Computer Ethernet port, and the white ethernet cable should be connected into the Robot Ethernet port (see Fig. 3-10). This change addressed a performance issue which would in rare occasion cause dropped camera frames, or image corruption.
- Note that if your Vet Robot was shipped with firmware 2.8.x or higher, there is no need to switch the ethernet cables as we have changed everything internally.

### Setting your preferences

When you first install Brainsight, it should work “right out of the box”. There are many options that allow you

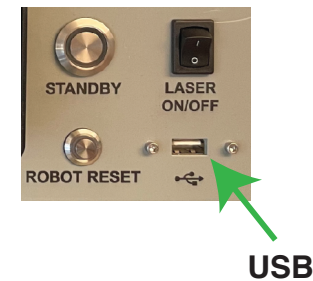

Fig. 3-9

USB port at the front of the controller.

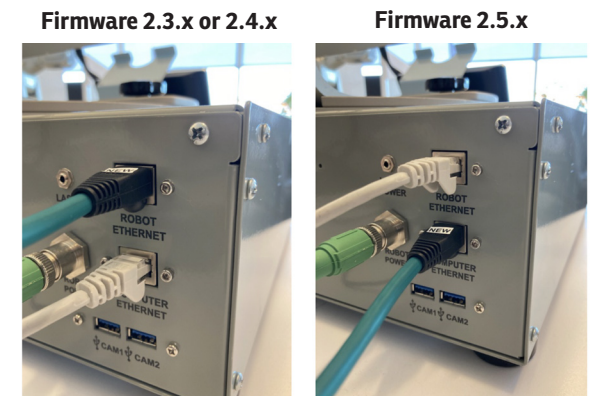
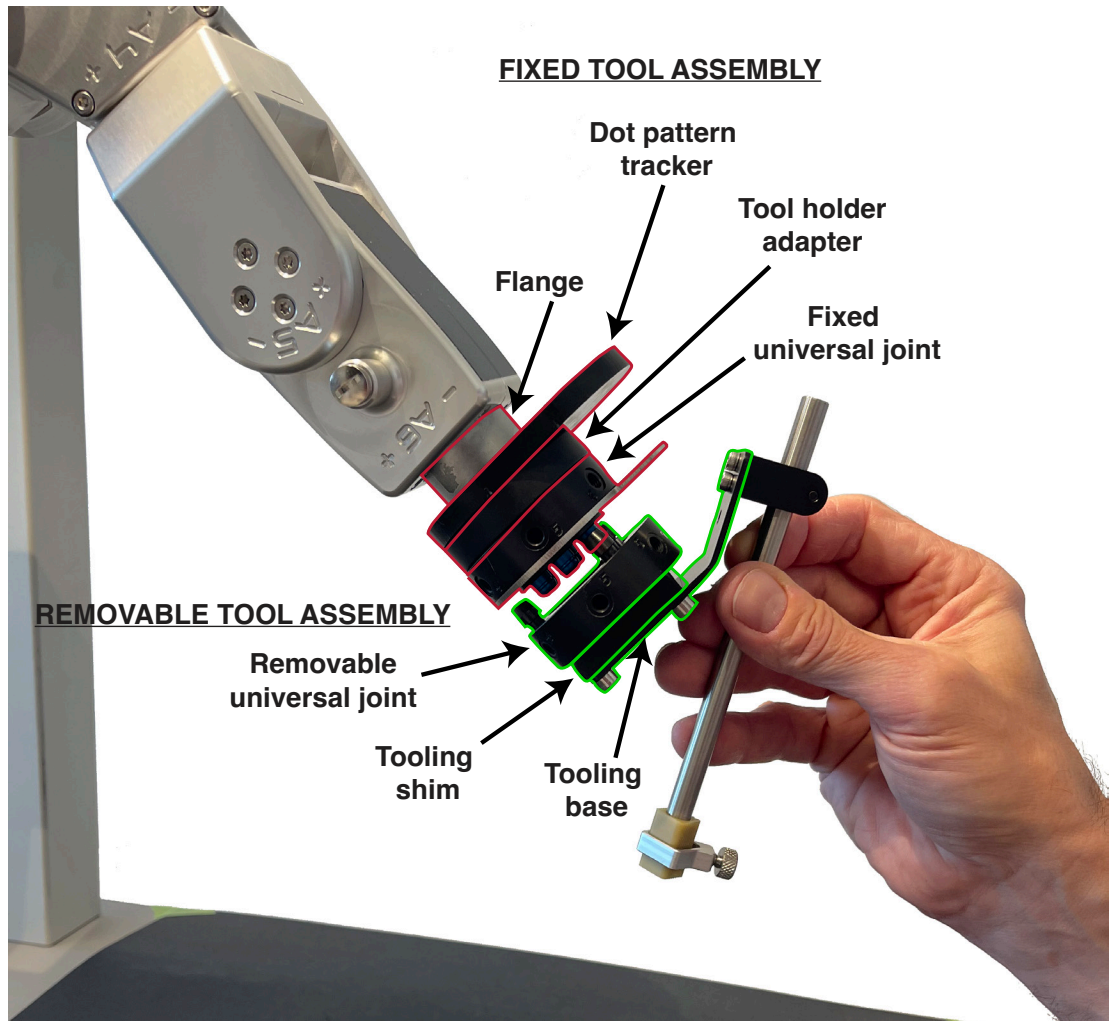

Fig. 3-10

Firmware update from 2.3.x, 2.4.x to 2.5.x.



to customize certain aspects of the software. This section will describe these options. Some of these options require an understanding of the software's functionality that is described later in the manual. It is a good idea to read through this as a list first with the understanding that many of these options will become clearer once you have familiarized yourself with the different aspects of Brainsight.

Note that to change Appearance of windows (Light/Dark), go to **Apple menu->System Settings** on your Mac.

Launch Brainsight, and select **Brainsight->Preferences** (see Fig. 3-8).

**Crosshairs colour:** Refers to the colour of the crosshairs that indicate the location of the cursor. Click on the **Colour** to open the colour picker to pick a colour.

**3D Background colour:** When Brainsight renders a 3D scene, the surrounding space (background) requires a colour. Change it by clicking on the **Colour** to open a colour picker to choose your colour.

**Slice increment size:** When viewing a 2D plane it is possible to go from one slice to the other using the arrow keys or the mouse's scroll wheel. Each keypress of the arrow or movement of the scroll wheel will move the cursor the distance set by this preference. Change it by typing a new number in the box.

Fig. 3-11  
Robot fixed and removable tool assemblies.

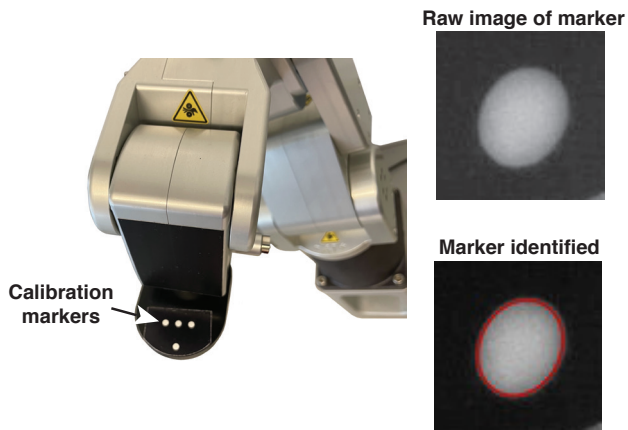

Fig. 3-12

Calibration markers on the dot pattern tracker of the robot and the resulting image.

**2D View annotation visibility threshold:** When a marker location intersects a 2D imaging plane, the annotation is drawn on the plane. The threshold value determines how close to the plane the marker needs to be considered on the plane.

**Imaging convention:** When viewing 2D transverse and coronal slices, there is an ambiguity regarding which side of the image is the subject's left or right (this ambiguity dates back to when X-rays were viewed as translucent films placed on a light box). There are two conventions, often referred to as Radiology and Neurology for

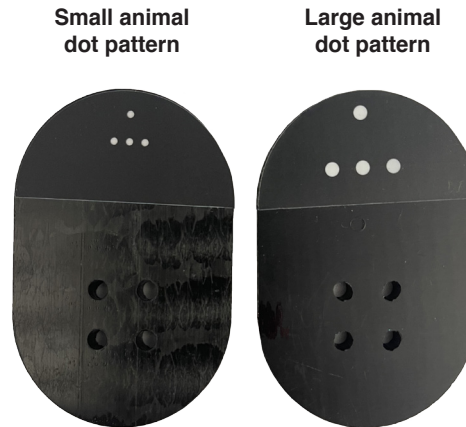

Fig. 3-13

Dot patterns for small and large animal.

historical reasons. Radiology is the convention where the subject's right is displayed on the left of the screen and vice-versa. Neurology refers to the convention of the subject's right being on the right of the screen (think of it as looking at the subject's face, or the subject's back, or looking with the subject). Brainsight always displays an R symbol for the subject's right side (on the left when in Radiology convention, and on the right when in Neurology convention), so you will always know which convention you are using.

**Default properties for new targets:** In Chapter 12, you will

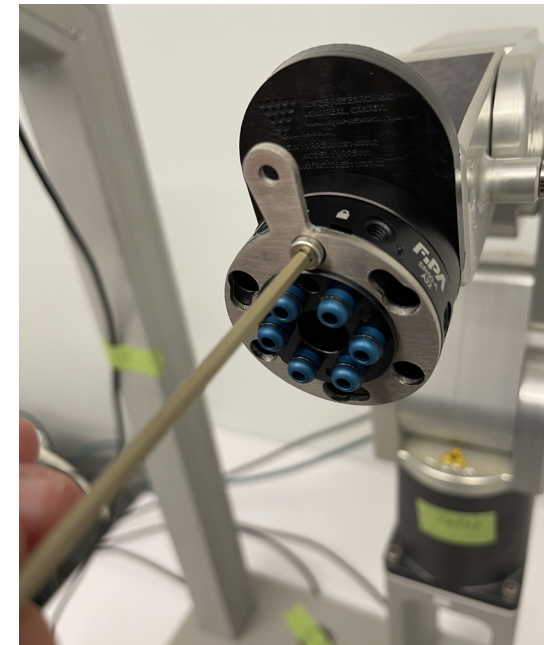

Fig. 3-14

Removing the screws from the fixed universal joint.

define targets of interest (e.g. injection site, or recording target), and how they are to appear on the screen. When a new target is created, some default values are needed, and they are defined here. The **2D size** represents the size of the glyph when drawn on 2D planes (e.g. transverse), while the **3D size** determines the size when drawn in a



Fig. 3-15

Replacing existing pattern on the dot pattern tracker.



3D view (they are different because the nature of the displays often require different values for effective display). **The point shape** describes the shape of the glyph that indicates the location of the target. The **Direction shape** determines the shape of the glyph that indicates orientation (when the target is a trajectory, rather than a simple marker). The **colour** is the colour to use when drawing the glyphs when the marker is not highlighted. Highlighted markers are always drawn in red to differentiate them from the others.

**Targets** are points that are set prior to a surgical or recording session. **Samples** are recordings of the location and orientation of a tool during a surgical or recording session. The default values for their appearance can be set here. The attributes are the same as for targets, so refer to the target preferences for a description of the individual attributes.

**Periodically check for new versions of Brainsight over the internet:** Refers to a function that communicates with our server each time it is launched to see if there are any updates available. If your computer is connected to the internet, enable this feature to ensure you are informed when an update is available.

### CALIBRATING THE CAMERAS

One of the most important parts of your Brainsight robot are the stereo cameras used to link the real world to the image world. They do so using a calibration that

determines the projection matrix from the 3D space in the camera's field of view to the pixels of the image it acquires. When the cameras are set up, or their positions are changed in any way, they need to be calibrated.

The calibration procedure uses the robot to place visual targets at many locations within the camera's field of view. We use machine vision techniques to automatically identify the location of the markers in the images (see Fig. 3-12). The robot will move in a grid-like pattern in the cameras' field of view while the cameras acquire points. Each camera point is matched with the known location of the calibration marker on the robot (the robot defines the real-world 3D space). This provides a list of homologous point pairs (points of the same thing in both the real space and the image space) that can be used by the software to calculate this projection matrix.

For Brainsight Vet Robot users who have the same robotic arm for both large animals, such as macaque, and other species (marmoset and rodent), you will need to change the calibrated dot pattern that Rogue Research supplies. These steps should be completed prior to carrying out a Vet Robot Calibration. The large dot pattern is used for large animal with the 16mm camera lenses, and the small dot pattern for smaller animals such as marmoset, rat and mouse (50mm camera lenses). Please note that if the dot pattern is dirty or scratched, contact support@rogue-research.com for replacements.

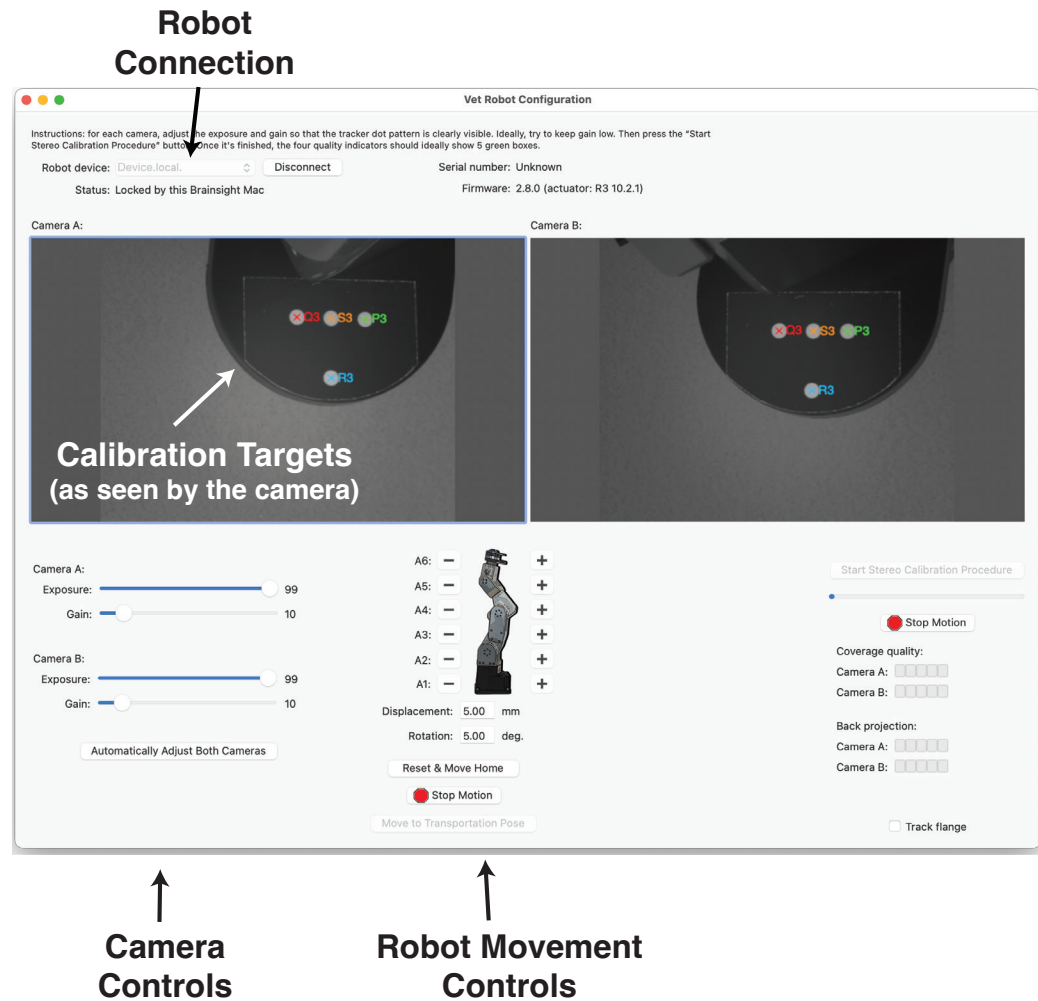

Fig. 3-16

Stereo Calibration Window.

Below is the procedure to follow:

1. Identify the dot pattern (see Fig. 3-13).
2. Remove the screws from the fixed universal joint (see Fig. 3-14).
3. Remove the existing dot pattern. Note that the dots must be facing the robot (see Fig. 3-15).
4. Add the proper dot pattern and replace the screws (finger tight).
5. Perform the Vet Robot Calibration.

### Setting your preferences

It is recommended that one warm up the stereo cameras prior to doing a Vet Robot calibration. This entails turning on the controller along with the Brainsight Vet software and connecting the robot in a Brainsight window. Once the cameras are turned on, leave them on for 30 minutes prior to performing a robot calibration.

1. Make sure that the Brainsight computer is on and Brainsight is running.
2. Make sure the cameras are connected to the control module and that the control module is turned on by using the main power switch on the rear panel, then press the front power button. The power button will turn green.
3. Select **Window->Vet Robot Configuration**. A window will open (see Fig. 3-16).
4. Select your robot in the robot selector popup button

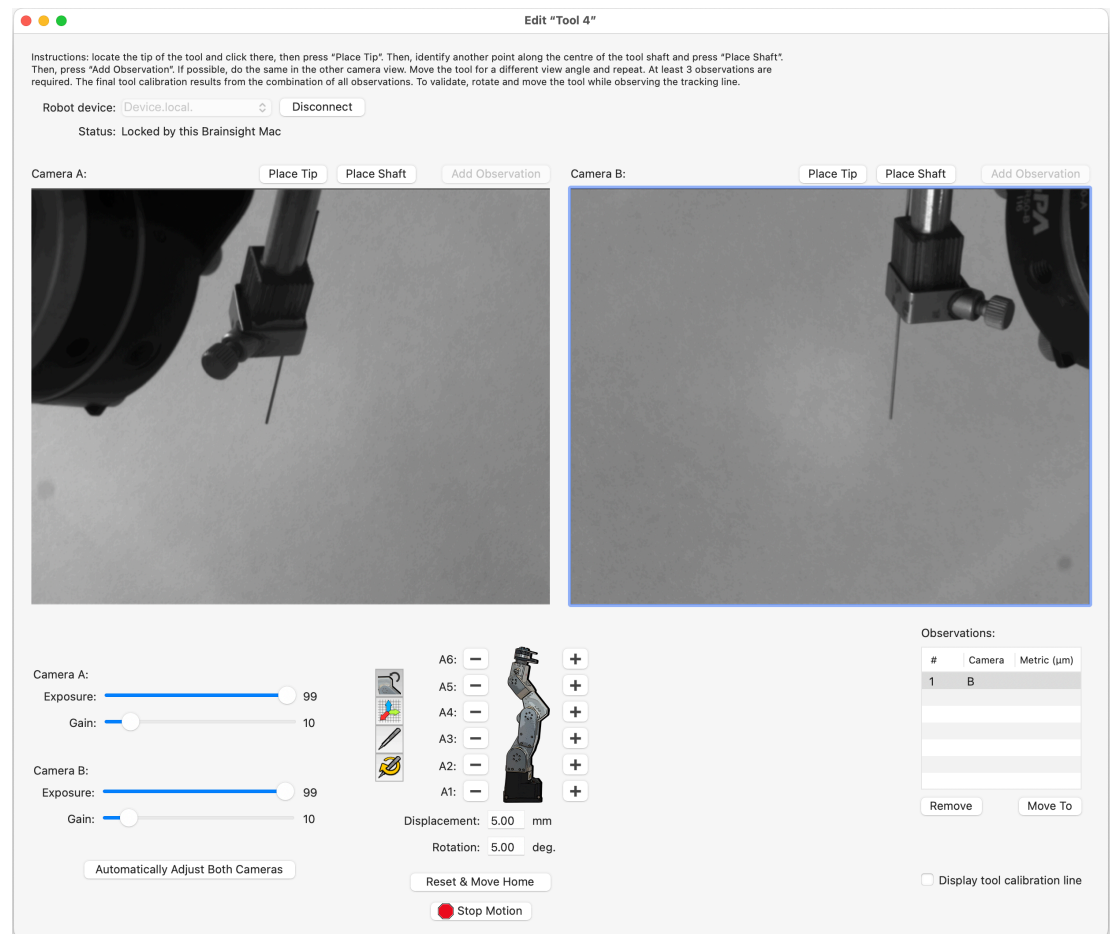

Fig. 3-17

Select your base plate and robot stand configuration.

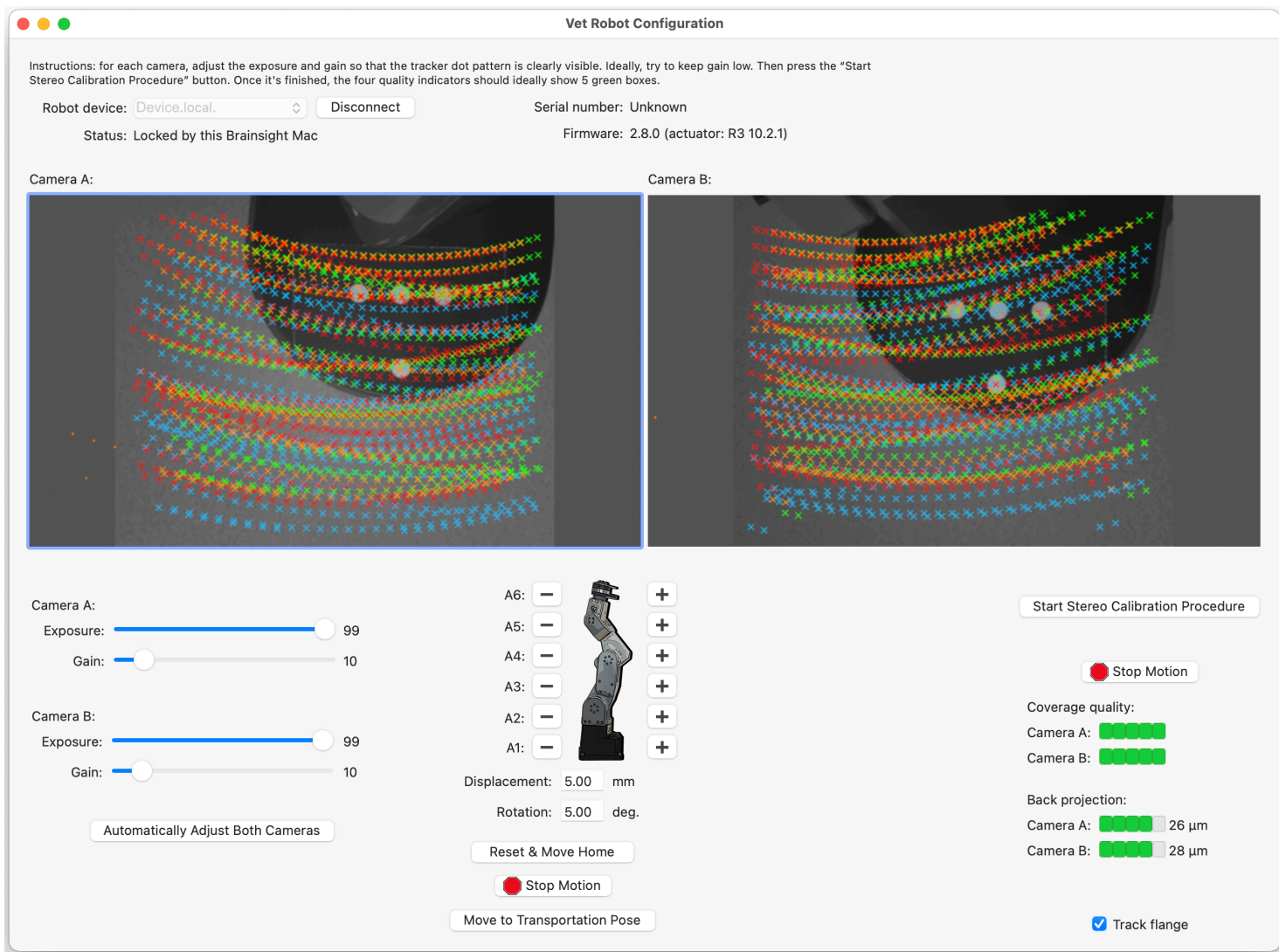
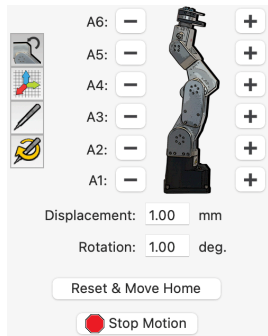

Fig. 3-18

Calibration screen with markers displayed.



### A Joint-based movements



### B



### Cartesian movements

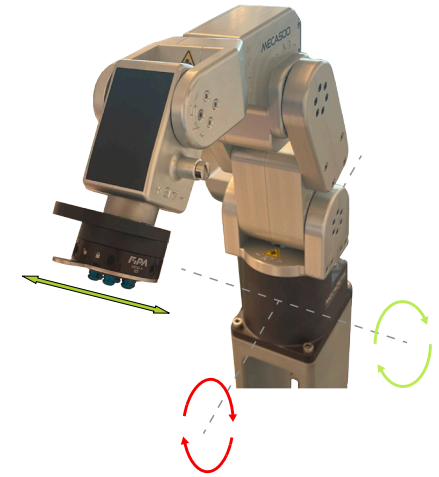
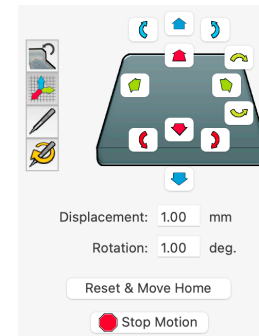

### C Simple tool-based movements

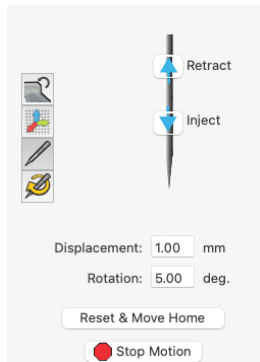

### D

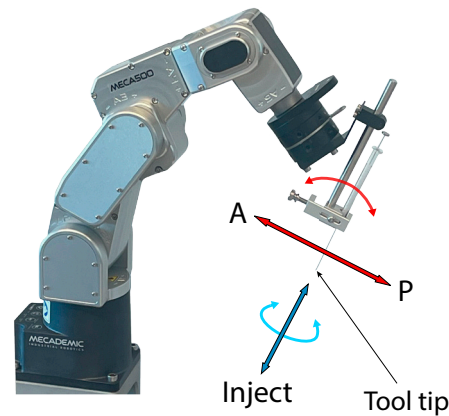

### Advanced tool-based movements

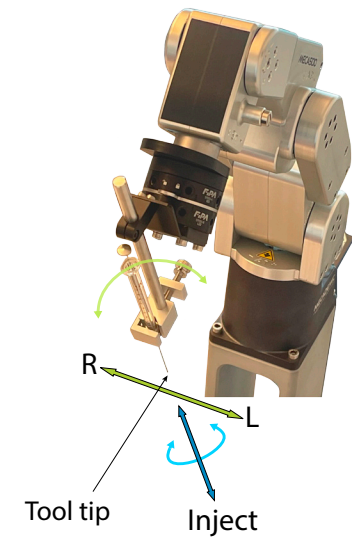
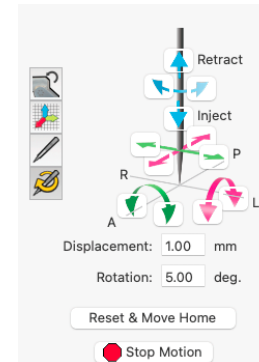

Fig. 3-19

Illustration of the tool movements for the robot. A) Controls for joint space movement of the robot. One can change the angle of any of the six joints in either the positive or negative direction. B) Controls for Cartesian space movement of the robot allowing linear movements in the up, down, front, back, left, and right directions, as well as rotations around the respective axes. C) Simplified controls for injection/retraction for surgery. D) Controls for tool space movement, allowing movement of the tool in A-P (anterior-posterior), R-L (right-left) and Inject-Retract directions, as well as rotations around the tool tip in all three axes.

(top left of the window). There should only be one entry (unless you have multiple Brainsight robots on your network called **vetrobot.local**). Press **Connect** to initiate the connection.

5. After a moment, the Brainsight computer should connect to the controller module and the images from both cameras will appear on the screen.
6. Make sure the lighting in the room is optimal for the cameras. The light should be diffuse (e.g. overhead ceiling lights) and avoid spot lights that create shadows or uneven illumination in the robot workspace.
7. The procedure will involve the robot moving about a wide range of locations. Remove any obstruction on the robot platform, as well as the stereotaxic frame. The software will prompt you to select the base plate you are currently using (see Fig. 3-17).
8. Using the camera controls, adjust the gain to ensure a good contrast between the black of the fixed tool assembly and the white of the markers. First, try clicking **Automatically Adjust Both Cameras**. Otherwise adjust the gain and offset controls.
9. Click **Automatic Stereo Calibration** to start the process. Note that when clicking the button, the robot will begin to move.
10. While the robot moves, registration points will be acquired and displayed on the screen (see Fig. 3-18).

Watch the screen to confirm that the points identified appear to be in the right location. At any time, the process may be stopped by clicking **Stop Motion** in the robot controls.

11. Once the robot has stopped moving, click **Calculate Stereo Calibration** to save the calibration. Note the **back projection error** field. The value should be less than 1.0. Otherwise, consider changing the lighting and repeating the process.

### TESTING THE ROBOT

Movement of the robot can be performed in two ways. First, using the manual controls within Brainsight (see Fig. 3-19) and second, by selecting a target in surgery and clicking **Move to target**. This section will cover the first method. Manual movement of the robot will be necessary when loading/removing tools and moving a new tool into the field of view of the stereo cameras for tool calibration.

It is important to understand that every motion of the robot is done from a specific perspective and is aligned to a specific coordinate system (recall Fig. 2-1). In general, all linear motion and rotations are carried out in the robot (subject) coordinate system, with the exception of the Inject-Retract controls. Fig. 3-19 illustrates each movement control and the actual vector of the movement.

### Moving the robot

1. Follow the steps of the previous section to turn on and connect to the robot with the Brainsight software.
2. Click **Reset & Move Home** to bring the robot to the home position.
3. Enter a number in the **Displacement:** field (or keep the default, 1mm). Keep this value reasonably small to keep the amount of movement reasonable for each click to avoid accidentally hitting anything in the field of view.
4. To acquaint yourself with the direction of the motion and understand the motion needed to bring the fixed tool assembly to any arbitrary position and orientation, press the buttons that switch between different movement types of the robot (illustrated in Fig. 3-19).
5. When finished, click **Reset & Move Home** to return the robot to the home position.
6. Make sure all tools are removed from the fixed tool assembly and close the window. This will automatically disconnect the robot.
7. To turn off the robot controller, push the green power button at the front, wait for the light to go out and then turn off the main power in the rear of the controller module.

## IMPORTANT

Before shutting down the robot, we advise you to click **Reset & Move Home** to return the robot to the home position. If it occurs that the robot was shut down without clicking **Reset & Move Home** button, the robot may find itself in an abnormal position.

Although rare, when joint 6 is rotated more than 420 degrees and powered off, before being homed, it can run into a positional error. The fixed tool assembly does not return to the twelve o'clock position.

Here is the solution. The procedure can be carried out in the Vet Robot Configuration window:

- Connect and click **Go Home**.
  - If the fixed tool assembly is not at twelve o'clock (which it is not at the moment), set the angle step to 30 degrees (bottom of the screen), and rotate J6 24x times. Wait until each joint movement is completed before clicking again.
  - Press the emergency stop on the controller (large red button).
  - Turn off the controller using the standby button (green button).
  - Reset the emergency stop (pull and twist upwards).
  - Turn on the controller using the standby button and press the reset robot controller button (blue button) and then home the robot.
- You may have to repeat these steps twice until the fixed tool assembly is at the correct position.

### Robot does not return to home position

If it happens that the robot is in an abnormal position and it does not respond to clicking on **Reset & Move Home** (i.e. it does not go to the home position), we can bring it home manually using the Zero Gravity procedure. Zero Gravity is a feature of the robot that temporarily allows it to be placed in a non-rigid mode; allowing it to be manipulated by hand and put in the home position.

- Press the red button (emergency stop).
- Wait 2 seconds then restart the robot.
- Keep the robot disconnected from Brainsight. Disconnect the ethernet connection from the robot to the controller module (i.e. robot ethernet).
- When everything is powered on, press both zero gravity buttons at the same time (back of robot).
- Hold the robot firmly, it should become loose after 10 seconds and manually move the robot joints to their home positions.
- Reconnect the robot ethernet cable and then click on **Reset & Move Home**.



# Chapter 4: Calibrating Robot Tools

The Brainsight robot knows the current position and orientation of the fixed tool assembly at all times. This chapter will show how to use Brainsight's tool calibration function to measure the relationship between the tool attached to the robot fixed tool assembly and the fixed tool assembly itself.

## MANAGING TOOL CALIBRATIONS

Brainsight manages the tool calibrations with an internal database, and you refer to the tool by the name you give it when you calibrate it. Select **Window->Tool Calibrations** to open the calibration manager window (see Fig. 4-1). The calibration manager allows you to create new tool calibrations, re-calibrate existing ones and remove old calibrations.

- To remove one or more calibrations, select it from the list of existing calibrations and click **Remove**.
- To re-calibrate, select the calibration from the list of existing calibrations and click **Re-calibrate**.
- To create a new calibration, click on **New Calibration**.

Fig. 4-1

Tool Calibration Manager.

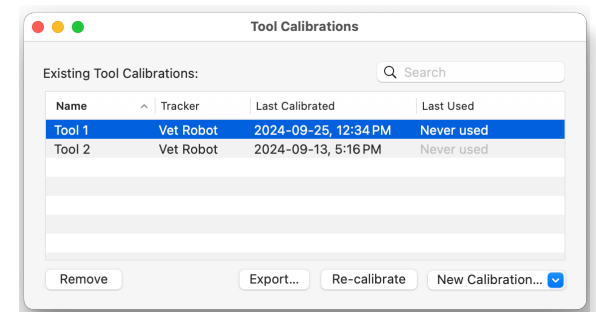

## SETTING UP A TOOL FOR THE ROBOT

The fixed and removable tool assemblies are parts of a universal mating standard that allows you to quickly remove and replace tools in a reproducible way. That is, the position and orientation of the tool (with respect to the robot tool assemblies) will be the same each time. This is a great advantage as it allows you to calibrate each tool once, and quickly place it on the robot during surgery without having to recalibrate it.

Each tool you wish to use, be it the drill or needle must be attached to an appropriate removable tool assembly that is compatible with the fixed tool assembly. While the removable universal joint is standard, the tooling base will be different for each tool and designed specifically to hold the tool securely to the base. Your Brainsight robot will have come with at least three tool mounting bases (one for a drill, one for a needle, etc.). Contact Rogue Research for additional mounting bases for your tools.

## ATTACHING A TOOL TO YOUR ROBOT

Before calibrating your tool, you must attach it to the robot.

1. Make sure the fixed universal joint (fixed tool assembly) on the robot is ready to receive the tool mount by moving the locking lever in the counter-clockwise direction. Note that the lever may be stiff to move.
2. Align the removable tool assembly to the fixed tool assembly, noting the 3 pins on the back of the

**Locking  
Lever**



**Alignment  
Pins**

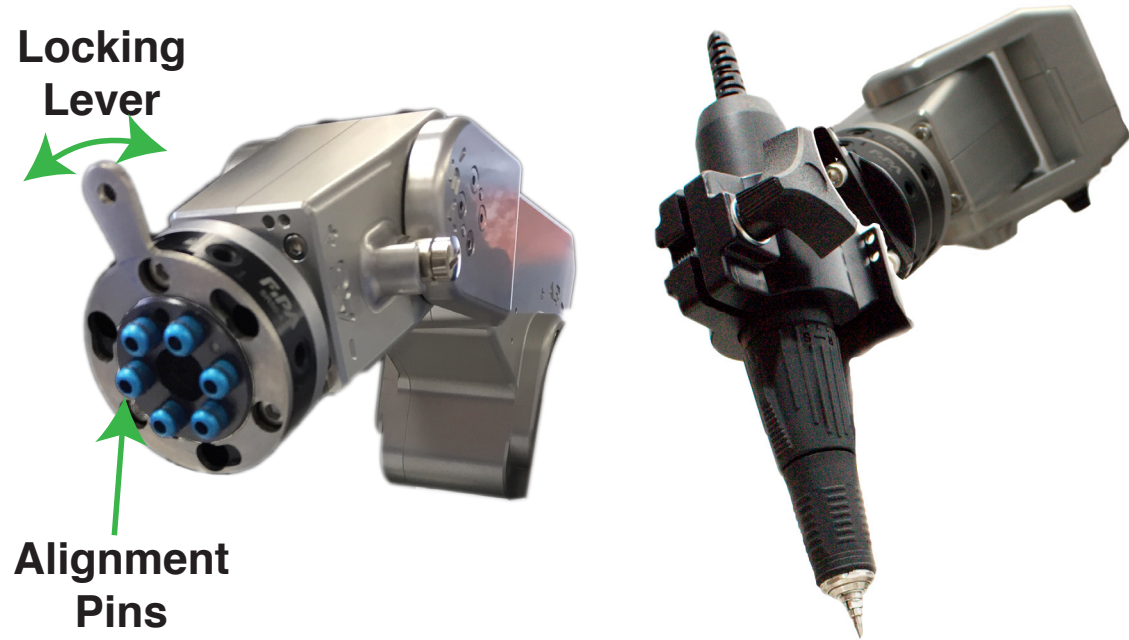

Fig. 4-2

**Mounting a tool to the fixed tool assembly: The tool mounting base (removable universal joint) has alignment holes in the rear that match the shape of the robot's fixed universal joint. The tool base is locked in place by sliding the lever clockwise.**

removable universal joint (tool mounting base) must enter the 3 receptacles of the fixed universal joint (fixed tool assembly).

3. Push the removable tool assembly onto the fixed tool assembly and lock it into place by sliding the locking lever clockwise. Note that the lever may be difficult to reach due to the tool.

Please, note that for best performance, the tool that attaches to the tooling base should not exceed 500 grams.

## PERFORMING THE CALIBRATION

The tool calibration involves using the stereo cameras to visualize the tip and shaft of the tool attached to the robot. The accuracy of the surgery will depend on the accuracy of this step, so care must be taken while performing this procedure. Note that tool registration in only one camera is the default method.

### Move the robot to make the tool visible in the cameras

The tool to be calibrated must be visible in at least one camera view, preferably close to the center of each camera image.

1. If you have not already done so, attach the tool to the fixed tool assembly of the robot.
2. Open the calibration window by clicking **Window->Tool Calibrations** (see Fig. 4-3).
3. Connect to the robot by selecting it in the popup button and click **Connect**.
4. After a moment, you should see the two camera views update. Using the robot controls, move the fixed tool assembly so that the tool tip and as much of the shaft as possible is visible in at least one camera view.

### Identify the tip and shafts in the camera view

It may be necessary to open the app "Pixie" to magnify the images to help identify the tip and shaft.

1. Move the cursor in the first camera view to identify the tool tip. Click **Place Tip** to record the tip location.

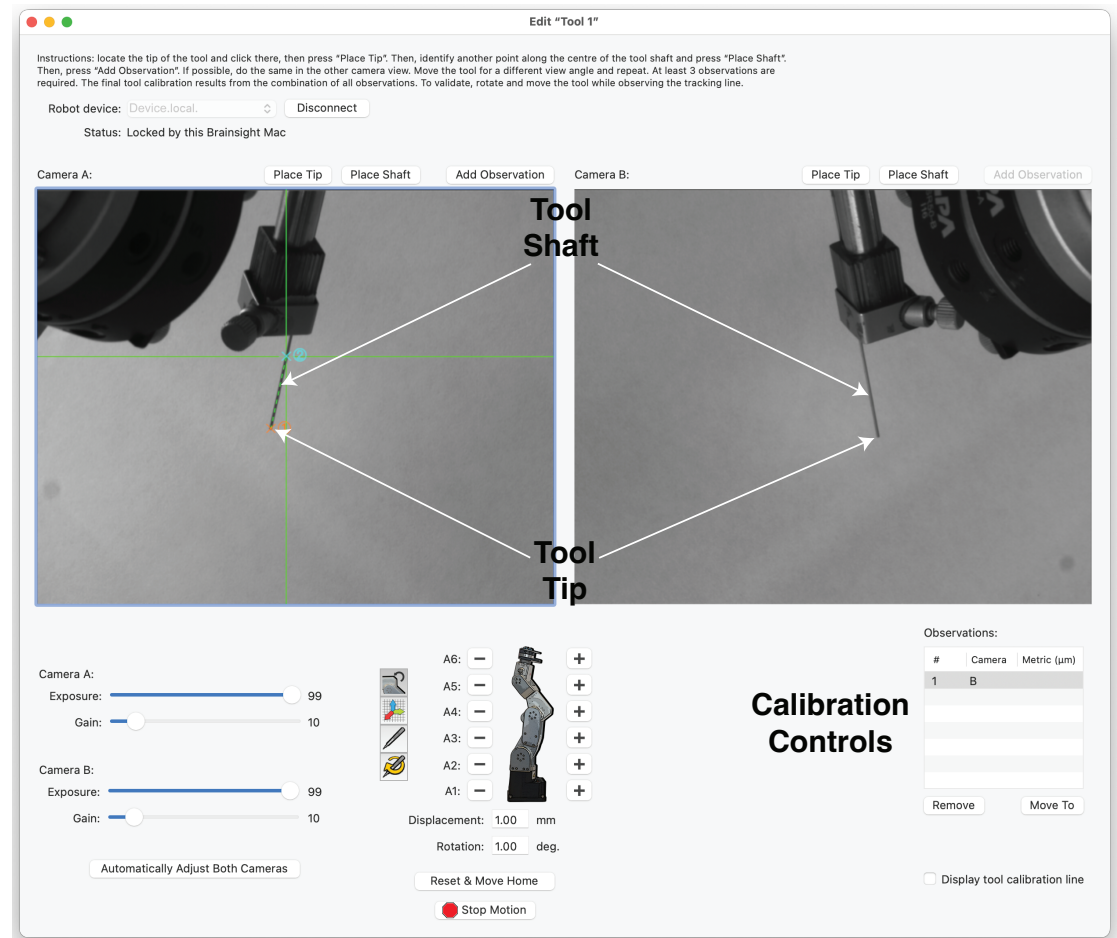

Fig. 4-3

Calibration Window.

**Note that in the case of tools with a wide, the actual tip may not be visible to the camera, so use your judgement to pick the tip** (see Fig. 4-4).

2. Click-drag the mouse in the camera view along the shaft of the tool. Note that an overlay line is drawn from the tool tip to the mouse location. Take care to set the line to identify the centre of the tool shaft. Click **Place Shaft** and **Add Observation**.
3. Repeat the operation for the other camera view by following the same steps above. Note that repeating these steps in the second camera view is optional.
4. To collect additional observations, move the tool using the robot movement controls to view the tool from another angle, then repeat the previous steps to identify (place) the tip and shaft again and add another observation. Note that at least 3 observations per tool are needed for a good calibration.
5. Calculate and save the calibration by clicking **Finish Calibration**. At the end of calibration, if the metric is greater than 60 micrometers, you are advised to re-do the calibration following the DOs and DON'Ts instructions provided at the end of this chapter.
6. Observe the green (tracking) line along the tool shaft in the camera views while moving the robot. Try a few positions and orientations. If the green line is corresponding to the position of the tool, the calibration was successful.
7. Close the window.

Fig. 4-4

Close-up of the tool being calibrated. Right: Close-up of the camera view with the tip and shaft identified. Below: Illustration of the occasion that, for tools with large tips (e.g. burr drill), the actual tip may not be visible in the tool view.

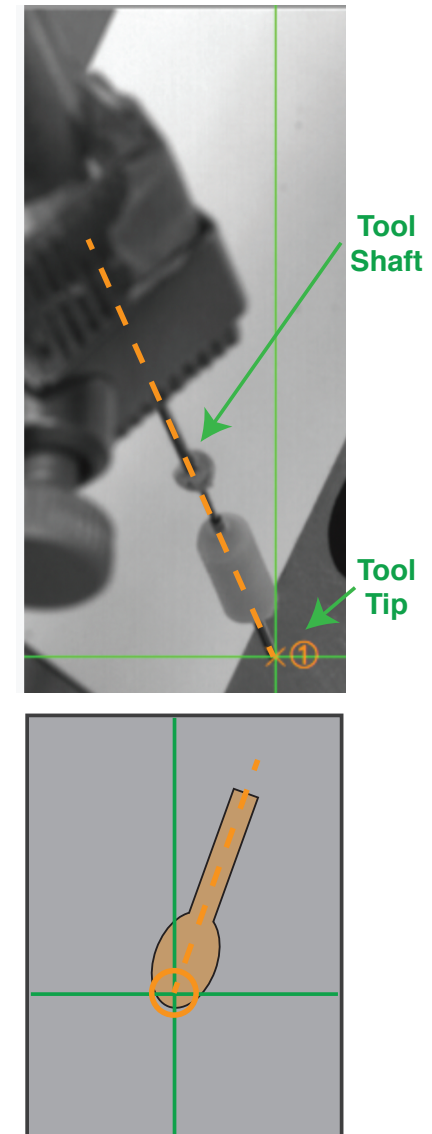
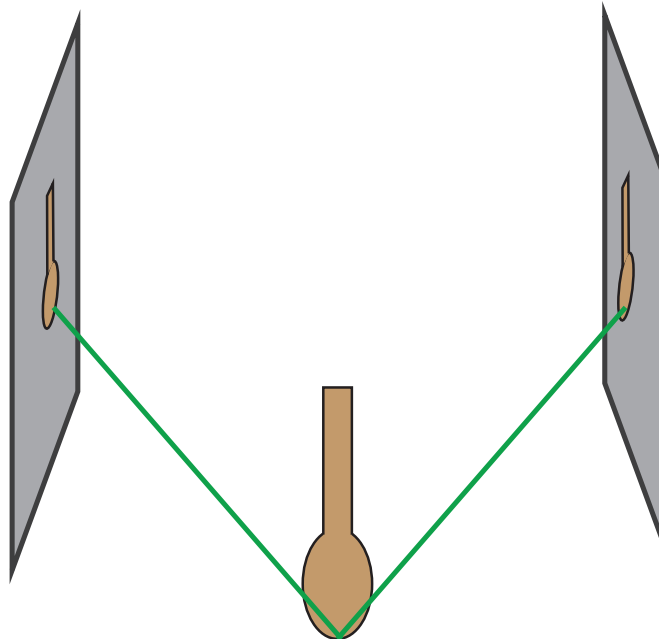



### DOs and DON'Ts with this method

- DO have a tool that is straight. Curved tools cannot be calibrated with this procedure.
- DO have a tool that is thin. The thinner the tool, the better.
- DO have a light coloured uniform background behind the tool in the camera views.
- DO position the tool close to the image center.
- DO orient the tool to make the tool shaft appear long in the camera views, i.e. keep the tool orthogonal to camera orientation.

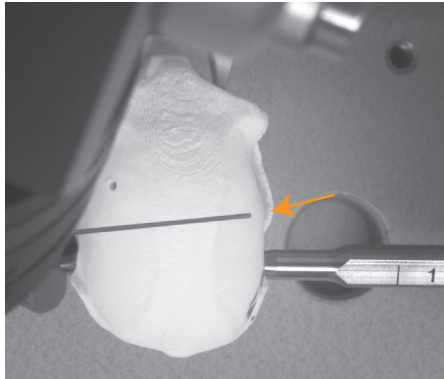

Fig. 4-5

High-contrast edges around the tool and beyond the tool tip in this camera image can lead to mis-detection.

- DON'T have high-contrast edges or other artifacts in the image around the tool (see Fig. 4-5).
- DON'T use lighting conditions which lead to non-uniform colour of the tool shaft (see Fig. 4-6).
- DON'T move the tool too far from or too close to the cameras where the tool might appear out of focus (blurry).

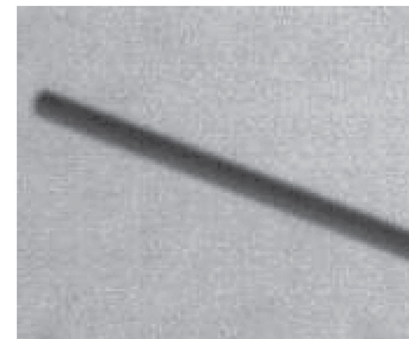
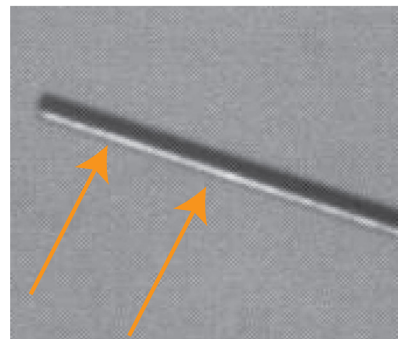
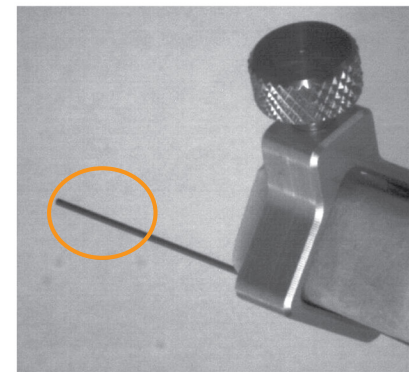
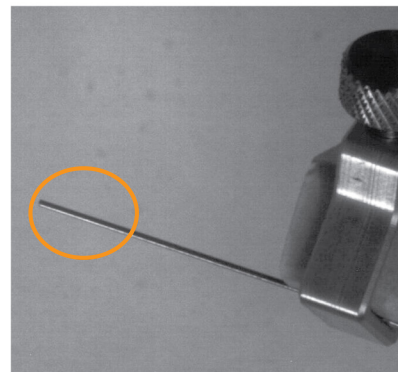

Fig. 4-6

The lighting is not uniform in this image (left) and will not produce a good calibration. Image on right has uniform lighting.

## SOME ADDITIONAL ROBOT TOOLS

### Chamber positioning tool

1. Attach a standard needle to the chamber adaptor tool (fits 24 OD, 19 ID) (see Fig. 4-7).
2. Calibrate the needle as per usual (tip and shaft).

3. Bring the needle into position (center of chamber).
4. Once the needle is touching the skull, loosen the thumb screw and bring the chamber to the skull.
5. Fix chamber to the skull.
6. Loosen all the screws and retract the robot arm.

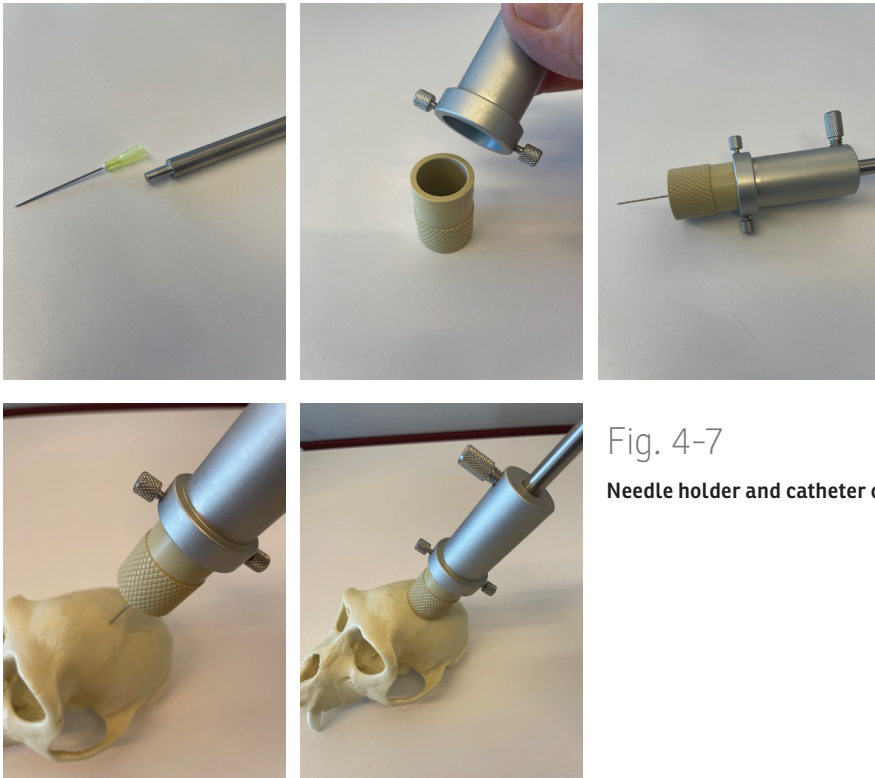

Fig. 4-7

Needle holder and catheter or electrode holder.

### Needle holder and catheter or electrode holder

Insert Hamilton style needles, glass pipettes, electrodes or catheters into the holder (see Fig. 4-8). Other adaptors available on request.

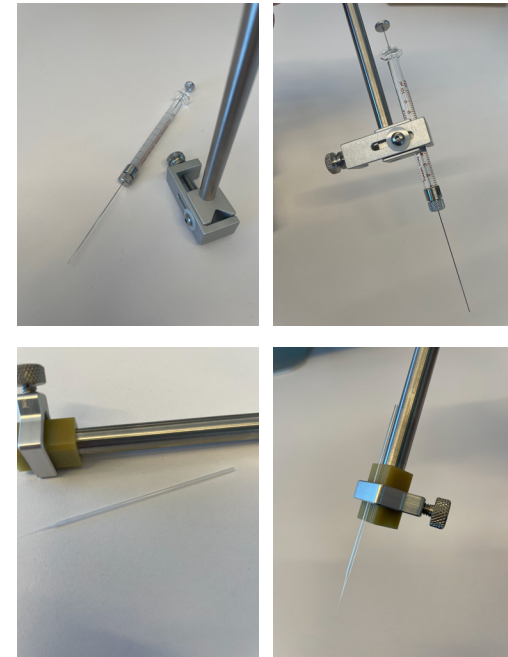

Fig. 4-8

Needle holder and catheter or electrode holder.

# Chapter 5: Scanning Your Subject

The key to a successful surgery is starting with a good scan. The important factors to consider are resolution, contrast and scan time. Unfortunately, improving on any one of the three comes at the expense of the other two.

Strictly speaking, resolution is defined as the smallest object that can be detected by the image, but most people use resolution as the size of the imaging voxel. So an in-plane resolution of 1mm really means a sampling spacing of 1mm in both the x and y directions.

## IMAGE TYPES

Brainsight can accept image data from a variety of sources. In short, any volumetric data set (e.g. CT, MRI) that is stored in a supported file format can be used. Images may be stored in either a volumetric format, where a single file stores an entire 3D volume of data, or in a 2D slice format. In the 2D format case, Brainsight will use the slice location information in each slice to re-stack the slices into the volume that was scanned.

Many imaging protocols are geared however, for direct viewing by the radiologist (e.g. with no image reconstruction), and would not necessarily be suitable for Brainsight. Many of these are focused on the pixel (or voxel) size of individual image slices (often referred to as “in-plane” resolution), and the slice thickness may be significantly larger. If these are stacked together, then the volumetric appearance will look strange in orientations other than the original acquisition. For example, if a 1mm transverse in-plane voxel size scan with a 10mm slice spacing were stacked, the transverse image would look correct, however the coronal and sagittal images would look poor (see Fig. 5-1). Brainsight works best with volumetric acquisitions where the slice thickness is the same as the in-plane voxel size, called isotropic images. Often, changing a protocol to isotropic images will increase scan time.

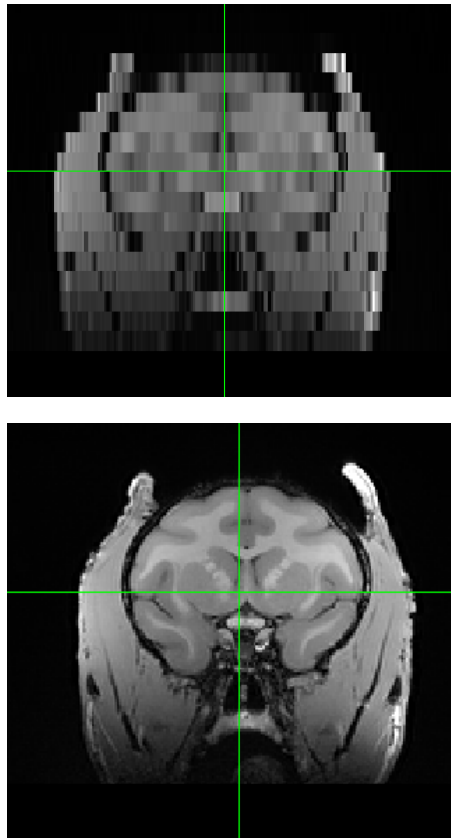

Fig. 5-1

Examples of scans with thick (5mm) and thin slices.

### IMAGING CONSIDERATIONS

This has been discussed elsewhere, but bears repeating. Often, good looking images are images with good contrast. Unfortunately, in MR imaging, contrast comes at the expense of either scan time, or voxel size. When confronted with these choices, contrast is often a better choice. It would be better to have a 1mm isotropic data set with good contrast, than a 0.5mm isotropic data set with poor contrast. Remember that it takes 8 times more scan time to get the same contrast when you halve the voxel size. If you want smaller imaging voxels, be prepared to add scan time.

In CT imaging, scan time (and radiation dosage) is mainly defined by the slice thickness. Try to keep the slice thickness close to 1mm when possible.

### PLACING THE ANIMAL IN THE SCANNER

One of the advantages of Brainsight is that it does not require a stereotaxic frame, or any restrictive holder apparatus. The animal can be placed in any orientation that is easiest in terms of animal comfort and anesthesia access.

#### Placing the animal in the sphinx position

For larger animals (e.g. macaque, dog, sheep), the sphinx position is often the most desirable position.

- Make sure the MR coil you are using (e.g. head coil, knee coil) is large enough to fit the head of the animal and that the receive coil is as close as possible to the animal's head
- Place some cushioning in the bottom of the head coil (or whatever coil you are using). If possible, use a layering technique so you can easily add or remove layers later to help center the head.
- Gently place the head in the coil.
- Once the animal is secure, move the bed into the scanner, and proceed to the next section.

#### Placing the animal in the supine position

For many smaller animals (e.g. marmoset, cat), the supine position may be preferable. It provides easy access for anesthesiology, is easier to configure and may be more comfortable for the animal.

- Make sure the MR coil you are using (e.g. head coil, knee coil) is large enough to fit the head.

- Place some cushioning in the bottom of the head coil (or whatever coil you are using). If possible, use a layering technique so you can easily add or remove layers later to help center the head. If using an implanted array, take note of the expected location of the array (is it in the back of the head) and avoid placing cushioning in that area.
- Gently place the head in the coil.
- Use cushions on top or on the sides to secure the head.
- Once the animal is secure, move the bed into the scanner, and proceed to the next section.

### IMAGING THE ANIMAL

Once in the scanner, select your imaging protocol and set up the scan. While setting up, keep these requirements in mind:

- Make sure that the field of view is large enough to encompass the head and skull of the animal.
- Make sure the scan will yield sufficient contrast to make the structures of interest visible. Remember, contrast is often better than voxel size.
- Try to achieve a voxel size of 1mm (isotropic) or better.
- Note that you do not need to acquire images in multiple planes, as Brainsight will stack any scan into the original volume and re-slice the images as needed. This means that you can spend the time

allotted for scanning on a single scan (with multiple averages, when time permits) rather than multiple lower quality scans.

### ANIMAL AND IMAGE ORIENTATION

One of the pieces of information that is entered into the scanner is the subject orientation. Unfortunately, the scanner manufacturers only had humans in mind when designing the scanner software. When imaging an animal in the sphinx position in the scanner, the scanner operator must choose an incorrect orientation from the available options (since the sphinx position is not listed as a known orientation). The result are images that have mislabelled orientation. For example, images labelled as transverse often appear coronal, and sagittal images appear rotated.

Brainsight has the ability to correct this once the images are located. It will require that you take note of the animal's real orientation during the scan as well as the orientation entered into the scanner console at the start of the scan. Take note of these for use later in Brainsight.

### NOMENCLATURE

Brainsight uses human anatomical nomenclature for its scan orientation. For veterinarian neurosurgeons and neurologists, please note that your coronal refers to axial or perpendicular and axial is your dorsal. Sagittal is the same in both human and animal neuroimaging.



# Chapter 6: Loading Anatomical Images

The anatomical images form the basis for the coordinate system onto which all data is registered. For example, fMRI data is co-registered to it and overlaid. The subject's head (in the surgical clamp) is co-registered to the images to allow the display of the pointer and any tracked tools on the images. For this reason, loading anatomical images is the first step in preparing your project.

The first questions one should ask is: **What kind of images should I use?** The answer to that depends on your application and what scanner you have available. One common mistake that is made is that rather than concentrating on acquiring one or two really good scans, there is a tendency to throw everything in during the session (T1, T2, T2\*, Inversion Recovery, Flair, etc.). It is also a misconception that resolution is the most important (often at the expense of contrast). It would be much better, for example, to acquire one good T1 with 0.5mm isotropic voxels than a 0.3x0.3mm in plane and a 1mm slice thickness data set. Also, a 0.5mm isotropic data set with more averages (to improve SNR) is better than a 0.3mm isotropic scan with the same scan time (lower SNR and hence poorer contrast).

## LOADING ANATOMICAL IMAGES

- Click the file selector (the section highlighted in green in Fig. 6-1) and select **Choose...**, in the popup button. A file selector dialog will appear. Note that you do not need to identify the file format as Brainsight will figure this out automatically. Do the following for each supported file format:
  - MINC: Select the MINC file by either clicking on the file and clicking **Open**, or by double-clicking the file.
  - Analyze (and hdr/img type NIfTI files): These files come in pairs. The header (using the .hdr extension), and the image data file (with a .img extension). Select either file by either clicking on one of them and clicking **Open**, or by double-

Fig. 6-1

Click on the file selector box (highlighted in green) and select "Choose..." from the popup menu.

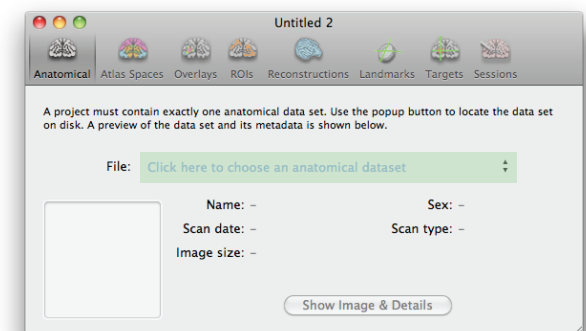

clicking the file. The image file will be opened automatically.

- NIFTI files (using the .nii extension): Select the NIFTI file by either clicking on the file and clicking **Open**, or by double-clicking the file.
- DICOM CD: If your DICOM images came on a DICOM CD, use the free application “Horos” (<https://horosproject.org>) to read the CD and extract the desired scan. Follow the Horos instructions for more details, or follow the instructions in Fig. 6-4.
- DICOM files: All the files for the data set must be in the same folder prior to opening the images. Select any slice of the volume and click **Open**. Brainsight will search the folder for remaining slices from the scan and load them.
- PAR/REC: These files come in pairs. The header (using the .par extension), and the image data file (with a .rec extension). Select either file by either clicking on the file and clicking **Open**, or by double-clicking the file. The image file will be opened automatically.
- BrainVoyager VMR (versions 1-4): BrainVoyager typically performs several image processing steps to convert the native space images into normalized (MNI) space and stores intermediate images. Use the AC-PC aligned images (but not scaled) by selecting the appropriate .vmr file.

Note about DICOM CDs. It is common to receive DICOM files on a CD-ROM formatted in a common DICOM standard. The CD often contains multiple scans and it is difficult to extract the files associated with the desired scan. We recommend using a free application called Horos to read the DICOM CD. The software will read the CD and display a list of scans on the CD (it may take a few minutes to scan the disk and build the catalogue). Simply select the scan from the list, click the **Export** button and select the destination for the scan on your hard disk.

Once the images have loaded, a thumbnail of the scan will appear on the project window along with some details extracted from the header (see Fig. 6-2). To view more details, and if needed, correct the image orientation, click **Show image & Details...** to expand the image view (see Fig. 6-3).

Fig. 6-2

#### Project window with the anatomical MR scan loaded.

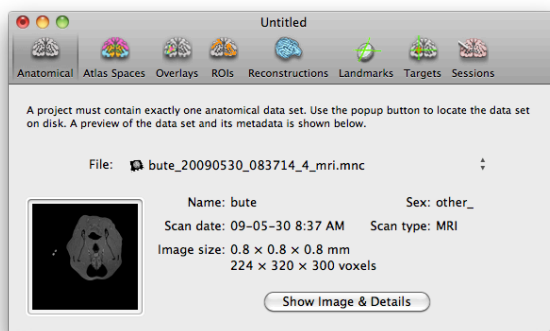

#### VERIFYING AND CORRECTING IMAGE ORIENTATION

If the subject was in the sphinx position during the scan, it is likely that the orientation labeling of the images will be incorrect. This is because the orientation information in the headers is based on the orientation of the subject as indicated by the scanner operator at the start of the scan. Unfortunately, most of the scanner manufacturers did not consider the possibility of a sphinx orientation (they were thinking about human subjects), so the sphinx orientation is not one of the possible selections. If this is the case, the scanner operator would have been forced to select an arbitrarily incorrect value, yielding images with incorrect orientation labels (including potentially an incorrectly labeled right and left values).

You can correct the orientation by following the procedure outlined in Fig. 6-3.

The next section will describe the image display window in detail. The example window is taken from a later step in the data processing workflow (the skin segmentation step) as it shows tools that are normally found throughout the software, with the exception of the anatomical detail view (due to its simplicity).

If the subject was scanned in the sphinx position, the image orientation will likely be incorrect unless the scanner console “understands” the sphinx position and includes it in its list or allowable orientations, or if the images were corrected after the scan by post-processing. If the appearance of the images does not match the labels, then correct the images by following these steps:



Fig. 6-3

### Anatomical Image Detail View.

In addition to showing the usual tri-planar images, the file(s) header information is also kept and shown in detail.

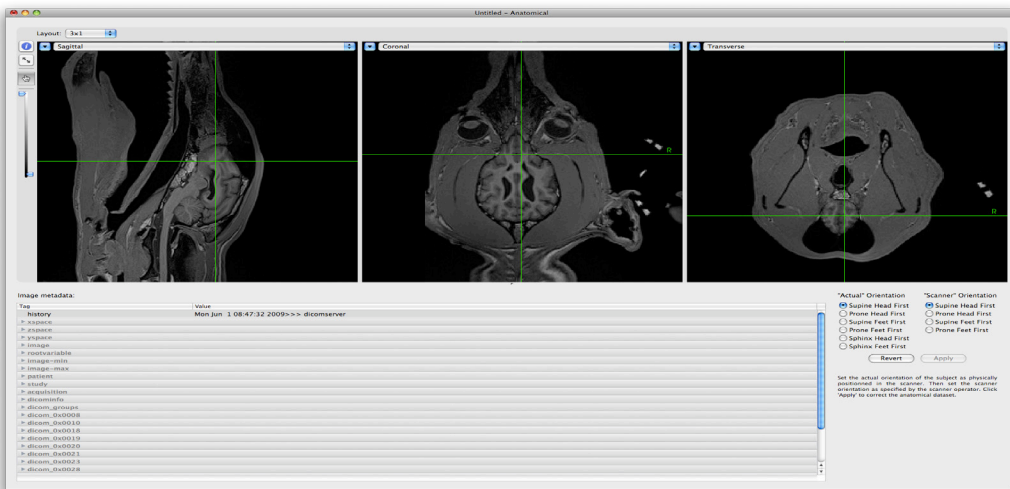

facing up as expected), use “Sphinx Head First” and “Prone Head First” as the actual and scanner orientations respectively. These will yield the proper correction.

### THE IMAGE DISPLAY WINDOW

The image display window, as the name implies, is the main method of displaying image data. The exact configuration of the window depends on the context of the display (i.e. what step in the process you are in). The relevant controls are shown in Fig. 6-5. Different perspectives of the image data are displayed in individual views, called (to no surprise) Image Views.

- Select the actual orientation of the subject during the scan from the “Actual” Orientation list.
- Select the orientation entered into the scanner console during the scan by selecting it from the “Scanner” Orientation list. It is important that this value be correct, otherwise the correction will fail.
- Click **Apply**. After a few seconds, the new orientation will appear. Verify that this orientation is correct. Pay special attention to the right and left sides as this may be less obvious.
- If the images look correct, you can close the window and proceed to the next step. Otherwise, use a different orientation and click **Apply** again. Click **Revert** to undo any changes and return to the image’s original state.
- Note: If the animal was placed in the supine position with the snout facing into the bore (rather than

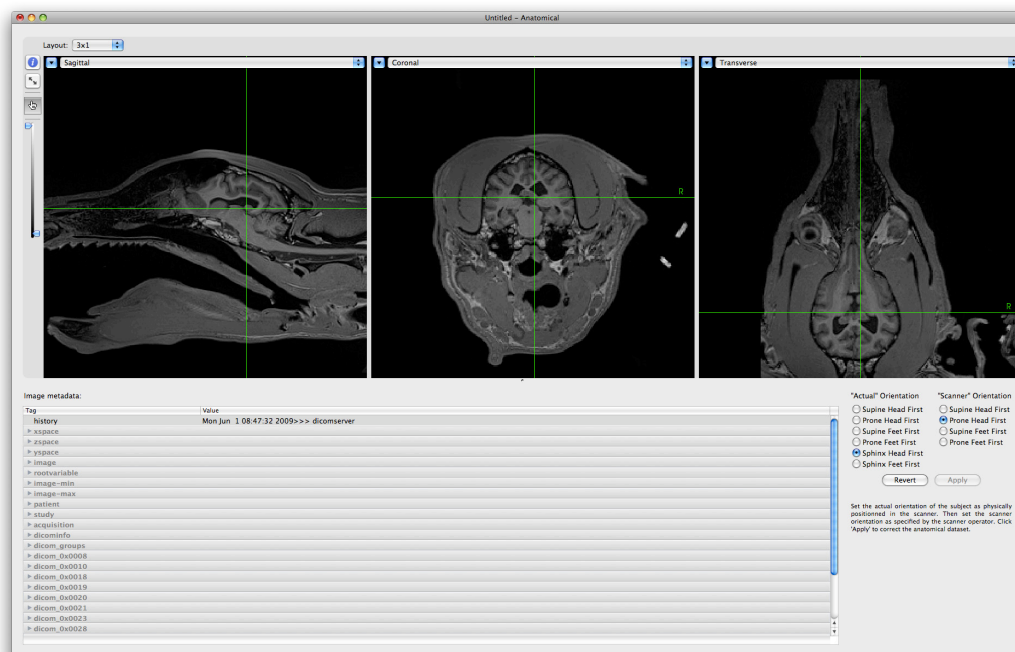
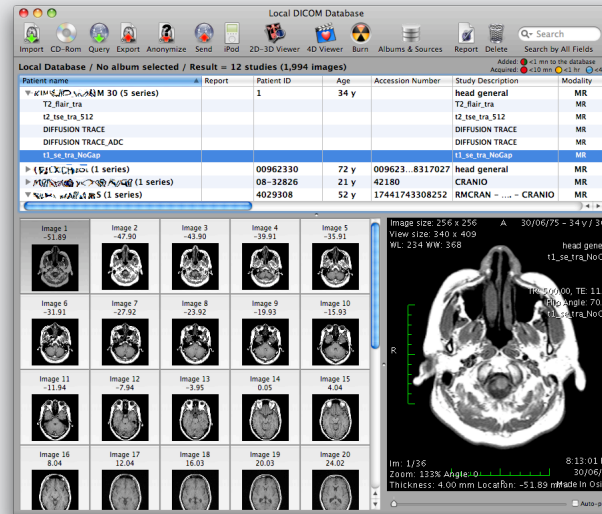
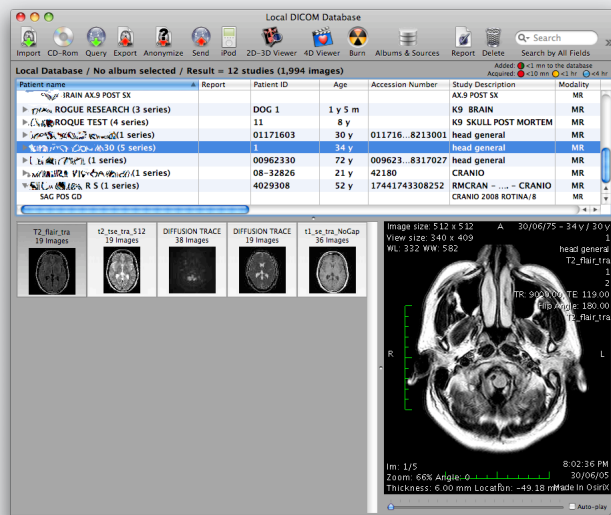

Fig. 6-4

Typical steps for importing DICOM images from a DICOM folder or CD using Horos.

**A:** Launch Horos and click on "Import", or click File>Import>Import Files... Select the desired Image files or DICOM folders and click "Open". It may take a few minutes to scan the CD and load the images.



**B:** Select the scan that you wish to use (make sure it is selected in the list view and that the thumbnail images from the scan appear in the lower left view box) and click "Export".

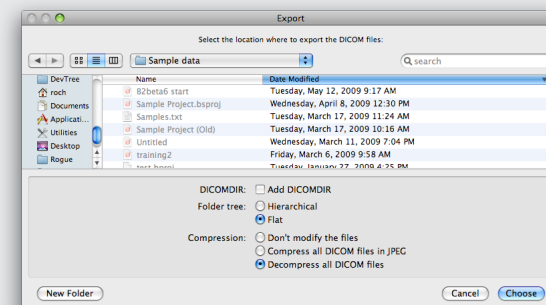

**C:** In Options, select "Flat" and "Decompress all DICOM files". Navigate to your image folder, and press "Choose". Horos will extract and save the scan in a folder using the subject's name and scan number.

### Layout control

Each display window starts in a default layout configuration. In the example of Fig. 6-5, it is a 2x2 layout. The layout can be changed using the layout popup menu.

### View configuration (HUD)

Configure each image view (if desired) by clicking on the HUD button (we call it a HUD, for Heads Up Display because the window floats over the image view when invoked). When viewing a 2D image, you can change the zoom (note that the zoom applies to all 2D views); while viewing a 3D image, you can also change the image orientation.

Note: Many image manipulations are performed without needing to invoke the HUD. For example, option-click-dragging the image performs panning, while option-scroll wheel zooms the image. Zooming in on a 2D image view will apply to all 2D images, while zooming in on a 3D view only applies to that view. Panning always applies to the single view only.

### View selector

You can change what is being displayed by clicking on the view selector. A series of common views and a customize option are listed, where you can select exactly what you wish to view from an array of options (see Fig. 6-6).

### Inspector

Invoking the inspector opens a control window that allows you to change certain context sensitive window

Fig. 6-5

Typical image view window with the important controls highlighted.

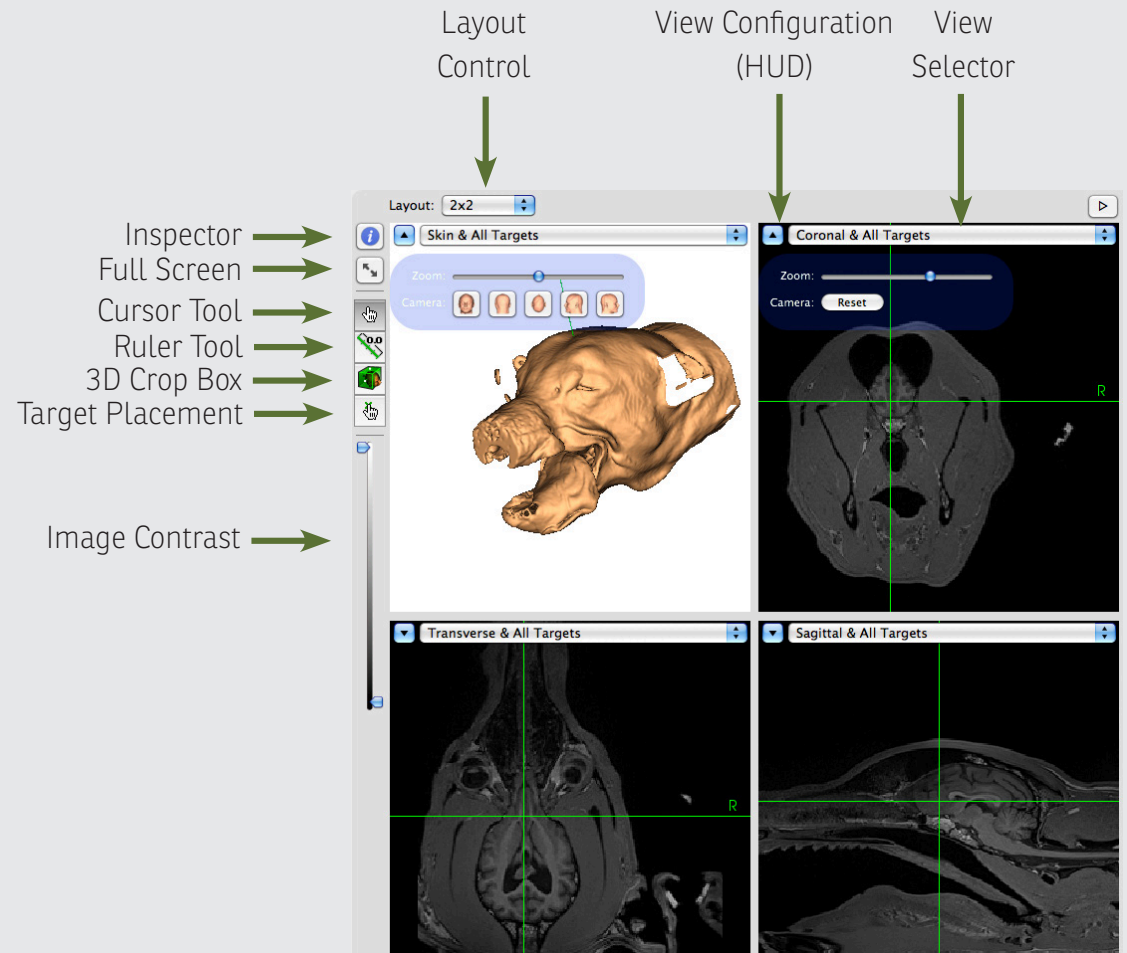

settings and the appearance of ROI (Fig. 6-7 C) and overlay image data (see Fig. 6-7 B). From this window, you can also choose the peel depth of curvilinear reconstructions (see Fig. 6-7 A).

### Full screen control

This button toggles the view window in/out of full screen mode. You can use full screen mode if you want to maximize the amount of screen space used for image display.

### Cursor tool

The new “smart” cursor tool replaces the multiple tools found in Brainsight 1 with gesture interpretation to determine your intent when clicking the mouse. When clicking the mouse on the images, one of several things may occur depending on the context of your motion:

- Single-clicking (without motion) on the image moves the cursor to that location (both for 2D and 3D views).
- In a 3D view, clicking and dragging rotates the image. Clicking inside the blue circle (it appears when you click) rotates the objects in the direction you click. Clicking and dragging outside the circle rotates in a twist direction.
- Click-dragging with the option/alt (⌘) key down pans the image.
- Option-scrolling (using the scroll-wheel, or track-pad) zooms the image (both for 2D and 3D views).

- Click-dragging on a 3D object with the command (⌘) key down will trace the cursor along the surface of the 3D object.

### Ruler tool

This tool can be used to measure the distance between two points on a 2D view. Click on the start location and drag to the end point. You can refine the end points after by clicking and dragging them around on the screen.

### 3D Crop box

This mode works in conjunction with a 3D object (e.g. skin) displayed in a 3D view. When invoked, you can click on a 3D surface (except the curvilinear objects) to activate the box (see Fig. 6-8). You then move the walls of the box in and out by click-dragging the spherical handles to set a clipping plane location. Letting go of the handle updates the clipping of the object according to the clipping box. Once done, turn the box off by selecting the smart cursor again.

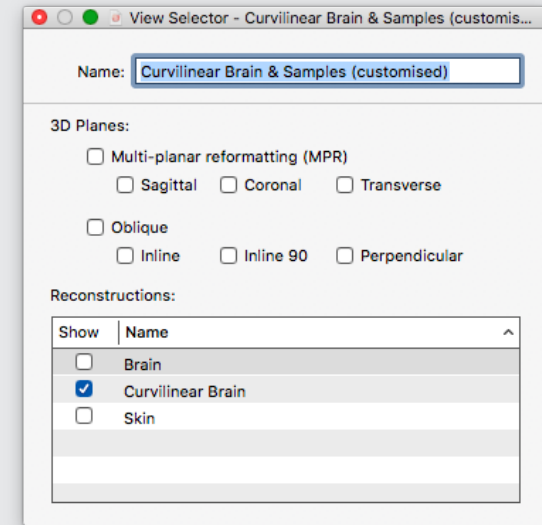

Fig. 6-6

### Customize display control window.

You can customize what is displayed in any Image View using this control:

**3D Planes:** Allows you to select one or more planar slices for viewing.

**Reconstructions:** Allows you to select one or more 3D reconstructions generated from the 3D reconstruction step.

Fig. 6-7

A: Curvilinear surface inspector.

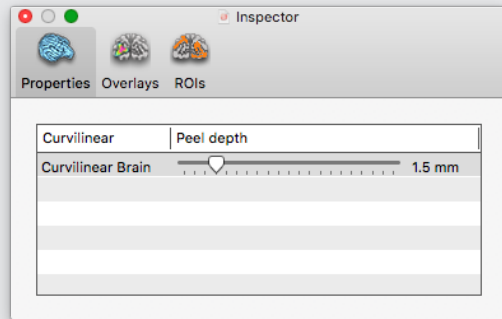

B: Overlay inspector.

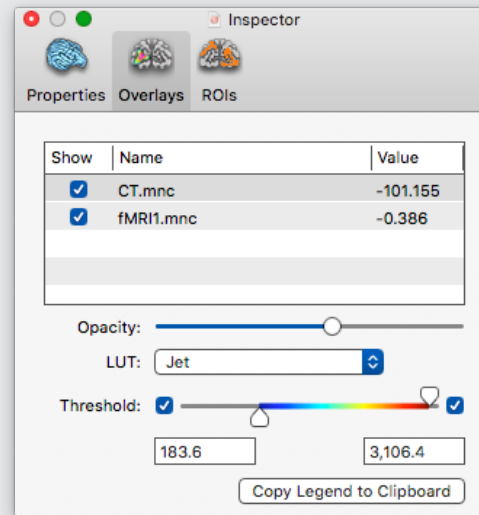

C: Region of Interest inspector.

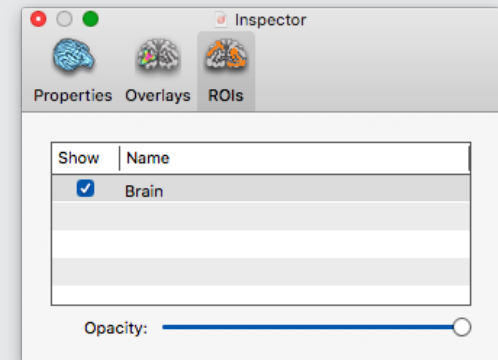

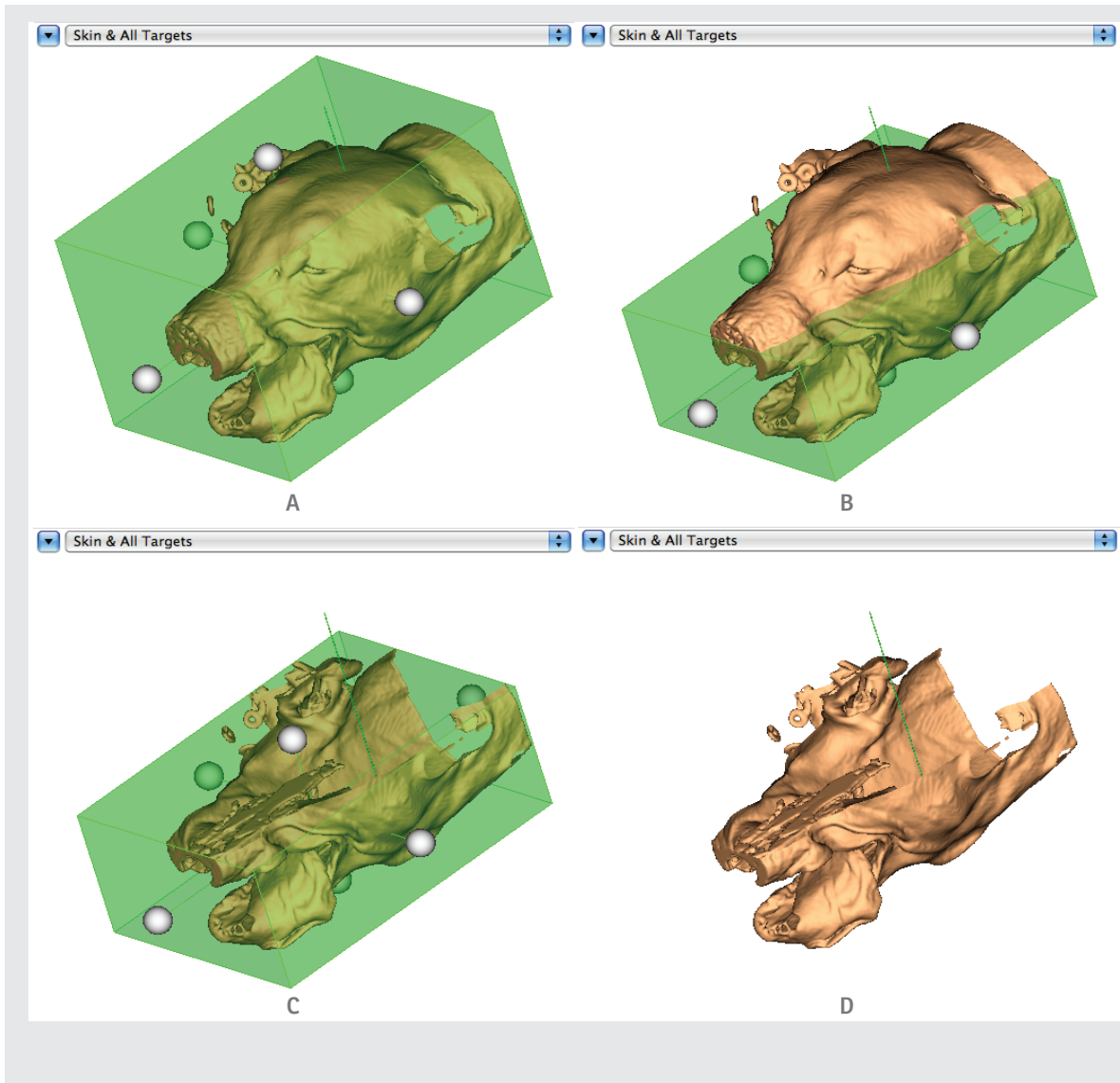

Fig. 6-8

Using the clipping box to clip an object (e.g. skin).

A: Move the walls of the box by dragging the spherical handles (click-dragging).

B: The upper wall was dragged down into the head.

C: The head is cropped according to the bounding crop box.

D: The crop tool is deactivated (by selecting the smart cursor tool) leaving the cropped object. Note that the box only applies to the object selected. Other objects inside the skin would remain whole unless another crop box is invoked and changed for it.

Note that you can manipulate the spherical handles even when they are buried (occluded) within another surface as long as you can predict their location and click on them with the mouse.

# Chapter 7: Atlas Registration

This step is only required if you wish to co-register the subject's image data to an animal brain template.

Fig. 7-1

**MNI Registration Manager.**

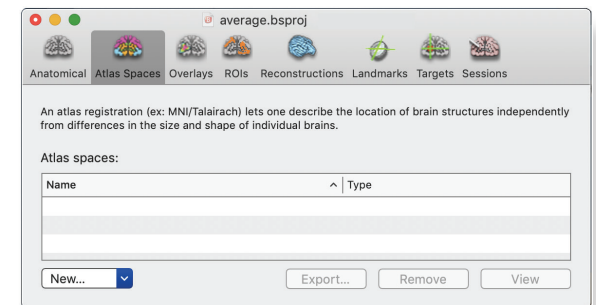

The relationship between the native MR images and the atlases can be represented in many ways, depending on the type of transformation. Currently, Brainsight supports a linear transformation, which can be represented by a single 4x4 matrix. You can either use a pre-existing transform from another program (e.g. MINC tools), or perform the procedure manually here.

Note: As updates to Brainsight are released, transformations from a wider variety of software programs will be added. Please let us know which ones are important to you.

## MANUAL MNI REGISTRATION

Select **Manual (AC-PC-box)** from the **New...** popup menu, and the MNI registration task manager will appear (see Fig. 7-2).

- Move the cursor to the centre of the anterior

Fig. 7-2

Initial manual MNI registration window.

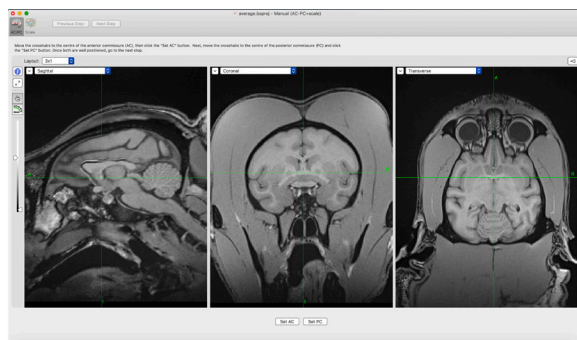

commisure (AC) and click **Set AC**.

- Move the cursor to the centre of the posterior commisure (PC) and click on **Set PC**.
- Adjust either (if needed) by moving the cursor to the desired location and clicking either **Set AC** or **Set PC** again (see Fig. 7-3).
- Click on **Next Step**.
- Set the size of the bounding box to the outer limits of the brain on the AC-PC axis. Pay special attention to the coronal view for setting the left/right and superior/inferior limits and the transverse for the anterior/posterior limits (see Fig. 7-4).
- Select the atlas to register to (rhesus, cynomolgus macaque, an average of the two; Saleem99

Fig. 7-3

MNI registration step with AC & PC identified.

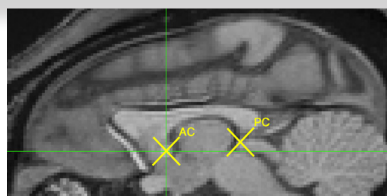
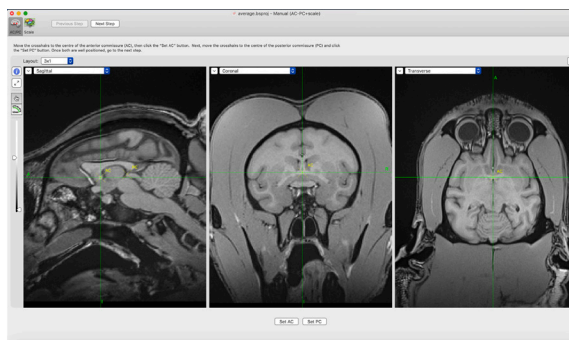
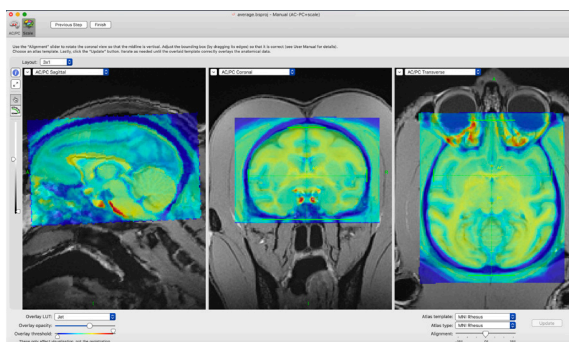

Fig. 7-4

MNI registration step with box set to brain bounds.



(macaque); marmoset; ovine; porcine) by selecting them in the **Registration type** and **Overlay type** popup menus.

- Click **Update**. In a moment, the registration will be calculated to the appropriate template that you selected (rhesus, cynomolgus, etc.) and the average brain will be warped and overlaid on your MR images. Examine the quality of the fit visually. You can change the opacity back and forth to better evaluate the fit. You can interactively adjust the bounding box around the brain and click **Update** to adjust the fit until a reasonable fit is obtained.
- Click **Finish** to complete the task.

### LOADING A PRE-EXISTING MATRIX

If you have the file containing the registration matrix (MINC tools), choose **From .xfm...** from the **New ...** popup menu button (see Fig. 7-1, and select the file, otherwise choose **From Matrix**). Note that a window displaying anatomical images with the average brain (warped using the loaded matrix) will appear (see Fig. 7-5). The actual matrix is also displayed on the top left of the window.

If the overlay does not match the anatomical data (particularly if it does not agree with how it looked in your other software), then you may need to manipulate the matrix. Currently, you can invert and/or transpose the matrix (by clicking the **Invert** or **Transpose** buttons) or edit the matrix manually by typing in the numbers directly.



Fig. 7-5

Verification screen for MNI registration. Registration matrix is shown at the top left.

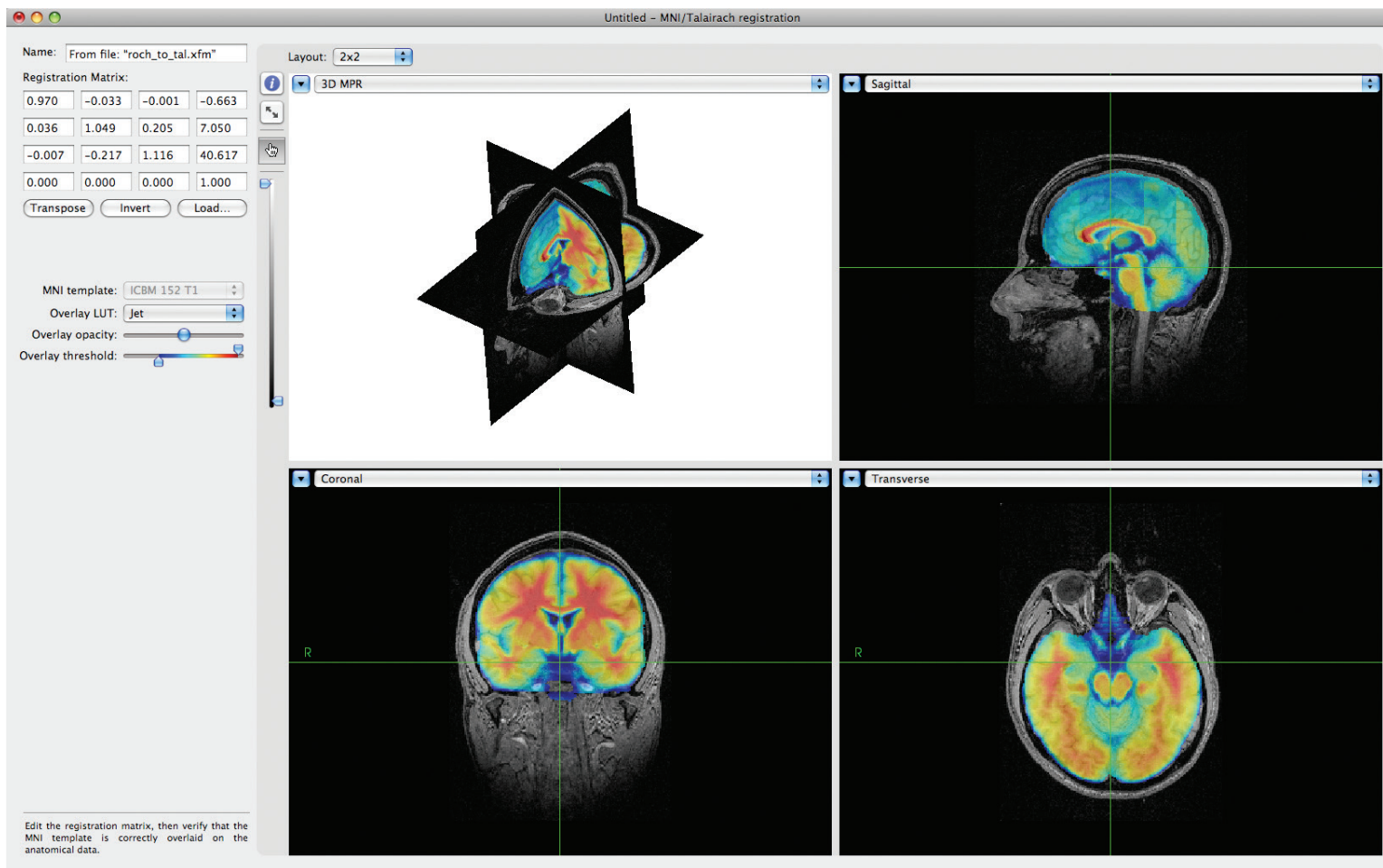



# Chapter 8: Image Overlays

In addition to using atlas coordinates (MNI, Paxinos, etc.), you can load functional or other anatomical data, (e.g. a T2 MRI) and overlay them on the anatomical MRI. You can also overlay an Atlas and warp it from its MNI reference space to the native shape of the subject.

Fig. 8-1

## Overlay Manager.

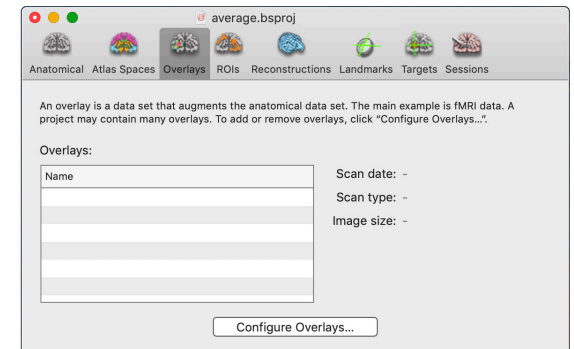

Click on **Configure Overlays...** to add or edit overlays.

## ADDING FUNCTIONAL OR ANATOMICAL OVERLAYS

Overlays are simply volumetric data sets that have some intrinsic meaning to you. In the case of functional or anatomical data, the data should be in the native space of the subject.

- To add a new overlay, click **Add...** (see Fig. 8-2). Select the image file (using the same rules for the different file formats as was applied for the anatomical image data as described in Chapter 6).
- The file needs to have been co-registered using another software program (and either re-sampled, or the registration matrix exported to be entered here). Select the registration method used:
  - If the data set was re-sampled to match the

anatomical, select **None** as the registration.

- If the method stored the registration to the anatomical images in the header (as is sometimes done with MINC and NIFTI), select **From headers**.
- If a matrix is used, select **Matrix...** and enter the matrix manually, or by loading a supported matrix file format (only MINC .xfm files at the moment). When entering a manual matrix, take special care to ensure that the matrix is correct by observing the orientation and fit of the overlay on the anatomical images.
- For an atlas file, use **From current ATLAS registration** (see “Loading MNI monkey labels atlas and Paxinos labels for overlay”).
- Set the threshold of the images. Note that Brainsight does not support showing both positive and negative changes in response at the same time. You can work around this limitation by loading the overlay twice and setting the thresholds to display the positive on one, and the negative on the other.
- Select the desired lookup table (LUT) using the **LUT** popup menu button.

You can load multiple overlays, and select which ones you want to be visible by default by enabling/disabling the visible checkbox next to each entry. You can also change the order of overlays by dragging the images in the list around to set the desired order. When finished, close the overlay window by clicking on the close button

Fig. 8-2

### Overlay window.

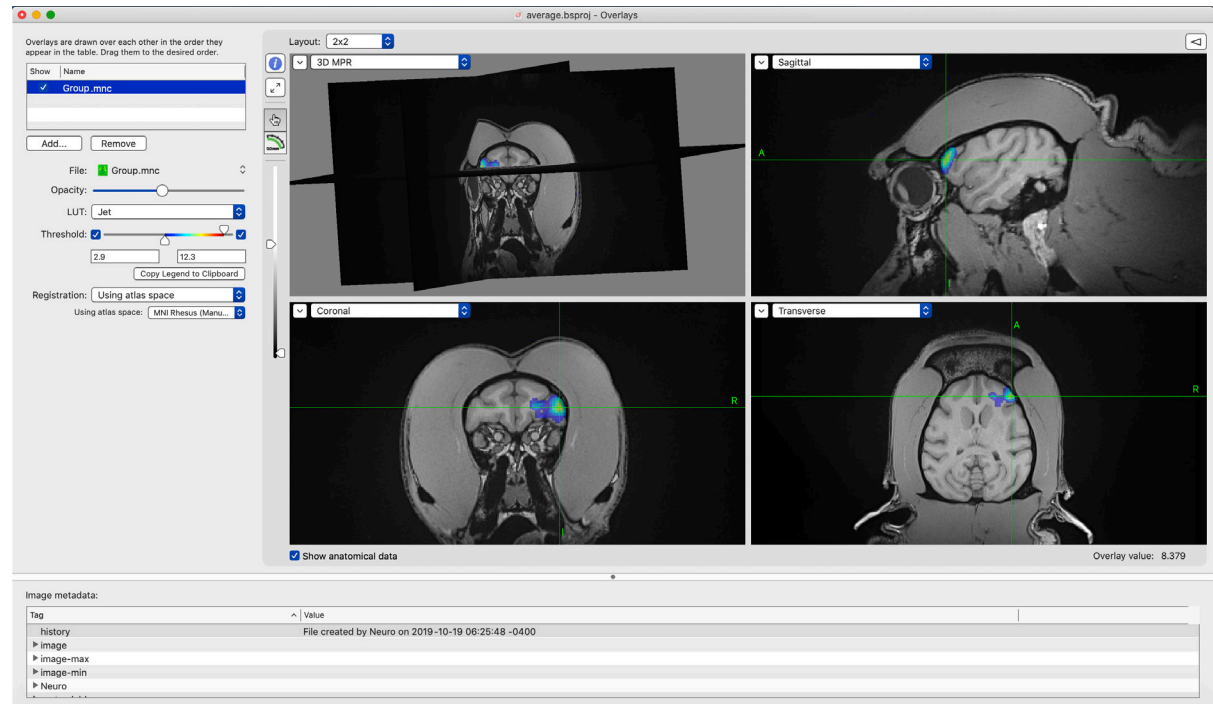

at the top left of the window.

### LOADING MNI MONKEY LABELS ATLAS AND PAXINOS LABELS FOR OVERLAY

You can load an overlay onto an Atlas however there are a few requirements:

- You need to perform an MNI registration (see Chapter 7) so the software knows how to transform native space to/from MNI space.
- The Atlas file needs to have defined the transformation from the image voxels (voxel space) to the MNI space, stored either in the header or as a separate transformation file. Atlases in MINC format usually have this embedded so they should work. Other formats (e.g. NIFTI) will need to be validated first.
- In this version of Brainsight, the atlas must have 256 indexed regions or less.

To load an atlas as an overlay:

- Click **Add...** and select the atlas file using the file selection dialog that is shown.
- Once loaded, select **Atlas** as the LUT (it is an indexed colour table to maximize the contrast between adjacent atlas regions).
- Select the **Registration** method.
- Verify that the Atlas overlays correctly on the anatomical images.

Fig. 8-3

Overlay window with atlas.

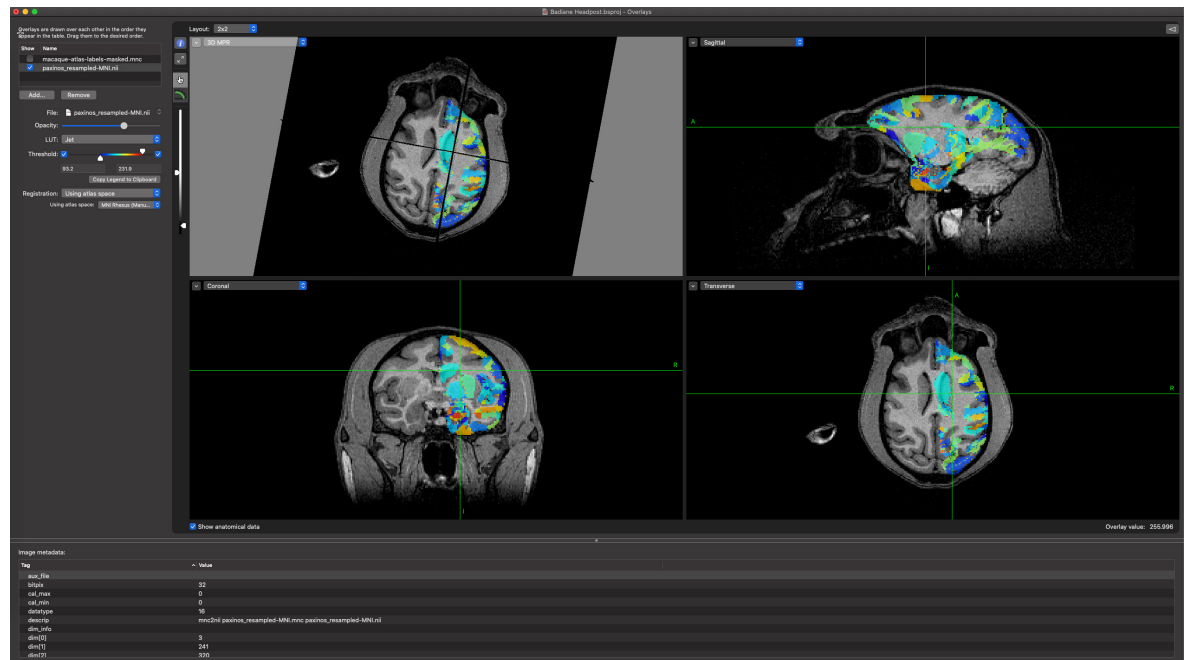



# Chapter 9: Region of Interest (ROI) Painting

## INTRODUCTION

In previous versions of Brainsight, the 3D segmentation tool combined two steps of building 3D representations of objects “painted” from the MR data: Region painting and 3D reconstruction. Brainsight 2 breaks up these two steps to make better use of the voxel painting tool (ROI, or region painting tool) for other purposes. For example, one might use the ROI tool to identify particular regions as seen on an atlas to highlight them in the 2D views. Once the region has been painted, it can be treated as any overlay and displayed in any of the planes.

This chapter will first describe the use of the ROI tool in general, then provide examples of the two most common applications of the ROI tool, to segment the brain and skull. This process will take a bit of practice to master, and this step will take more time than any of the other steps in using Brainsight, but the results will be well worth the investment in time and effort.

Region painting refers to the process of segmenting the region you are interested in (e.g. the skull, or a particular brain structure) from the surrounding data by labelling it somehow (e.g. painting image voxels) as illustrated in Fig. 9-1 A. 3D reconstruction can take this labelled data and create a 3D surface (3D mesh) to be displayed and manipulated as a discrete object (see Fig. 9-1 B).

Fig. 9-1

**A: Example of a painted Region of Interest (ROI).**



**B: Example of a 3D surface representation of the edge of the ROI using the “Surface from ROI” described in Chapter 10.**

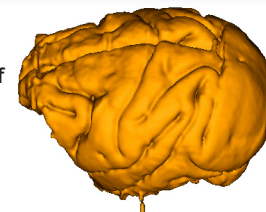

Brainsight currently supports manual region painting to create and edit ROIs. The manual paint tools include seed/threshold and manual paint/erase. The threshold/seed tool is useful if your structure of interest contains a distinct region that can be isolated by selecting an intensity range. Think of the seed tool as a persistent flood fill (often called a paint bucket) tool, which spreads “paint” to all connected voxels that fall within the threshold intensity range. You typically set an intensity range for your structure then drop a seed in the structure. The seed will initiate a fill operation at the seed location (see Fig. 9-2). You then go to the next slice, and the seed will follow you to that slice, and initiate a fill again. The seed is smart enough to search a small area for the threshold if it lands on a new slice outside of the threshold area (this can happen if the shape of the structure changes from slice to slice).

The manual painting tools can be used to delineate areas that are not strictly intensity based, or where the seed/threshold either missed a spot, or filled into an unwanted area (despite being within the threshold bounds). For example, the skin reconstruction can usually be performed automatically because there is a large difference in intensity between the skin and surrounding air. The brain can also be isolated (mostly) except in regions where there might be structures with similar intensity ranges that exit the brain cavity into other areas (e.g. optic nerves). In these cases, you would let the seed(s) apply to the slice, and use the paint/erase tools to edit the results to conform to the structures.

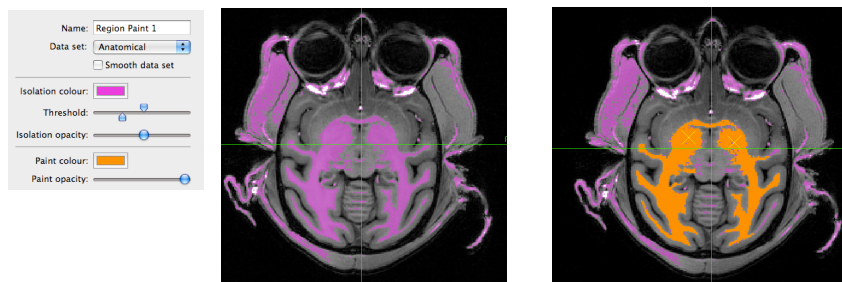

Fig. 9-2

**Concept of the threshold and seed method.**

### CREATING AN ROI

This section will cover creating an ROI and explain the use of the tools as they are needed. To create an ROI, select the ROIs tab at the top of the project window then click **New ROI from Region Paint** (see Fig. 9-3). The region paint window will appear (see Fig. 9-4). The window will have a layout with 4 image view panes. The larger view is the painting view, while the other 3 are for location reference. Clicking in the 3 smaller views will move the cursor. Clicking in the paint view will perform an operation that depends on the currently active tool.

If your structure can be isolated by a range of image intensities, then:

1. Set the orientation in which to paint by selecting it from the view selector popup menu of the painting view. You can change orientations anytime and continue painting in the other slice (although that can get confusing).

Fig. 9-3

**ROI manager.**

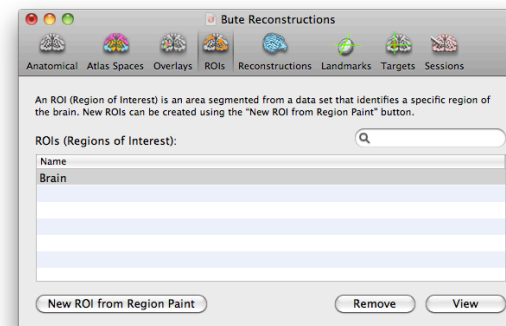



- Optionally, click on **Smooth data set** to apply a 5mm Gaussian smoothing kernel to paint from a smoothed version of the data. This will reduce sharp edges but will also blur out small structures.
- Use the threshold sliders to set a range of intensities that help isolate your structure of interest. The voxels that fall within the upper and lower threshold bounds are referred to as the isolated voxels, and are displayed in purple (you can change that colour by clicking on the colour indicator box and selecting a new colour using the colour picker, and the opacity using the opacity slider). See Fig. 9-4.
- Select **Seed** (among the painting tools as shown in Fig. 9-6) and click in the region of interest. The result will look like Fig. 9-5 B.
- If the structure of interest consists of multiple disconnected regions that are isolated using the threshold values, add seeds to those regions by clicking in them.
- If a region that is not isolated by the threshold values exists, you can use the Pencil and Fill Region tools to include it manually. Select **Pencil**, and draw the border of the region (see Fig. 9-5 C). Select **Fill Region** and click in the middle of the region to fill the region (see Fig. 9-5 D). Note that you can avoid clicking back and forth between the Pencil and Fill tools by remaining in the Pencil tool, and flood fill by option-clicking where you want to fill.

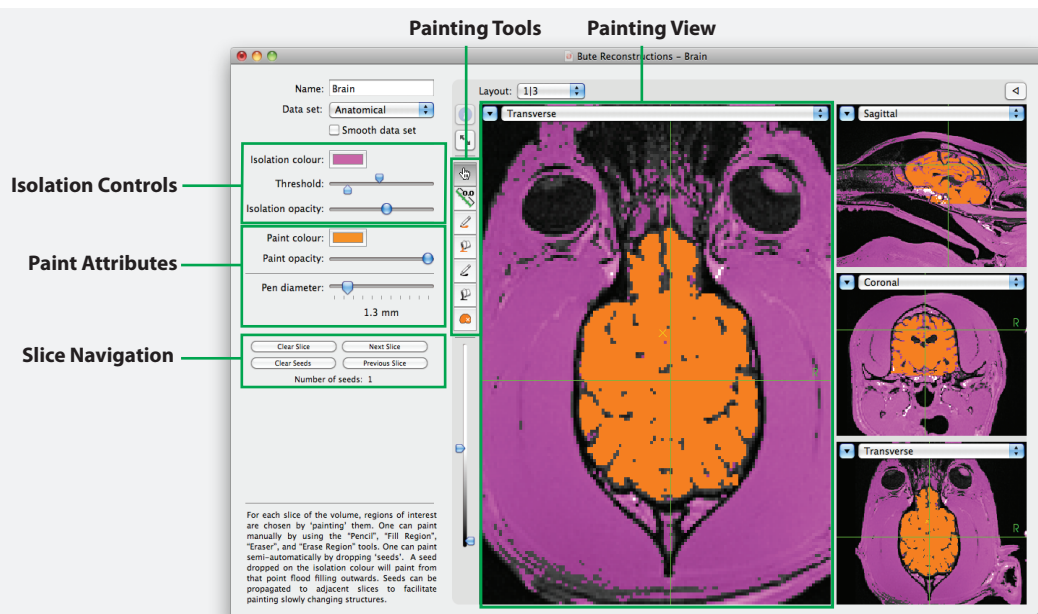
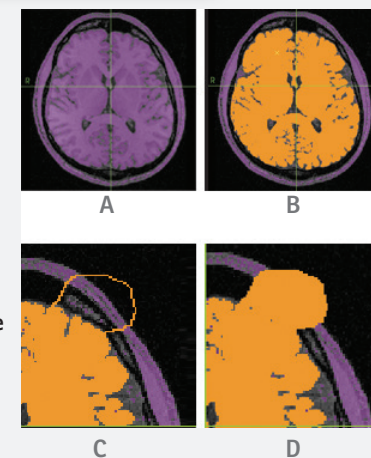

Fig. 9-4

**Region painting tool.** The area in purple is referred to as the isolated region. It represents the voxels in the displayed slice that fall within the threshold range set using the threshold sliders which are part of the isolation controls. The painted region is shown in orange (in this example) and is generated by the seed/threshold.

Fig. 9-5

**Region painting tool, using seed/threshold and line paint/fill methods.** Line erase/clear fill work the same way as the line paint and fill except they erase painted voxels.



7. To exclude a region that was mistakenly included, select **Eraser**, and use it to delineate the “offending” part from the rest of the painted region, then use the Erase Region tool to clear the region by clicking on the isolated paint region. Note that as with the Pencil and Fill tools, you can remain in the Eraser tool, and option-click the region to apply the Erase Region tool to it. **Undo** in the tool bar can also be used.
8. Once the region has been painted, proceed to the next slice by clicking **Next Slice** or **Previous Slice**.
9. Notice that any seed in the last slice is propagated to the new current slice and applied to paint the slice. Add seeds as needed and manually add/remove painted regions as in the previous steps.
10. If you find that after several slices that you have too many seeds (e.g. disconnected structures in previous slices are now joined, or the seeds have migrated to unwanted regions), click **Clear Seeds** to remove all the seeds, and then click **Clear Slice** to erase all the paint in the slice and start fresh.
11. Once you have painted the entire region, close the window. This is probably a good time to save your project.

### SEGMENTING THE BRAIN AND SKULL

The description of how the ROI tool works is technically enough for you to be able to segment any structure you want. There are however, tips and tricks that can be used to minimize the time and effort to segment common

structures. This section will step you through the process of segmenting the brain and skull, since these are the most commonly requested.

**Conceptually, the Pencil/Eraser and Fill Region/Erase Region tools are opposites of each other. The Pencil and Fill region delineate voxels while the Eraser and Erase Region clear voxels.**

Fig. 9-6

Close-up of ROI tool listings.

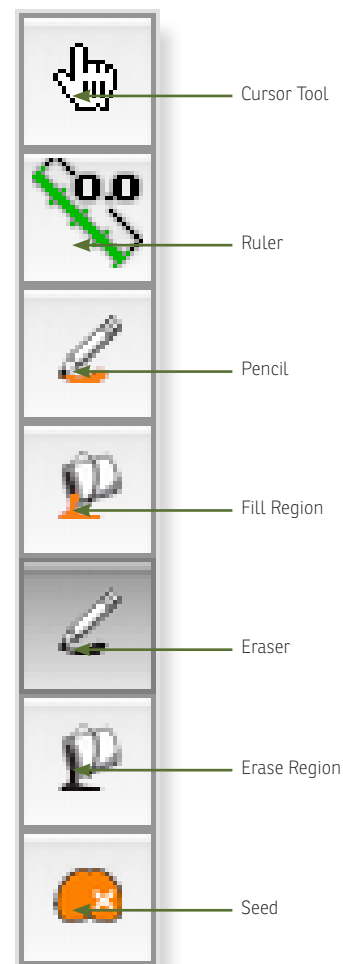

### A note on image quality

As noted before, the quality of the image will have an impact on how useful they are for neuronavigation. The ROI tool is where this is most keenly observed. After performing a few segmentations on noisy data, you will likely wish to take a new look at how your images are acquired. If you are not performing the scanning yourself, discuss this with your imaging staff. It is worth having a discussion (it may be awkward, but the result may be better scans for years to come). Perhaps ask to perform some test scans to explore the basic trade-offs that are made between resolution, contrast and scan time. When looking at your protocols, focus on the following:

**-Resolution:** Do you really need 0.3mm voxels? Try 0.5 or 0.8mm instead and use the freed up scan time to increase the number of averages. The term is different for different manufacturers, sometimes referred to as NSA or NEX. Also, 4-5mm slice thickness won't cut it either. Bring it down to 1 or 1.5mm at most.

**-Contrast:** In our experience, this is the most poorly understood concept in imaging. In short, contrast range is the range of intensity values in the images from the darkest to the brightest objects. Contrast resolution is how fine the steps are within that range. This affects the ability to distinguish the difference between two similarly intense objects. If the contrast range of the image is poor (the image might look very dark at the start before windowing), then objects of similar intensity will tend to blend in because the data is compressed (in the

intensity sense) at the loss of contrast. Also, noisy images mean that the fluctuation in intensity between voxels of the same structure makes it difficult to discriminate them apart. The solution to poor contrast is simple. Either give up some resolution or increase the scan time (or both). For example, if your scan is 8 minutes, doubling the number of averages will double the scan time but improve your image noticeably. If you are on a 0.5T system, don't expect an 8 minute scan to give you anything really good (and don't let anyone convince you otherwise). If there is a debate, do one test scan with enough averages so that the scan time is around 30 minutes (especially on a 0.5T) and see the difference. Then you can look at how much scan time you can give up at the expense of contrast until the images are just acceptable.

### Segmenting the brain

Segmenting the brain is not any different than segmenting any other structure. You will use the intensity threshold controls to try to isolate the brain from the surrounding tissue (e.g. dura) and then drop one or more seeds to start the segmenting process. Along the way, as needed, you will remove unwanted voxels that were "painted" by the seeds.

- Select the ROI tab, then click **New ROI from Region Paint** to open the ROI painting window (recall Fig. 9-4). Name the ROI "Brain" (or whatever you like).
- Set the initial lower and upper threshold to try to

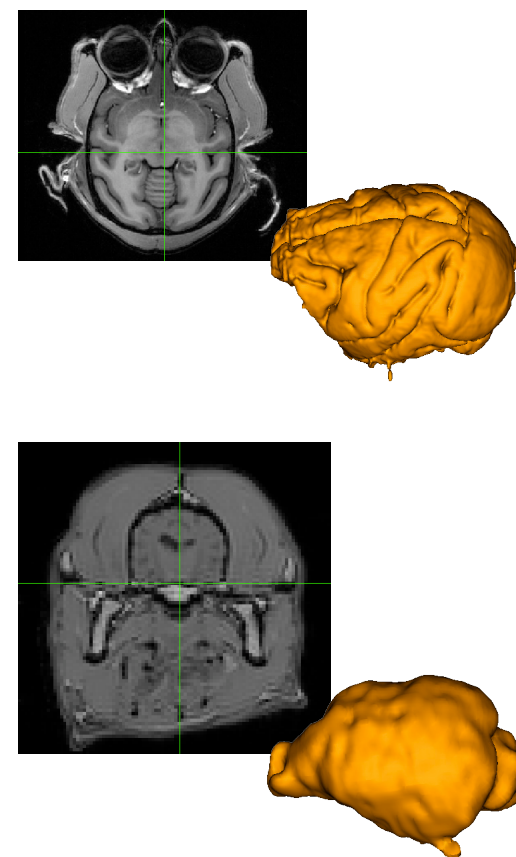

Fig. 9-7

Examples of 3D brain reconstruction using high contrast and high resolution and low contrast, low resolution data.

isolate the brain (see Fig. 9-8).

- Decide which orientation to work in: Move the cursor around the brain by clicking in the smaller 3 orthogonal views on the right side. The goal here is to decide which orientation (usually transverse or coronal) will be the best ones to isolate the brain with a minimum of “bleed”. Bleed is when unwanted structures are selected by the seed tool because they also lie between the lower and upper intensity thresholds used for the brain, and are connected to the brain (e.g. optic track). Look at the brain in the transverse and coronal views to try to decide which orientation will have the most slices in which the brain is well isolated. Your choice of orientation may also be dictated by how homogeneous your images are. If for example, the front of the brain is noticeably darker than the rest, then it will be easier to use coronal images to isolate the brain because each slice will be relatively more uniform than any transverse slice. No orientation will isolate the brain completely for all slices, but one might have more good slices than another. For example, in the transverse orientation, the optic nerves are sources of unwanted bleed, while in the coronal plane, the marrow of the skull may be a source of bleed (see Fig. 9-9).
- We will use the coronal orientation for this example (you may choose the transverse if you



Fig. 9-8

Typical threshold to isolate the brain from the surrounding tissue.

find it better for your data). You can start the process anywhere you wish. It may be more motivating to start on an easy slice in the middle where there will be no bleed. For example, start in the middle of the brain. Adjust the threshold to best isolate the brain.

- Select the seed tool, and drop a seed in the brain (see Fig. 9-9, right column).
- Verify that the seed fill covered all the brain. Otherwise, drop one or more seeds on the parts of the brain that were not selected.
- Click **Next Slice** to go to the next one. Verify that the whole brain was painted. If there was an unwanted bleed, then use the eraser and erase region tools to clean up the slice, or use **Undo**.
- Continue this process until you reach the end of the brain. Take note that occasionally the threshold that was selected at the start may not be suitable for all slices. If you find that as you move from slice to slice, the threshold seems to be less than optimal, click **Clear slice** and then **Clear seeds** to reset the slice. Adjust the threshold again, and drop new seeds using the seed tool. For example, Fig. 9-11 illustrates an example where the threshold used for the middle of the brain would encompass the eyes. By adjusting the upper and lower threshold, the eyes were segmented out without a lot of manual editing.

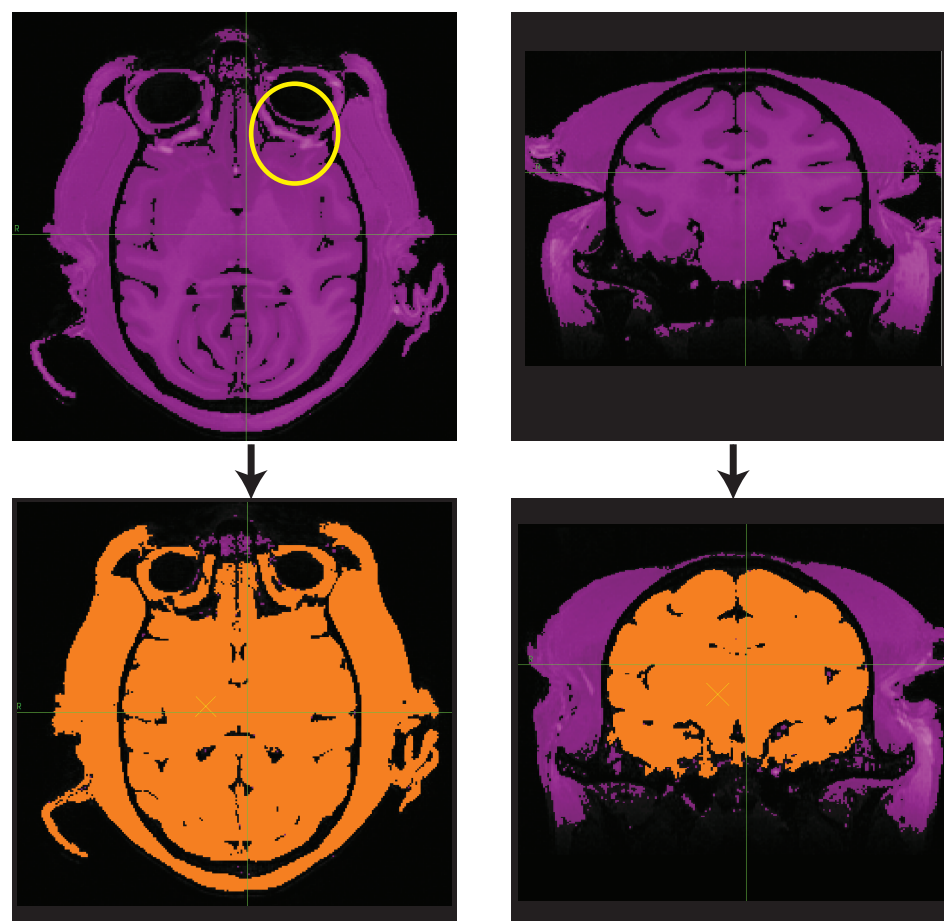

Fig. 9-9

Examples of how the selection of the orientation can have an impact on how much manual editing will be required. The left column illustrates how in this particular scan, the transverse slice has unwanted connections to the skin via the fatty tissue near the eye (yellow circle). The right column shows the brain being well delineated without manual editing.

- Once you reach the end, return to the middle (where you started), then work your way in the other direction until you complete painting the brain. Once complete, you can either create other ROIs (e.g. skull) or proceed to Chapter 10 to build a 3D reconstruction from the ROI.

### Segmenting the skull

Segmenting the skull is similar to segmenting the brain or other structures with a couple of practical exceptions. First, most MR images do not actually image the skull. In order to have a reasonable estimation of the skull shape, the signal void from the inner and outer table (inner and outer surface, with the marrow in between) is used. Second, the skull shape as defined by the signal void can include other non-skull sources of signal void, including air (sinuses) and signal drop off from image intensity inhomogeneity. These realities necessitate different strategies to efficiently segment the skull.

- Click **New ROI from Region Paint** to start the process.
- Name the object "Skull".
- Take a moment to explore the volume. First, lower the upper threshold to try to select the signal void that approximates the skull. Look at both the coronal and transverse orientations and decide which orientation will have the most enclosed sections, that is the least selected areas that "bleed" into other dark areas. You will likely select

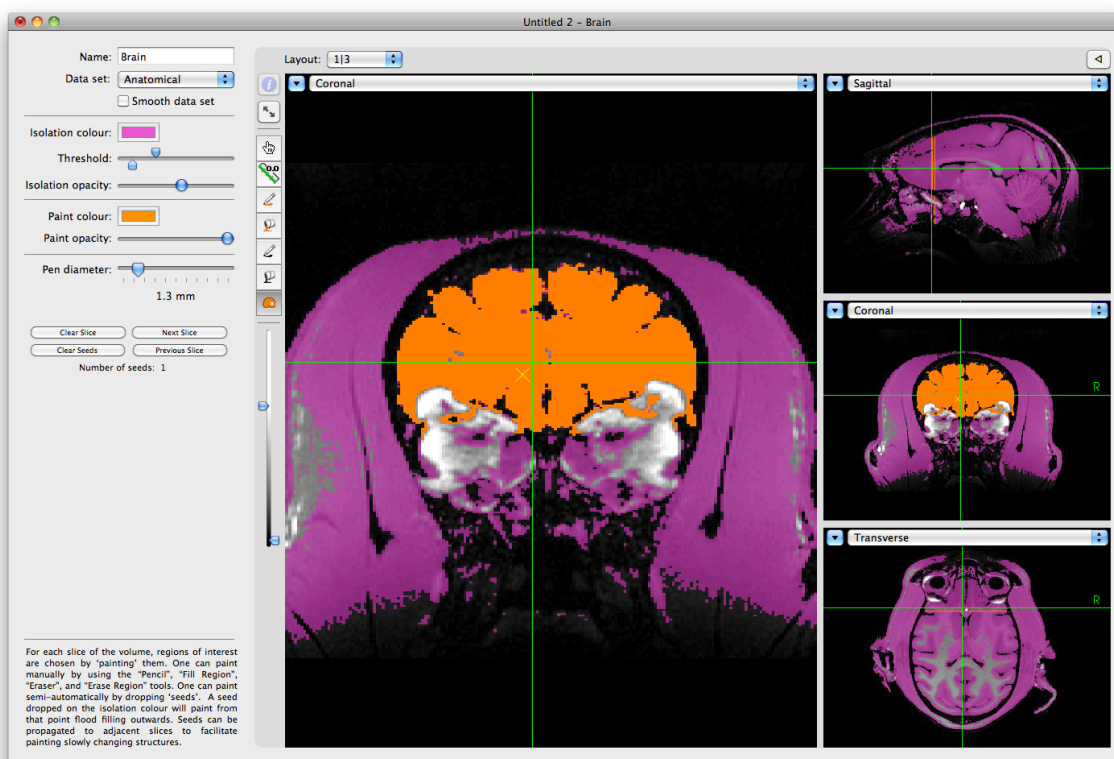

Fig. 9-10

**New setting of the threshold to exclude most of the bright regions around the eyes.**

the transverse orientation.

- Try selecting **Smooth data** set to see if that helps create a better selection. Keep in mind that you may improve the noisy areas, but also lose some of the areas where the bone is thin.
- You will likely be unable to find a perfect threshold for the entire skull. Try to break up the skull into a few zones, particularly zones that are naturally isolated from each other. For example, in the upper part of Fig. 9-11, the threshold was picked to isolate the lateral and posterior parts of the skull. The “cost” of this is that the anterior portion of the skull is poorly delineated due to image intensity inhomogeneity. This can be addressed by using a multiple pass strategy. Set the threshold that is optimized for the lateral and posterior part of the skull.
- Select the seed tool, and drop one or more seeds in the posterior and lateral parts of the skull.
- Click **Next slice** to proceed to segment the next slice.
- Continue until that region of the skull has been painted, making adjustments to the threshold as needed. Remember, you do not need to paint all the skull in this pass.
- Go back to the first slice that you started painting, click **Clear Seeds** to clear the seeds.
- Press **Previous slice** to move backwards to an

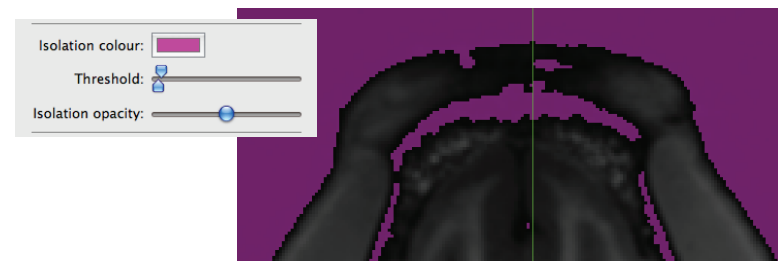
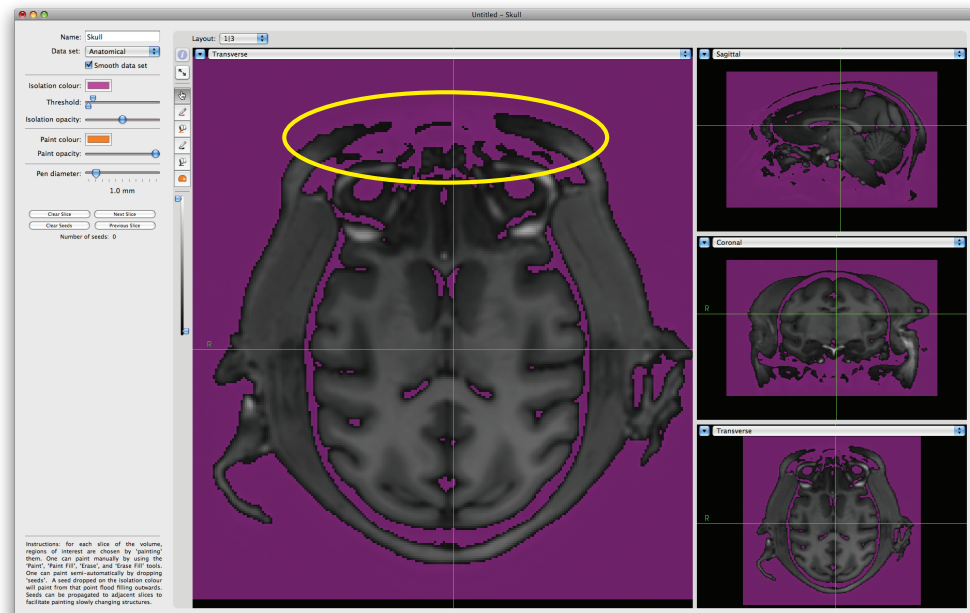

Fig. 9-11

**Thresholds for two different sections of the skull. The upper image shows the threshold optimized for the lateral and posterior regions of the skull, with an obvious problem with the anterior part of the skull. The lower part shows the threshold adjusted for the anterior part of the skull (the lateral and posterior regions would not be well delineated with this threshold).**

unpainted slice, and use the seed tool to begin painting that slice. Continue in that direction to complete the skull.

- Change the threshold to isolate the next section of skull, and proceed throughout the volume (clicking **Next slice** and **Previous step**) to paint that region.
- Repeat for all regions to paint.
- Close the window when complete.

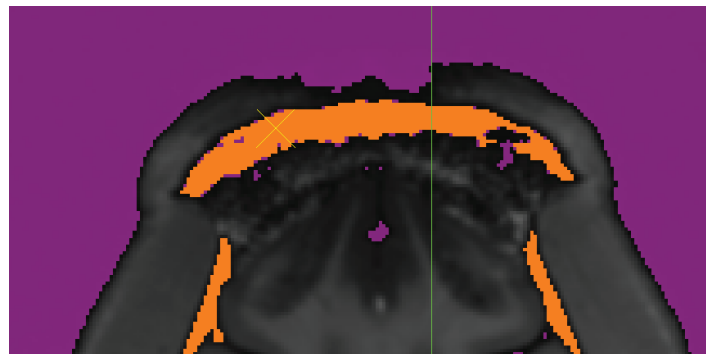

Fig. 9-12

Upper image shows the region painted using the threshold shown in the upper portion of Fig. 9-11. Lower image shows region painted by the adjusted threshold shown in the lower part of Fig. 9-11.



# Chapter 10: 3D Reconstruction

3D reconstruction is the operation of creating a 3D surface for the purposes of display. These 3D objects can be painted with a solid colour, or in the case of a curvilinear surface, the surface is painted with the values of the image voxels that intersect that surface. Brainsight currently supports several reconstruction methods: The automatic skin, automatic curvilinear and reconstructions derived from overlay data sets and ROIs. 3D surfaces generated from 3rd party software can also be imported and visualized.

Fig. 10-1

**3D Reconstruction Manager.**

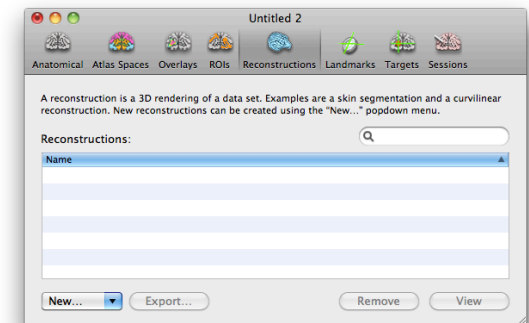

3D reconstructions are performed for many purposes. First, a skin reconstruction is performed to help in overall orientation. Second, a 3D brain reconstruction is performed to simplify target selection and provide a more intuitive view of the brain while manipulating your tools during surgery. Third, a 3D reconstruction of the skull may be helpful in planning and placing implants that are fixed to the skull. Creating a 3D reconstruction of the skull is also important for the registration of the animal to its scan with the laser registration procedure and the robotic arm (see Chapter 13). Finally, reconstructions from regions of interests or ROIs can create 3D representations of information that may be relevant to your particular procedure (e.g. functional activations, specific anatomical structures). The method of creating surfaces is essentially the same, however there are minor differences that warrant explanation here.

## PERFORMING A SKIN RECONSTRUCTION

- From the Reconstruction manager pane of the project window (see Fig. 10-1), click on **New...** and select **Skin**. An image view window will open.
- If needed, set the bounding box to encompass the whole head by dragging the boundaries with the mouse. You can use this box to try to exclude wrap-around artifacts, if they are present.
- Set the colour to your desired setting by clicking on the colour box, and selecting the colour using the palette that appears.
- If needed, adjust the threshold to isolate the head vs. the surrounding air (and MR noise) as much as possible (see Fig. 10-2).
- Click **Compute Skin**. After a moment, the skin object will appear in the top left view (see Fig. 10-3). Note that if you use large data sets (e.g. 512x512 pixels/slice), then this step may take a minute or more. If you notice it consistently takes longer than half a minute (and you see the spinning colour pinwheel), consider obtaining more RAM or upgrading your computer.
- If the results are not satisfactory, adjust the threshold and click **Compute Skin** again.
- Once the desired skin has been created, close the window by clicking the close button (top left button).

Fig. 10-2

Skin segmentation step with head properly cropped.

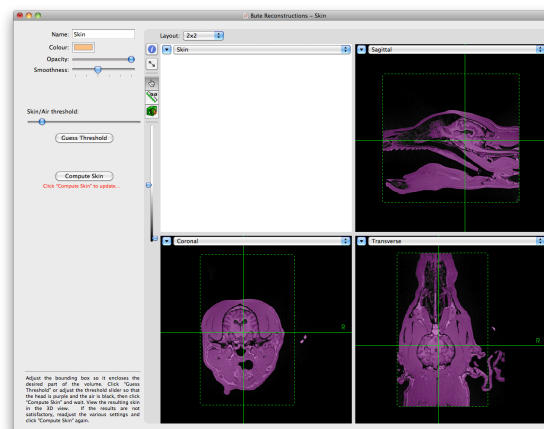
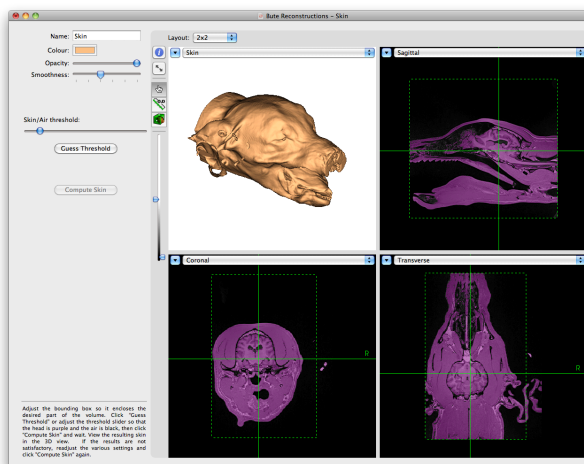

Fig. 10-3

Completed skin.



## CREATING A 3D RECONSTRUCTION FROM AN ROI (E.G. BRAIN AND SKULL)

If you created a region of interest (Chapter 9), then you can use this to create a 3D surface representation of that object. The most common ones are the brain and skull. Both use the same steps:

- Click **New...** and select **Surface from ROI** to open the surface generator window.
- Type in a name for the object in the name field.
- Select the ROI that you wish to use as the source of the 3D reconstruction from the popup menu.
- Click **Compute Surface**. After a moment, the 3D reconstruction will appear.
- If desired, set the colour of the 3D surface by clicking the colour box, and selecting a colour from the colour picker.

### Special notes for skull reconstructions

When reconstructing the skull, pay special attention to the smoothing value used. If you set the smoothing to none (see top of Fig. 10-4), the results will look rough as the edges of the voxels will be taken "literally" yielding a characteristic stairway pattern. When applying smoothing, the stair pattern is removed, but areas in the source ROI that were thin (commonly found in the temporal area of the skull ROI) were removed in the smoothing process. Try to find a middle ground that yields a reasonable looking skull with a minimum of thin area removal (middle of Fig. 10-5).

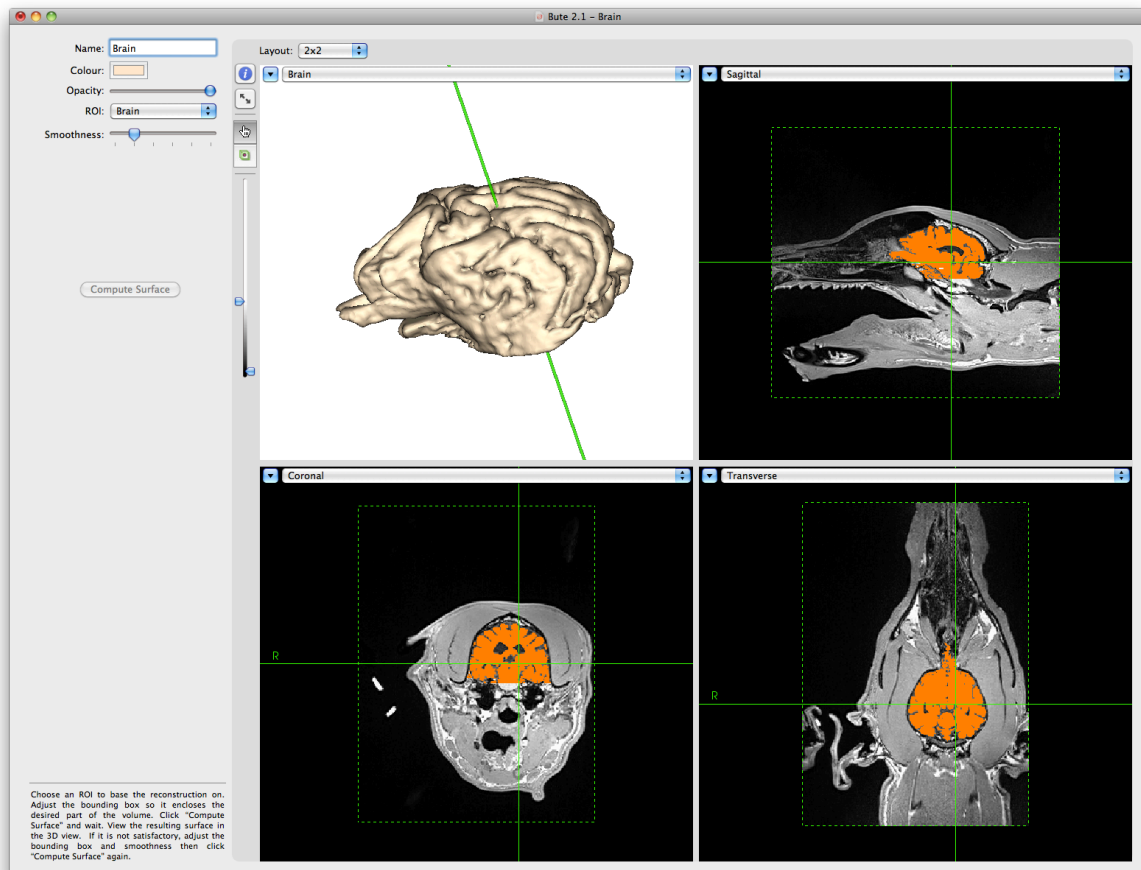

Fig. 10-4

3D reconstruction from ROI window showing brain reconstruction.

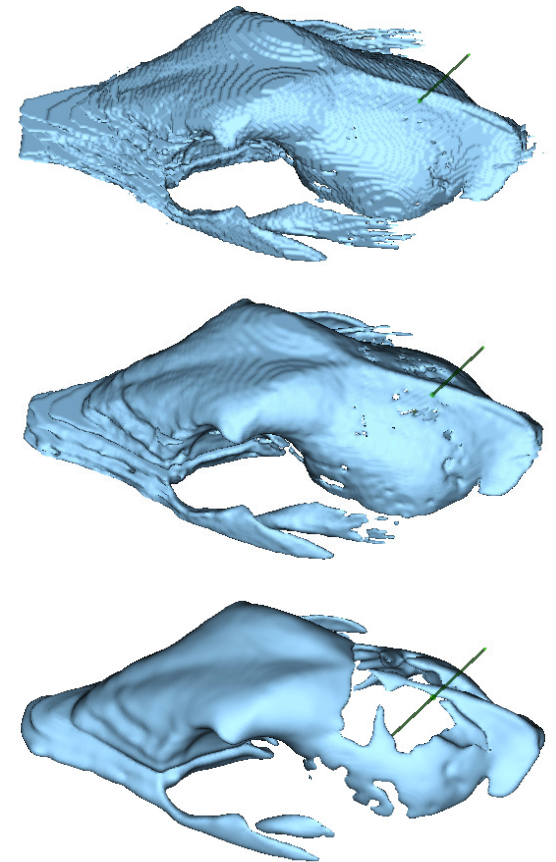

Fig. 10-5

Examples of the effect of smoothing on the 3D surface generation. Top: No smoothing shows the pixel edges. Middle: "a bit" of smoothing removes the pixel edges. Bottom: Maximum smoothing removes all trace of the voxel shape but also loses areas where the ROI was very thin (e.g. Skull wall).

## CREATING A CURVILINEAR RECONSTRUCTION OF THE FULL BRAIN

**Note: The Full Brain Curvilinear reconstruction tool was initially designed for human sized brains. We are actively working to perfect the process for the varying sizes and shapes encountered in the veterinary world. In the meantime, your results will vary, particularly with the automatic curvilinear reconstruction.**

In addition to the traditional surface rendered objects created in the previous section, Brainsight also provides a method called curvilinear reconstruction which is designed to provide you with a 3D representation of the entire cortical ribbon, by creating a representation that can be interactively peeled to different depths, much like peeling the layers of an onion.

To create a curvilinear reconstruction:

- Click **New...** and select **Full Brain Curvilinear**.
- The default settings are typical values. You can change them if you wish. Note that in contrast with Brainsight 1, the settings here are a bit different. Instead of start/stop depths and spacing, simply enter the end depth and spacing. (The start is now assumed to be 0 mm). Typical values are a stop depth of 10mm with a slice spacing of 1mm.
- Click **Compute Curvilinear** to generate the curvilinear surface. The process can take up to one minute depending on your computer.
- Once the brain has been generated, take note if the

shape is reasonably accurate. This is especially so for species whose brain shape differs greatly (other than in scale) to the overall shape of a human head. If your result is not even close to the proper shape, then follow the steps of the next section.

- If you previously loaded an fMRI overlay, you will also see it overlaid. Change the depth again to see where the peak occurs (see Fig. 10-5).
- Close the window by clicking on the close button at the top left of the window.

## IF THE FULL BRAIN CURVILINEAR RECONSTRUCTION DOES NOT WORK

The automatic curvilinear reconstruction is designed to work without requiring any user input. Occasionally

though, the algorithm will fail. Without going deep into the implementation of the algorithms, one of the causes of failure is an error in determining the approximate centre of the brain (which is the starting point for the algorithm). This can be corrected by adjusting the bounding box to delineate the brain from the rest of the head. This is particularly helpful in cases where the image acquisition is in the sagittal plane with a large field of view (so there is a lot of neck in the field of view). To adjust the starting point:

- Move the edges of the box until the brain is delineated (see Fig. 10-6).

Fig. 10-6

Curvilinear surface "peeled" to reveal fMRI peak.

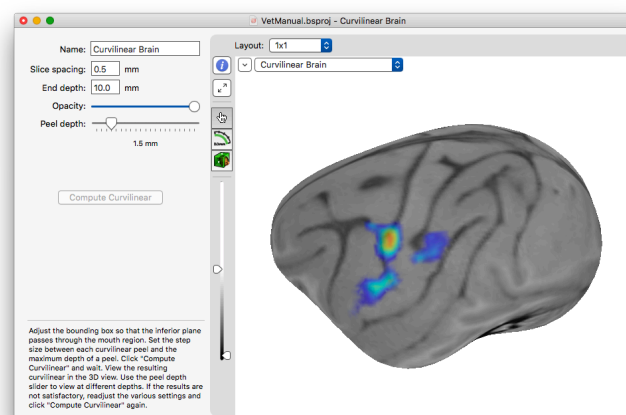

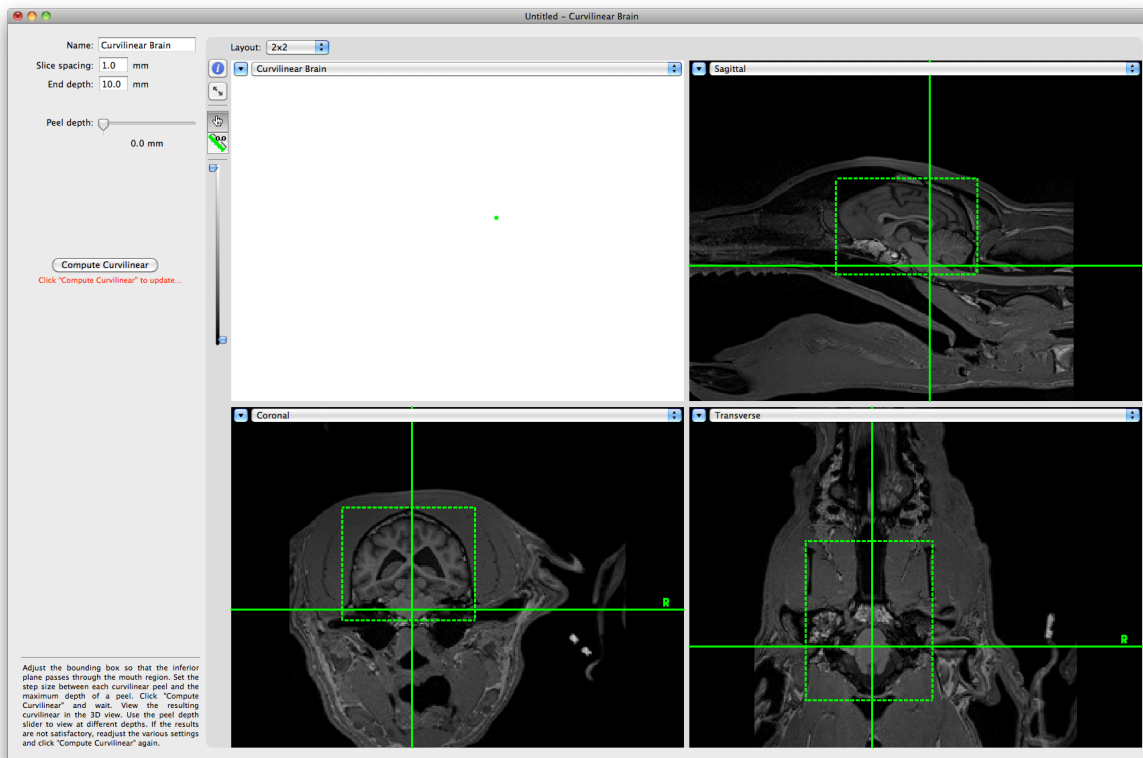

Fig. 10-7

Adjusting the crop box to help the automatic curvilinear algorithm.

- Click **Compute Surface** again and view the results.
- If this does not help, you can create a curvilinear from an ROI (see the next section).

### CREATING A CURVILINEAR SURFACE FROM AN ROI (FOR SMALLER STRUCTURES, OR MANUALLY PAINTED BRAINS)

In cases where the automatic curvilinear surface fails, or where a curvilinear surface on a subset of the brain (e.g. hemisphere, cerebellum) is desired, you can create a curvilinear reconstruction based on a region of interest. For example, you can use the region of interest tool to paint the whole brain.

To create a curvilinear surface based on an ROI:

- Use the ROI tool to segment your structure (see Chapter 9).
- Click **New...** and select **Curvilinear from ROI**.
- Select the ROI to use as the template to generate the 3D surface (if you have multiple ROIs).
- Click **Compute Curvilinear**, wait for the process to complete, and examine the results in the 3D view.
- If the surface appears too spherical (see top left of Fig. 10-7), then the smoothing setting was likely too high. Lower it by dragging the smoothness slider to the left a couple of notches, then click **Compute Curvilinear**. After a moment, the change will appear in the 3D view.

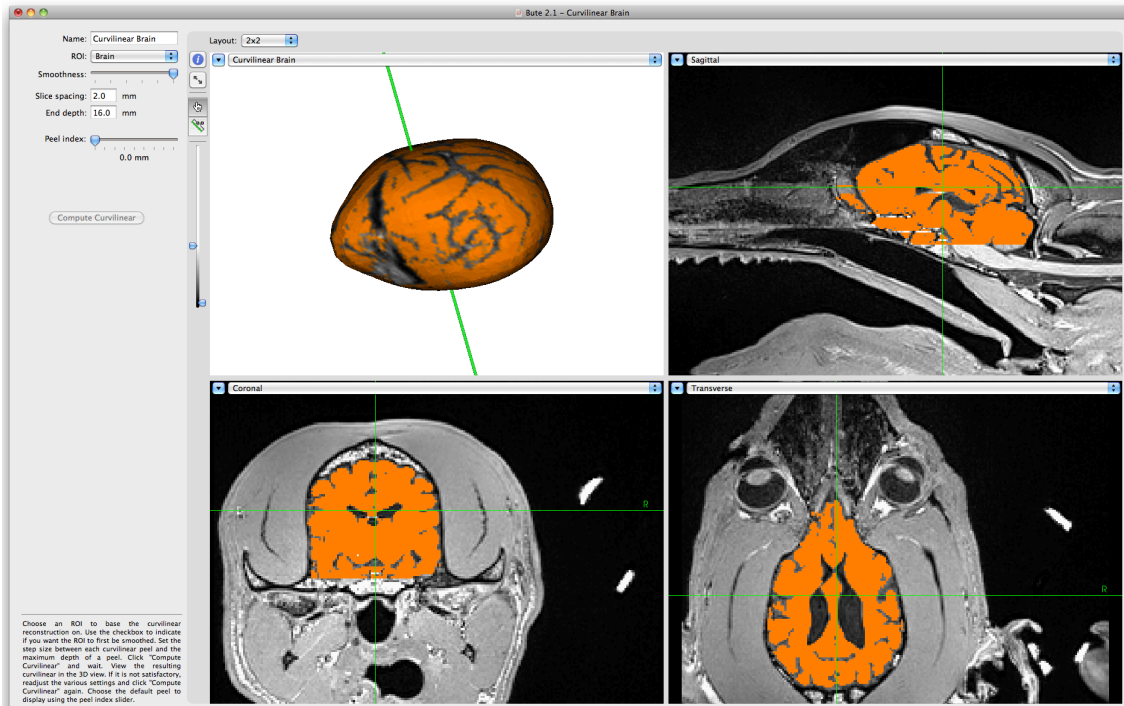

- If the surface was too rough (bottom left of Fig. 10-7), then increase the smoothing by a notch or two by moving the smoothness slider to the right and click **Compute Curvilinear** again.
- The expected result is shown on the right of Fig. 10-7.

### CREATING A 3D SURFACE FROM AN OVERLAY BY THRESHOLD

To create a 3D representation based on an overlay data set using threshold only (remember you can use the ROI tool to paint a region of an overlay in the same way as you can the anatomical data):

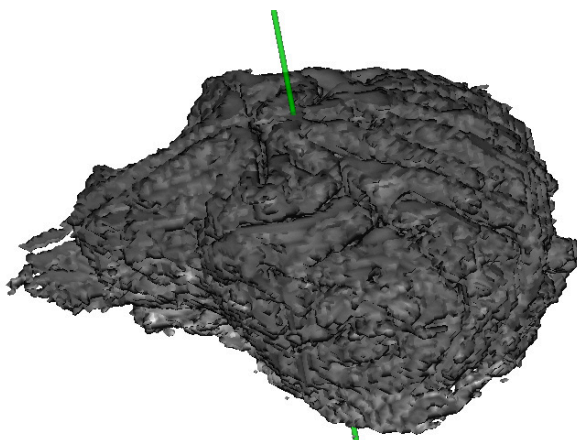
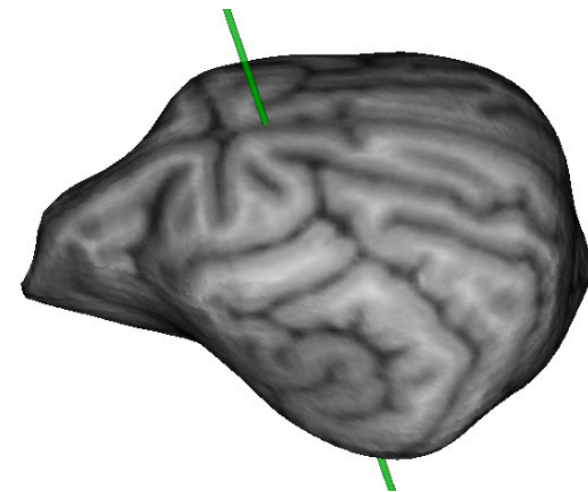

Fig. 10-8

ROI of the brain (above in orange) and the curvilinear surface derived from it (top left). Note that the surface appears too bulbous (arbitrary judgement). Adjusting the smoothness slider to none results in a bumpy surface (left). Adjusting the smoothness to something in between often results in a good surface (right).



- Click **New...**, then select **Surface from Overlay** to open the surface creation window.
- Select the overlay to generate the 3D surface from (if you have multiple overlays).
- Set the lower and upper thresholds to the desired value to delineate the desired intensity range.

If you cannot isolate your structure solely using an intensity range, cancel this process by closing the window (do not save the surface) and use the ROI tool to delineate your structure and see the next section on creating a surface from ROI.

- Click **Compute Surface**, wait for the process to complete, and view the results in the 3D view.
- Verify that the surface is acceptable. Change the threshold or smoothness parameter if needed and click **Compute Surface** to update it.

### IMPORTING 3D SURFACES FROM OTHER SOFTWARE

Brainsight can import surfaces saved in Polygon (.ply), Stereolithography (.stl) format and AutoCAD™ DXF format. Note that DXF files must be in text format, and only 3D polygonal objects will be read. It is important that the coordinate system of the mesh be in the anatomical image's Brainsight coordinate system. Otherwise, the location of the objects will be incorrect. To import a surface:

- Click **New...** and select **Import from File...**

- Select your surface file from the file selection dialog and click **Open**.

Brainsight 1.7 users can take advantage of this by using the STL export feature in 1.7 to export a surface and import it into Brainsight 2.

Fig. 10-9

Screenshot of the surface from overlay function.

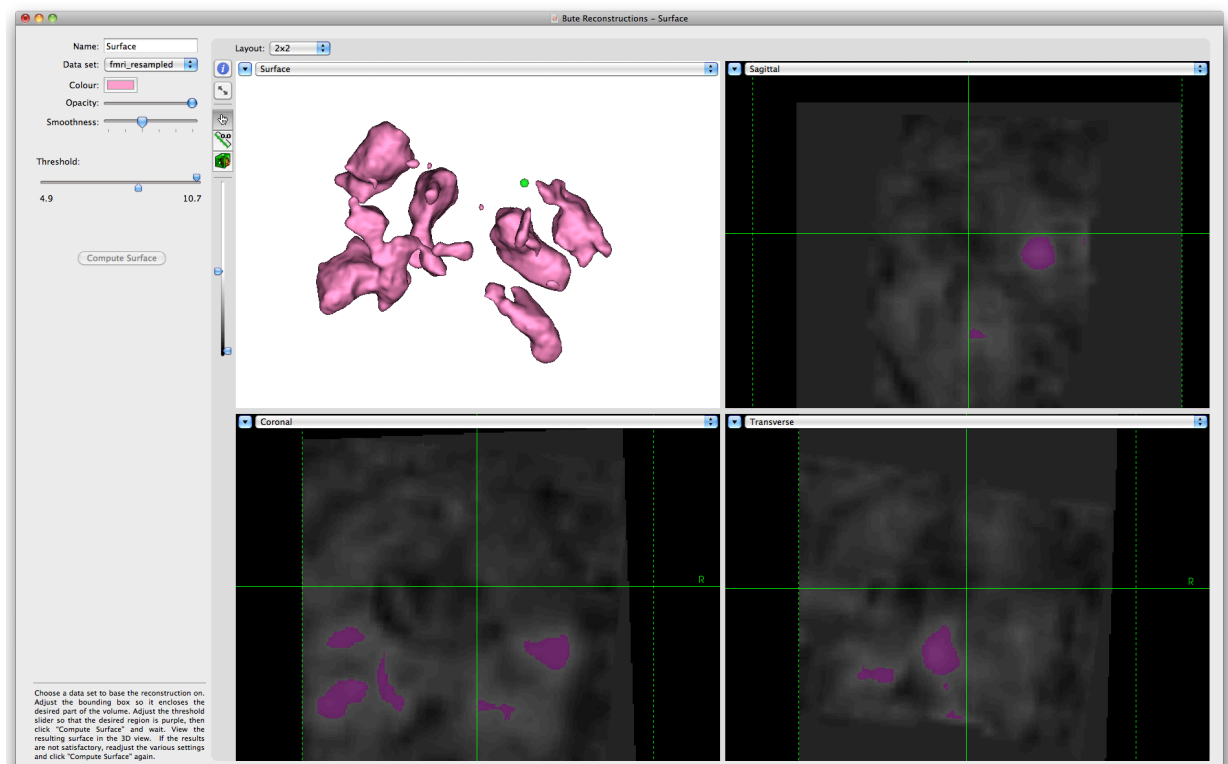

### EXPORTING 3D SURFACES

In many applications, it might be useful to note that any 3D surface created (except curvilinear surfaces) can be exported as AutoCAD™ drawing interchange format (DXF), Polygon (PLY) as well as in stereolithography (STL) file formats.

#### To export a 3D surface:

- Select it from the list of 3D surfaces shown in the reconstruction manager window.
- Click **Export...**
- Select the file format to use from the format popup menu, enter a file name, navigate to the desired folder, and press **Save**.

Using a “3D printer”, we have been able to construct replicas of segmented objects including the skull. This may be useful for surgical training or planning complex surgeries where having a replica of the actual subject may be useful. Contact Rogue Research for more details.



# Chapter 11: Selecting Registration Landmarks for Vet Robot

As explained earlier, the subject is co-registered to the images at the start of a surgical session. This is accomplished by identifying two landmarks on the images and on the subject.

This chapter describes how to identify landmarks on the images.

## INTRODUCTION

Good anatomical landmarks must abide by a few rules. First, they must be non-ambiguous, so a point in the middle of the forehead, for example, would not be good. They also have to be in the same location during the surgical session (with respect to the skull) as they were during the scan. That means they have to be rigid, so soft tissue would not be good.

We do not use our unique fiducial marker system with the Vet Robot, but landmark points on the skull.

## RECORDING THE LANDMARKS

It is often helpful to have already performed a 3D reconstruction of the skull, making it easier to locate anatomical landmarks in the scan.

To record the landmarks:

- Click **Landmarks** in the project window. The landmarks manager pane will display any landmarks created earlier, otherwise it will show an empty list (see Fig. 11-1).
- Click **Configure Landmarks...** to open the landmarks window (see Fig. 11-2).
- If you have created a 3D skull reconstruction, select **Skull and all Landmarks** from the Layout control popup menu in the view that is currently showing a 3D representation of the 3 orthogonal slices. The slices will be replaced by the skull (see Fig. 11-3).
- Rotate the 3D skull until you have a good view of

the landmarks. The key will be to identify them in a logical order (e.g. anterior to posterior) to prevent confusion later.

- When performing a registration of the animal in surgery using the laser, it is important to first identify 2 landmarks on the skull in order to aid the software in identifying the area that needs to be co-registered to the 3D skull surface reconstruction. These two landmarks should be carefully placed on the bone, such that the green crosshair ball in the 3D window is half inside the bone and half outside (see Fig. 11-4).
- Adjust the AP angle slider (the sliders are on the right of the window) until the landmark looks horizontal along the horizontal green line in the inline view.

Fig. 11-1

**Landmark entry manager.**

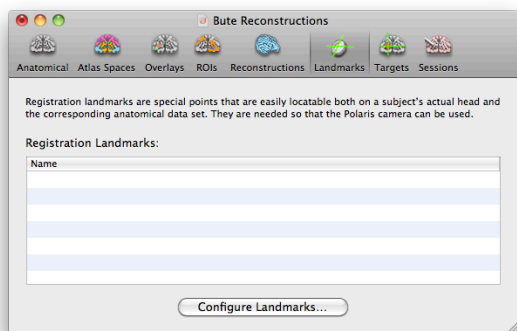
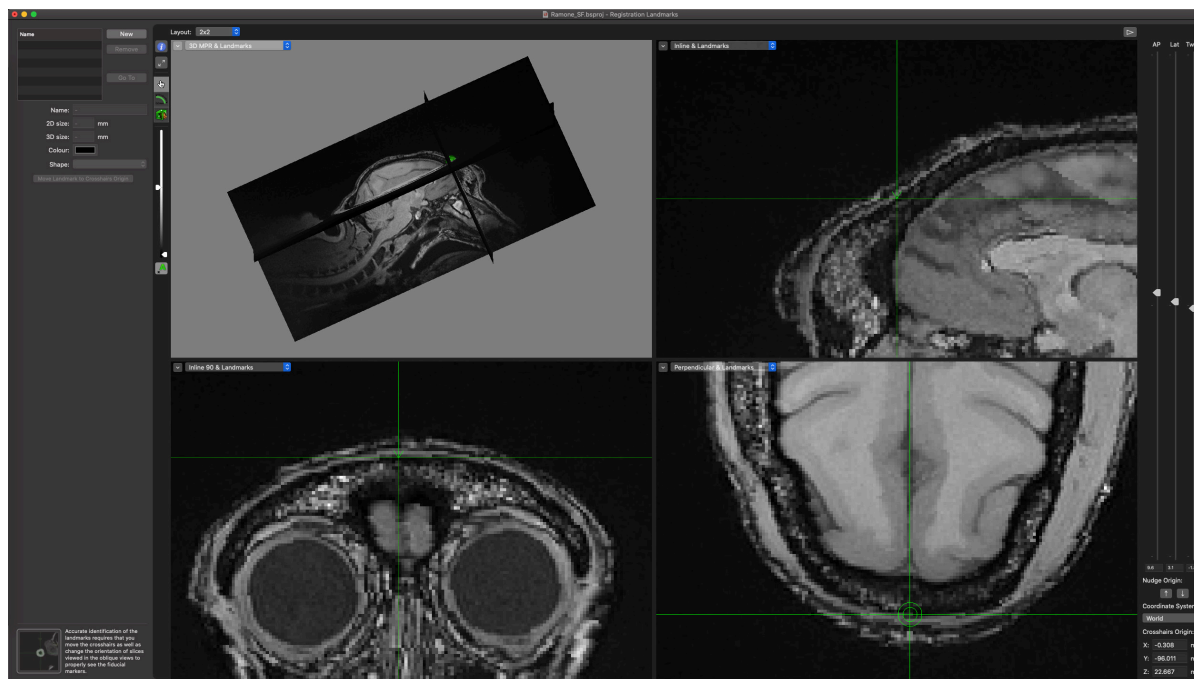

Fig. 11-2

**Landmark identification window.**



- Adjust the Lat slider so that the landmark looks horizontal along the horizontal green bar in the inline-90 view.
- Place the mouse over the perpendicular view. While keeping the mouse over the perpendicular view, roll the mouse scroll wheel to move the perpendicular slice up/down until the green cursor ball is half inside the skull and halfway below. This ensures that your point is on the skull.
- Once you are satisfied that the cursorball is cut in half on the skull, then click **New** to record the location.
- Note that the name field is highlighted so you can enter text that will overwrite the default name (default name is "landmark"). You can use "Landmark1" or a similar name.
- If desired, you can change the colour, size or shape of the recorded landmark. For clarity, we recommend leaving it as is unless you have a reason to change it.
- Repeat for the second landmark.
- Once the two landmarks have been recorded, close the window.

## MANUAL REGISTRATION

In some cases, it is not possible to carry out a registration on the animal's skull using the laser registration step due

Fig. 11-3

Landmarks window showing 3D skull.

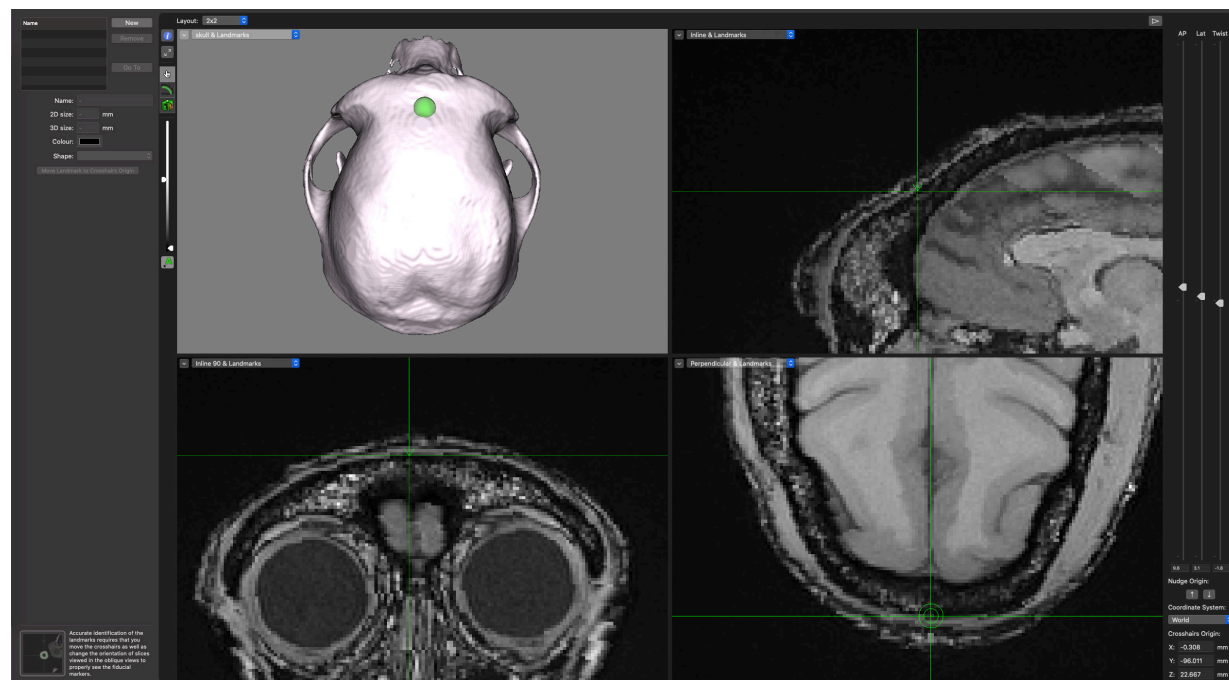

to the fact that there is insufficient bone surface to generate a good point cloud or perhaps there are too many implants already on the animal's head. In this case four manual points can be selected in the MRI or CT scan 3D reconstruction. These same, homologous, points are then identified in surgery using the computer mouse to select

the points in both camera A and B. Please note that selecting points that are somewhat spread out across the surface area will lead to a better co-registration if possible (i.e. left side, right side, anterior and posterior; see Fig. 11-5).

Fig. 11-4

Click on the 3D representation of the skull to help with orientation of the cursor.

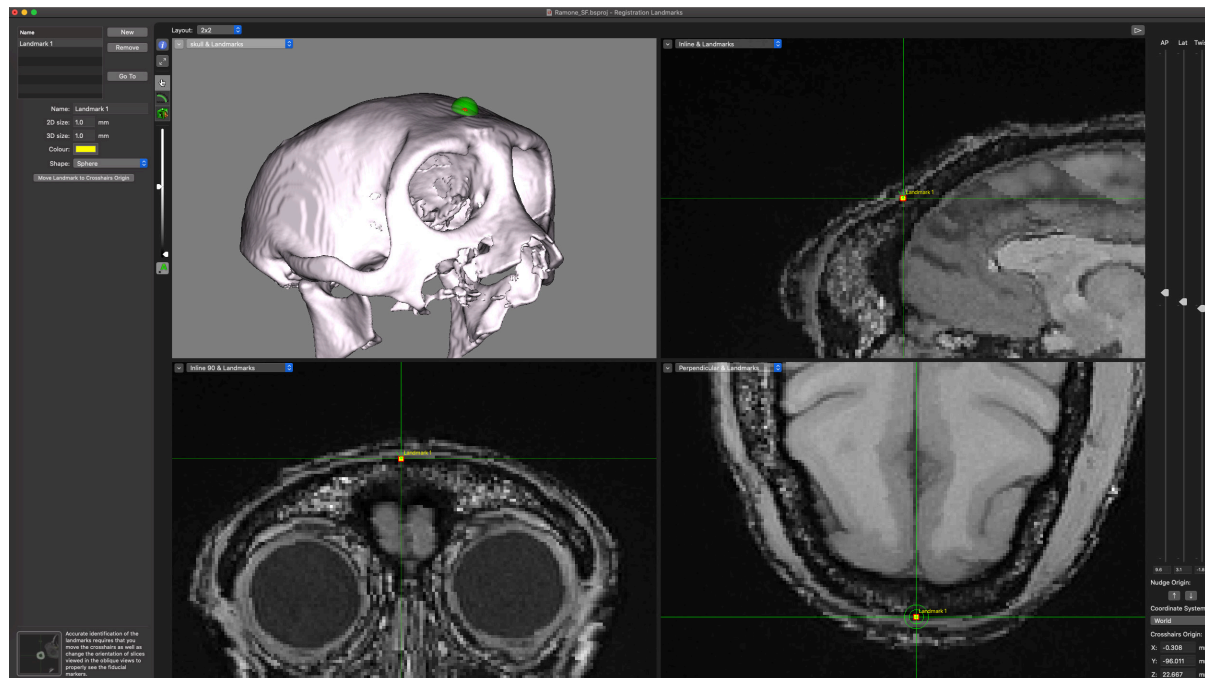
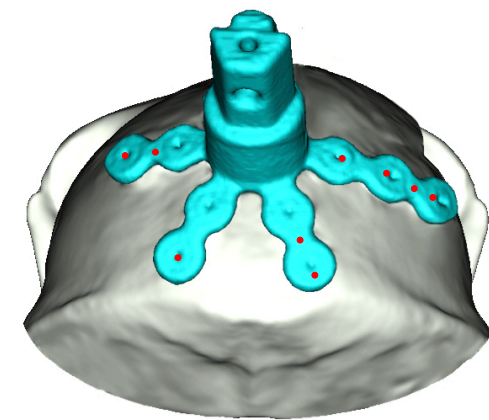

Fig. 11-5

Manual registration. Acceptable landmarks are identified in red.



# Chapter 12: Selecting Targets for Surgery

The process of selecting your target is very similar to selecting the landmarks, except for the nature of the targets themselves. How you pick the target depends on your protocol. You can select a target anatomically, using atlas coordinates, or by picking them based on a functional overlay.

You can define the type of target. It can be a simple point inside the brain, a point with an approach angle, or even a grid for electrophysiology applications. If you are using our microsurgical robot, the targets need to be trajectory-based.

To start the process, click **Targets** in the project window to bring up the target manager pane (see Fig. 12-1) and then click **Configure Targets...** to open the targeting window.

Fig. 12-1

**Targets manager.**

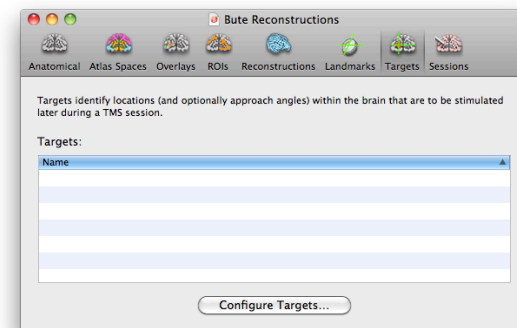

Fig. 12-2 shows a typical targeting window. In addition to the typical image views and list of targets on the left, there are additional controls on the right. The image views are set by default to the traditional transverse, coronal, and sagittal as well as the oblique inline, and inline-90 views. Finally, the 3D curvilinear surface is shown. As with all view windows, you can change these values as you like. If you are planning an implant, it can be helpful to swap one of the traditional 2D slices for a 3D skull (if one was created). The angle adjustment tool enables you to change the “approach” angles of the

# Target Positioning Tool

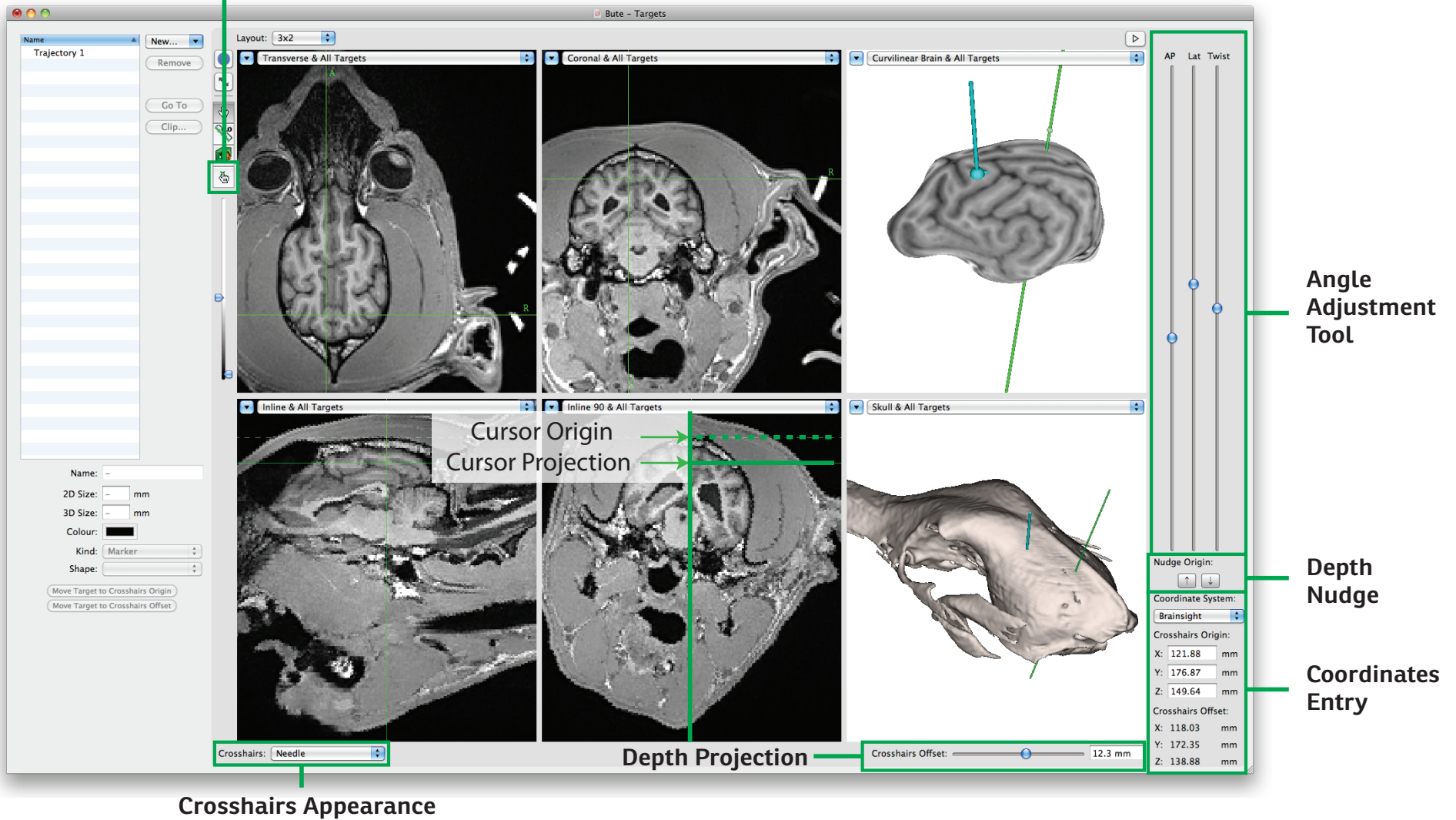

Fig. 12-2

Typical targeting window.

The targeting window introduces a few new tools and important concepts (in addition to those described in Fig. 12-2).

The **Target positioning tool** is used to adjust a target origin location. When this tool is selected, the current target (as defined by the one selected in the target list) becomes linked to the cursor. Any change to the cursor will immediately change the location and orientation of the target. This makes it easy to tweak the location and orientation of a target. Be sure to deactivate the tool by selecting the cursor tool when finished with the target, or you will end up moving your target accidentally.

The **Angle adjustment tool** provides a series of slider controls to alter the approach angles of a target.

The **Crosshairs origin** can be thought of as the location (and orientation) “of interest”. Usually, this is the location of the crosshairs. You can however, using the **Depth projection** slider, add a temporary offset in the direction along the crosshairs’ trajectory (e.g. along the vertical line in the inline and inline-90 planes). Think of this as a “what if” tool to interactively explore the trajectory of the tool. When you click on the images to move the cursor, the click location becomes the origin (this might take some getting used to).

The **Coordinates entry tool** allows you to select the desired coordinate system to view and set the location of the cursor origin using xyz coordinates. When using the depth projection slider, the offset coordinate is also shown.

The **Depth nudge tool** is used to nudge the location of the origin up and down along the trajectory. Think of it as a permanent version of the depth projection slider. When placing an implant on part of the skull, you can use this (when using the target positioning tool) to nudge the implant into or out of the bone.

The **Crosshairs** popup menu allows you to select the appearance of the cursor in the 3D view among built-in preset appearances, or by selecting **Other...**, you can select a CAD file to use a custom representation or to simulate an implant.

cursor origin, which is particularly helpful when defining trajectory targets and chambers.

There are three classes of targets that can be defined. Marker targets ( $x, y, z$  only), trajectory targets ( $x, y, z$  and orientation), or chambers (both round and rectangular).

### ANATOMICAL TARGETS (VISUALLY IDENTIFIED)

There are two ways to look at targeting. Either define an entry point, then pivot from that entry point to see if a good angle to target can be found; or take a point within the brain and from that point, look for a good entry point and approach angle by pivoting the approach angles around the target (see Fig. 12-3). To define a target by

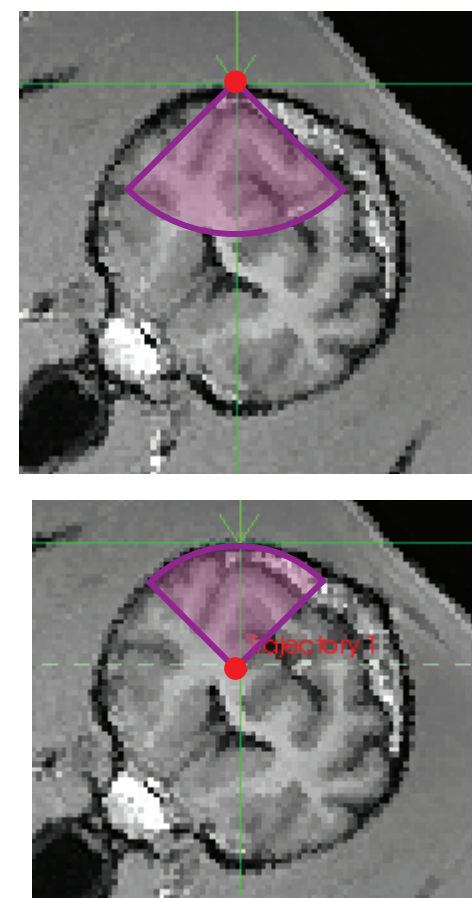

Fig. 12-3

**Different methods of defining the target. Top: Picking a fixed entry point and sweeping from that point into the brain volume. Below: Defining a target within the brain, and sweeping from that point to find a good entry point and path.**

defining a brain target:

- Move the cursor origin to the desired location on the brain, using whichever image views are most helpful.
- Note that if you click on the 3D brain (or 3D skin or skull), the orientation is set using the curvature of the surface to show a “reasonable” approach angle. Use the angle adjustment slider controls to tweak the approach angles.
- You can verify the trajectory by simulating the needle’s path using the offset slider tool. By sliding the offset slider back and forth, an offset in the direction of the trajectory is added or subtracted from the cursor’s origin location (this does not change the origin itself, but a “cursor projection” will move away from the origin).
- Click **New...**, and select the type of target to create (Marker or Trajectory) and whether to create it at the crosshairs origin, or the projected location. The target’s origin (x,y,z location and approach angles) will be set to the current origin of the cursor or the offset location, depending on which type you decided to create.
- Enter a name for the target, and select the size, colour, and shape to suit your needs. If you have a CAD file that describes your implant, then click **Crosshairs->Other...** and select your CAD file when the file selector sheet appears.
- If needed, tweak the origin location of the target by

selecting the **Target positioning tool**, and moving the cursor. As the cursor moves, the currently selected (active) target’s origin will constantly update to the cursor’s origin. Note that if you have a non zero offset (as set by the offset slider), then the origin will be set to the location of the mouse click, and the current offset value will be used to project the cursor as before (this can look a little jarring, and can be eliminated by setting the offset slider to 0).

- If you are implanting something, use the tweak origin to tweak the implant into or out of the bone. The sensitivity of the tweak tool is set to the current “slice increment size” preference value.

### COORDINATE BASED TARGET

If you have derived a target in either Brainsight’s coordinate space (see Fig. 12-2, bottom right) or the anatomical MRI’s World coordinate space (e.g. scanner coordinates found in DICOM images or an atlas that it is registered to), you can move the cursor origin to that location by:

- Choose the desired coordinate system by clicking on the popup menu button in the coordinates entry area of the window, and selecting it from the list.
- Enter the coordinates of the target in the X, Y, and Z entry fields.
- Verify visually (if possible) that the location appears correct anatomically.

- If you wish to record a trajectory-based target, adjust the approach angles using the angle sliders.
- Click **New...** and select the type of target to create (Marker or Trajectory) from origin. The target’s origin (x,y,z location and approach angles) will be set to the current origin of the cursor (which was set by the coordinates typed in earlier).

### fMRI BASED TARGET

Functional based targets are similar to anatomical targets in that you create the target by clicking on the images and recording the location, however the images include a functional overlay.

- If it is not already being displayed, display the functional data by opening the inspector and enable your overlay.
- Follow the steps outlined in the “Anatomical Targets” section to create and adjust your target.

### USING CHAMBERS AND GRIDS

Recording chambers (also referred to here as wells) can be used in Brainsight as receptacles for grids. Grids are considered an insert into the chamber that holds a series of parallel electrode guides. The chamber’s position and orientation are defined by the trajectory that goes through the center of the chamber.

Even if not using a physical grid during electrophysiology, sometimes it is helpful to place a grid in Brainsight



to create a coordinate system (x, y) for the recording chamber.

Note: Grids here should not be confused with grids in the non-surgical version of Brainsight where they are an array of markers or trajectories to create a series of targets on the scalp or head.

### Defining grids

In electrophysiology applications, it is common practice to fix a chamber on the skull, then decide after, from among potentially several grids that fit the chamber, which one will guide the needle to the correct location. Brainsight replicates this concept with a database manager for grids. Before being able to use a grid, one or more of them need to be created within this database.

To define a grid:

- Select **Window->Chamber Grids** to open the grid manager screen (see Fig. 12-4).
- Click **New Grid** to create a new grid. Otherwise, select an existing grid in the list to change the grid's properties or click **Remove** to delete the grid.
- Name the grid by editing the text in the **Name** field.
- Set the grid shape (round or square) using the shape buttons (Rectangular or Circular).
- Set the grid height (in mm). This will be used to draw a 3D representation of the grid.
- Set the x & y node spacing, and the number of nodes in the x & y directions. Note that in the case

of a circular grid, only the nodes that fit within the diameter of the circle will be used (as defined by the node spacing and node count).

- Once you have finished editing your grids, close the window.

### Defining a chamber target

Defining a chamber is similar to defining a trajectory. In fact, you can place a trajectory first, and change the target style from trajectory to chamber at any time. You will often be evaluating the location by simulating grids and using the grid's controls to move the needle

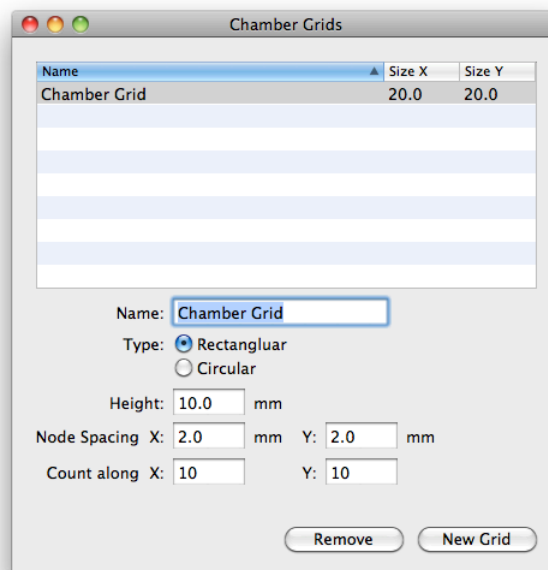

Fig. 12-4

Grid Manager Window.

from grid node to grid node, then use the offset slider to evaluate that path. One key concept to keep in mind is that when placing the chamber, you are setting the chamber's origin (same concept as for the trajectory) and the grid controls will be projecting parallel tracks from the chamber's origin for display, but the origin itself remains until you move the chamber by clicking on the images again.

Usually, it is best to use a 3D skull reconstruction to place the chamber as it will best approximate what you will encounter in surgery during the placement of a recording chamber:

- If you have a 3D reconstruction of the skull, select it in one of the view windows. It is also helpful to display the 3D brain (curvilinear or "classic 3D"), inline, inline-90 and perpendicular views to evaluate the orientation of the chamber (see Fig. 12-5).
- Click on the skull at the proposed location for the chamber to set its origin location. Note that the curvature of the skull at that location will set the initial angles of the chamber. Use the **depth nudge up/down** buttons to move the chamber's origin location into or out of the bone.
- Adjust the orientation using the AP and Lat sliders on the right.
- You can use the depth offset slider to project the perpendicular plane into the brain to review the origin's trajectory into the brain (the trajectory of the

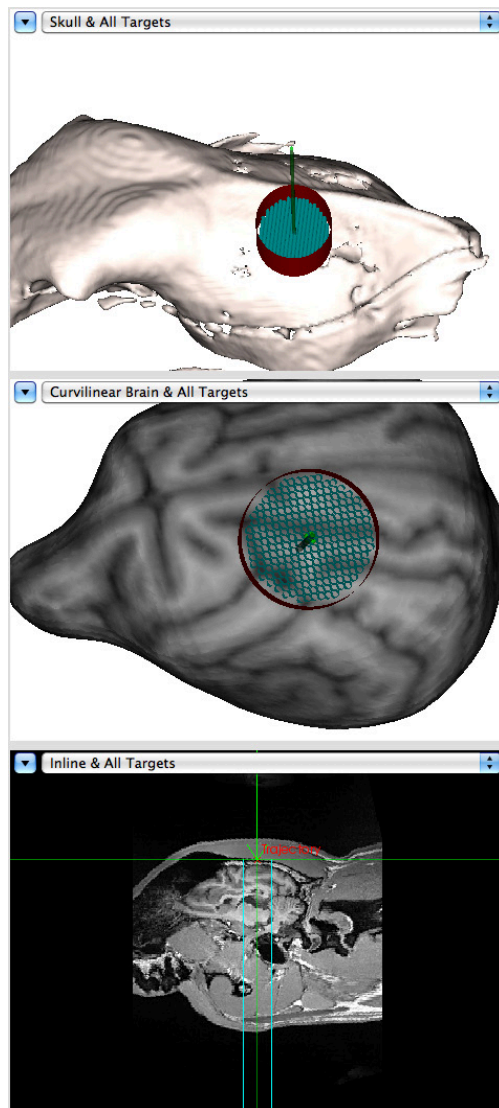

central axis of the chamber).

- Once you are satisfied with the position and orientation (you can still change it later), create a new chamber target by clicking **new->round chamber** or **new->rectangular chamber**.
- Note that the chamber is displayed as a thin-walled cylinder or box in the 3D view. If you have a 3D CAD drawing of the chamber, you can select **Crosshairs->Other...** in the Chamber controls pane and select your CAD file from the file dialog. Once loaded, it will be added as one of the shape options in the popup menu (see note regarding requirements of the DXF file format). See Fig. 12-6 for an example of a CAD derived chamber well.

#### Reviewing potential tracks

Once you have placed the chamber and associated a grid to it, you can use the grid controls to review individual needle tracks.

- Make sure the chamber target is the current target by selecting it from the target list (if it is not already the current one).
- Associate a grid to the chamber by selecting it from the **Chamber grid:** popup menu. The grid controls appear on the bottom left of the window (see Fig. 12-1, and see Fig. 12-7 for close-up of the controls).

Fig. 12-5

Example of a chamber displayed on the skull, curvilinear brain and the inline trajectory views.

#### Note using CAD files

Brainsight accepts the importation of 3D CAD files using the AutoCAD™ DXF and STL file formats, with a few restrictions:

- The DXF file must be in TEXT format (NOT binary).
- The only supported geometry is 3D polygons. You will likely have to convert most objects to 3D polygons before saving a DXF file.
- Early versions of DXF files may lack consistent support for colouring objects. A commonly used work-around is to use line thickness of the polygons to denote an intended colour. Assign a distinct line width to objects with distinct colours in your CAD software before exporting the DXF file and Brainsight will use them to assign a colour.
- The orientation of the object in the drawing must have the origin of the object's bottom middle, with the z axis pointing up. When the object is used when you click on the skull, the origin of the object as defined by the CAD file will be placed at the location of the cursor.

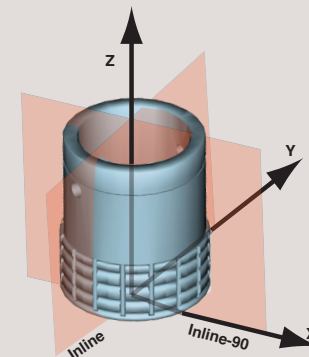

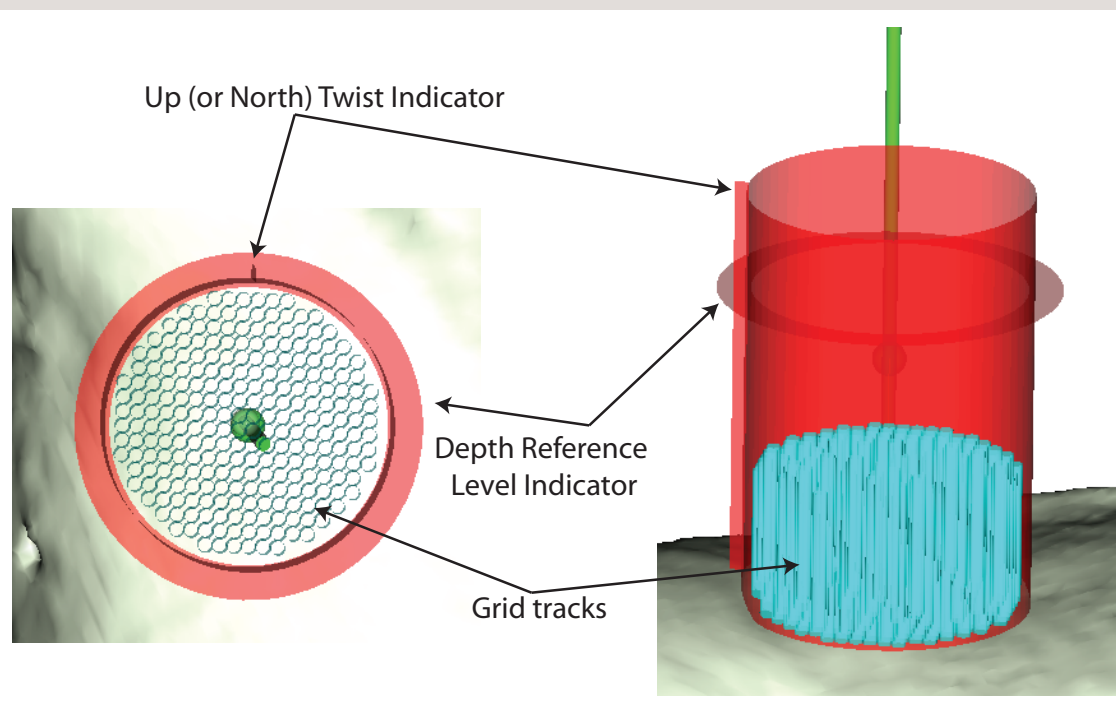

#### Note using grids and chambers

Using a virtual grid requires some terms of reference to allow you to transfer the information derived from the virtual grid to the real grid. The position and orientation of the chamber are set by you in Brainsight, either virtually (as in this planning stage) and “placed” in reality during surgery. In order to reach the same targets, points of reference for depth and twist rotation may be used.

- The twist is indicated by the north tab indicator. You should use a similar indicator on the actual chamber and grid to ensure that they are aligned.
- The true depth zero of any implant in Brainsight is defined as the bottom of the object (e.g. the bottom of the chamber, where it touches the skull). It may be useful to define other depth reference points that are verifiable when using the grid. For example,

the top of the grid, the top of the chamber wall, or even the dura may be a useful depth reference. This allows you to measure the depth to target from that reference point. The reference zero must be set by entering an offset from the true zero in the **Zero Reference** field (see Fig. 12-7). The zero reference is shown by the circular indicator on the chamber. Its position moves up/down depending on the value entered in the field.

- The grid tracks are also shown in the 3D display of the chamber when a grid is defined.

- Move to individual needle tracks using the Active Guide arrows to step in the horizontal and vertical directions. Use the offset slider to project the track into the brain. Note that this changes the cursor location and direction but not the origin location of the chamber itself..

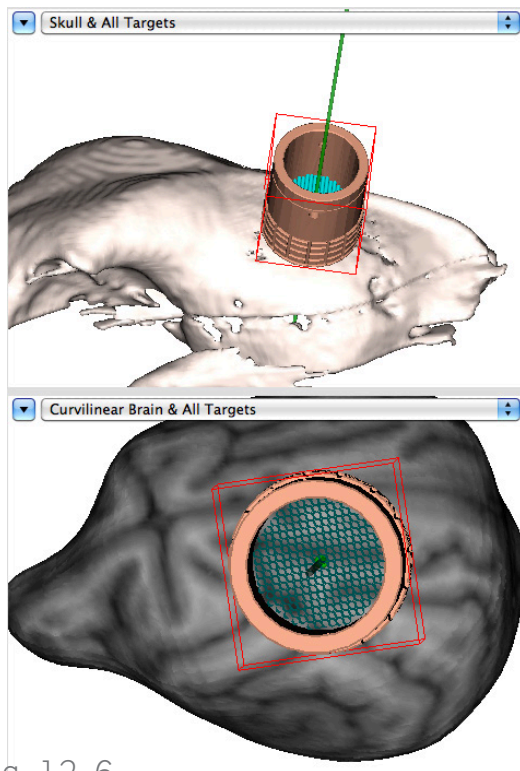

Fig. 12-6

Image showing a chamber well derived from a CAD file.

- As with the Trajectory or Marker, you can use the target positioning tool to interactively move the chamber. Remember that moving the chamber by clicking on the image views moves the chamber's origin, and if you have an offset set in the offset slider, the origin will include that offset (usually, it is easier to place the offset to 0 before moving the chamber).
- Continue to experiment with the grid tools and chamber location until you are satisfied that the location of the chamber is acceptable.

#### Defining special targets

In addition to traditional targets as explained above, you can use Brainsight to plan out every detail of your surgery, right down to screw placement. For example, if you have a 3D CAD file representing your surgical screws, you can create a series of trajectory style targets around your implant, and display them as screws by selecting their CAD file as the target's shape.

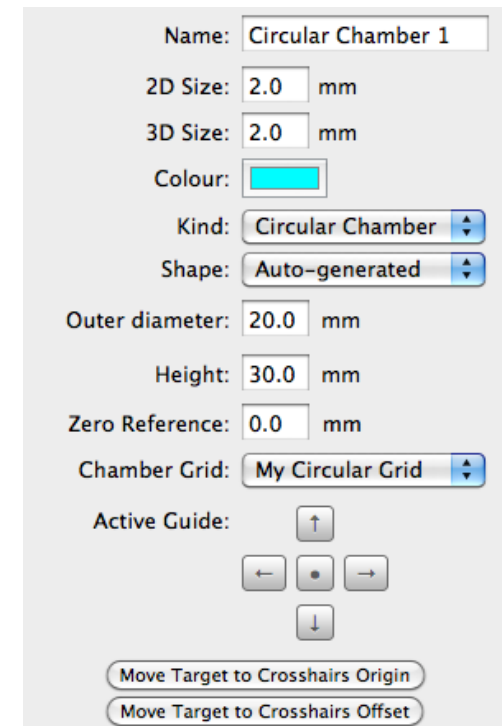
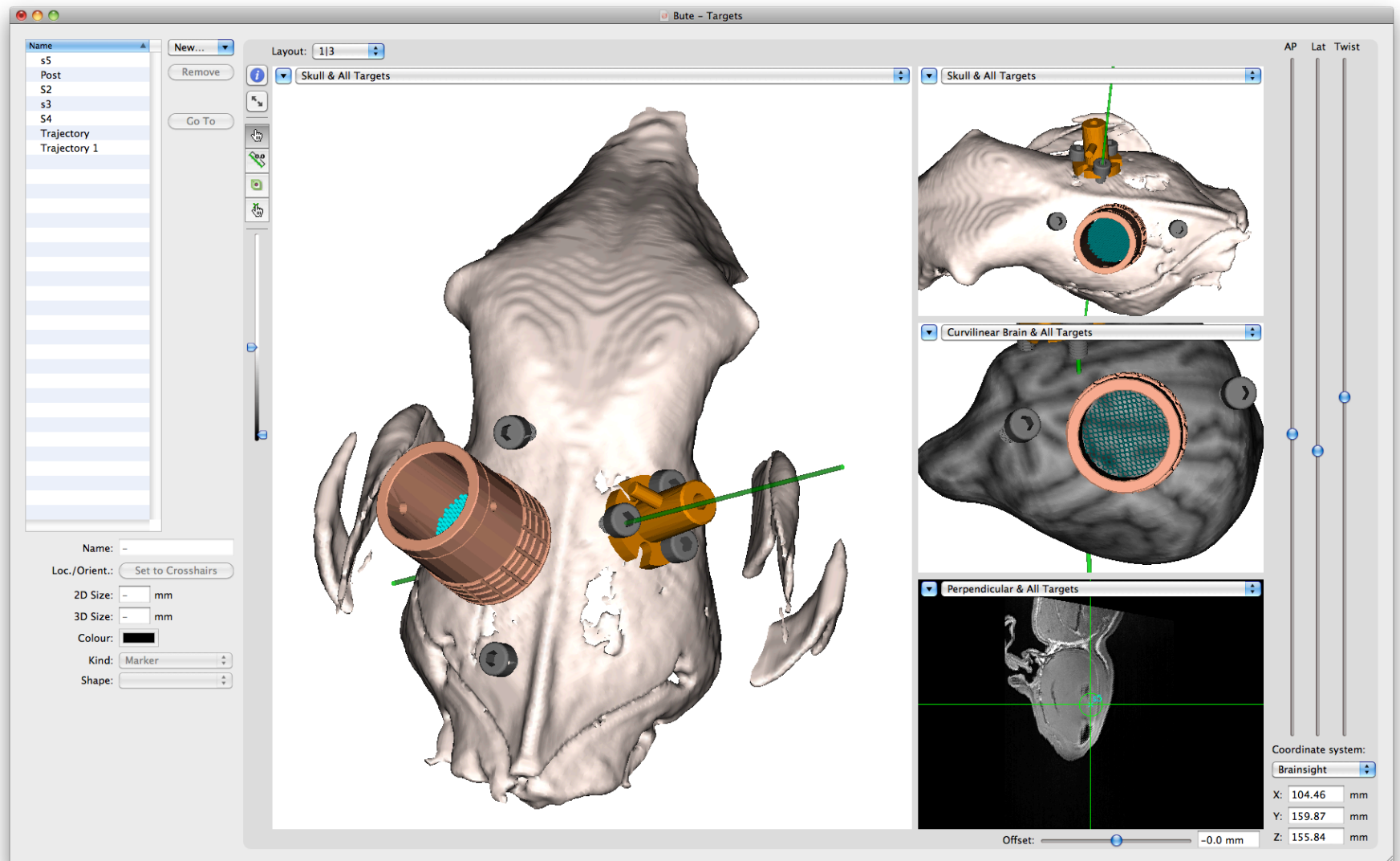

Fig. 12-7

Chamber Tool Controls.

Fig. 12-8

Example of a "busy" skull with numerous screws and implants derived from CAD files. This display allows for careful planning of complex surgeries.





# Chapter 13: Performing the Robot Surgery

Up to this point, you have spent valuable time preparing for this event. Like preparing for an exam, preparing for surgery will maximize the probability of success and save time in surgery, where the value of time in anesthesia, animal comfort and operating room cost is significant.

This chapter will cover one of the most common surgical procedures: Needle placement (e.g. injection, or biopsy) which involves using the robot to drill a small hole and to guide a needle through that hole to a target deep in the brain.

Note most surgical procedures can be carried out with the robotic arm.

## INTRODUCTION

Any surgical procedure involving the robot will include the following steps (in general):

- Preparing the robot and surgical instruments
- Placing the animal in the stereotaxic frame and placing the stereotaxic frame on the robot base plate
- Performing the subject-image registration
- Drilling the entry hole
- Placing the needle

To start the process, click **Sessions** in the project window to bring up the target manager window (see Fig. 13-1).

## PREPARING THE ROBOT AND SURGICAL INSTRUMENTS

You will be performing a surgical procedure that involves creating an incision in the skin along the skull surface, and retracting an opening large enough to expose the upper skull.

**Before performing any surgery, you should be intimately familiar with the operation of your stereotaxic head holder and related tools. Lack of experience with these tools can lead to contamination of the sterile field, loss of navigation system accuracy, or injury to the animal if the head comes out of the clamp during surgery. It is strongly advised to go through this procedure with a mock-up (either a cadaver, or plastic skull supplied in your Brainsight kit) to establish a clear and acceptable protocol.**

## Parts required

In addition to your preferred tools to create a midline incision, clean the bone surface and close the wound after injection, you will require:

- Surgical robot with stereo cameras and plastic sleeve to cover robot (optional)
- Laser pointer tool
- Stereotaxic head holder (suitable for your animal) with the necessary fixation hardware to attach it to the robot base plate (supplied)
- Drill (attached to robot tool holder) with a suitable bit to drill a hole in the skull (supplied)
- Needle and holder (attached to robot tool holder)
- Neuronavigation computer

You will also need the following consumable supplies:

- Injection syringe with 6" needle or other
- Bone wax (if desired)
- Supplies required to perform the skin incision and suture it closed after surgery.

## Surgery preparation-computer setup

1. Prior to the animal arriving, bring in the Brainsight computer and connect it to the Robot controller module (See Chapter 3" Setting Up the Brainsight Robot").
2. Following the steps in Chapter 3" Setting Up the Brainsight Robot" and Chapter 4" Calibrating Robot

Tools", set up the robot and calibrate your drill and needle. It is possible to calibrate tools during surgery, but it is easier to do so without the animal being on the robot base plate.

## Surgery preparation-position subject and expose skull

This procedure depends on the details of your animal holder.

1. Place the animal in the stereotaxic frame, taking into consideration the anesthesia equipment and expected location(s) of the robot during surgery.
2. Place the stereotaxic frame on the robot base plate and using the fixation thumbscrews, secure it to the plate.
3. Using your approved technique, carry out an incision along the mid-sagittal plane and retract to expose the bone. Recall the optimal exposure as described in Fig. 13-4 to maximize registration accuracy.

## Begin the surgery in Brainsight

1. If you have not done so yet, launch Brainsight and load the Brainsight project file associated with your subject and surgical planning.
2. Click on **Sessions**, to bring up the Sessions step (see Fig. 13-1), then click **New->Robot Surgery**. A new window will open (see Fig. 13-2) with the steps to perform the surgery displayed as icons along the top.
3. Selecting your target(s) is the first step. If you created targets in the targeting step (see Chapter

Fig. 13-1

Surgery Session Manager Window.

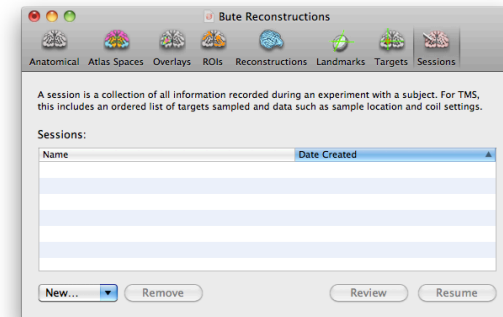
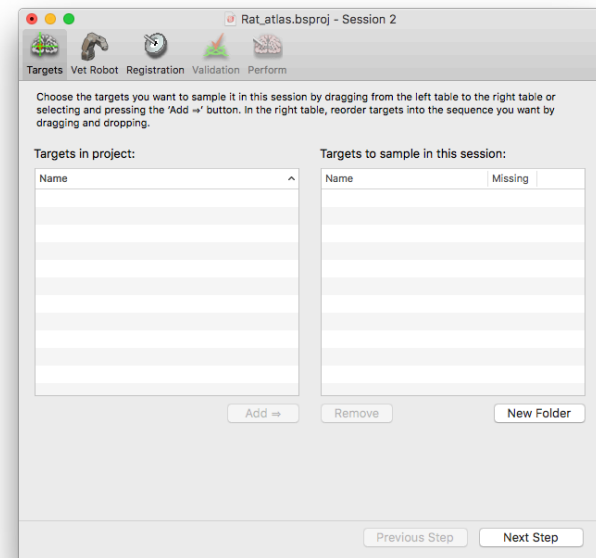

Fig. 13-2

New surgery session window showing target selection step.





12" Selecting Targets for Surgery"), select the ones you wish to use in this surgery (it is possible to have multiple targets for multiple surgeries, and you may only want a subset displayed in this session) and click **Add=>** to move them to the right-hand side of the list. You can also drag and drop them from the list on the left to the list on the right.

4. Click **Next Step**.

### Connect to the robot

1. If the robot is on and correctly connected to the Brainsight computer, you should see it in the robot connection control popup button (see Fig. 13-3). Select it and click **Connect**. After a moment, you should see the connection status change to "connected". Once this occurs, you should see live images of the stereo cameras appear in the two

- views. The robot may also perform an internal calibration by moving around. At the end, it should end at the home position.
2. Attach the Laser pointer to the robot and turn it on.
3. Using the robot controls, move the robot such that the laser pointer is pointing straight down, onto the exposed skull (so that you see the red dot on the skull).

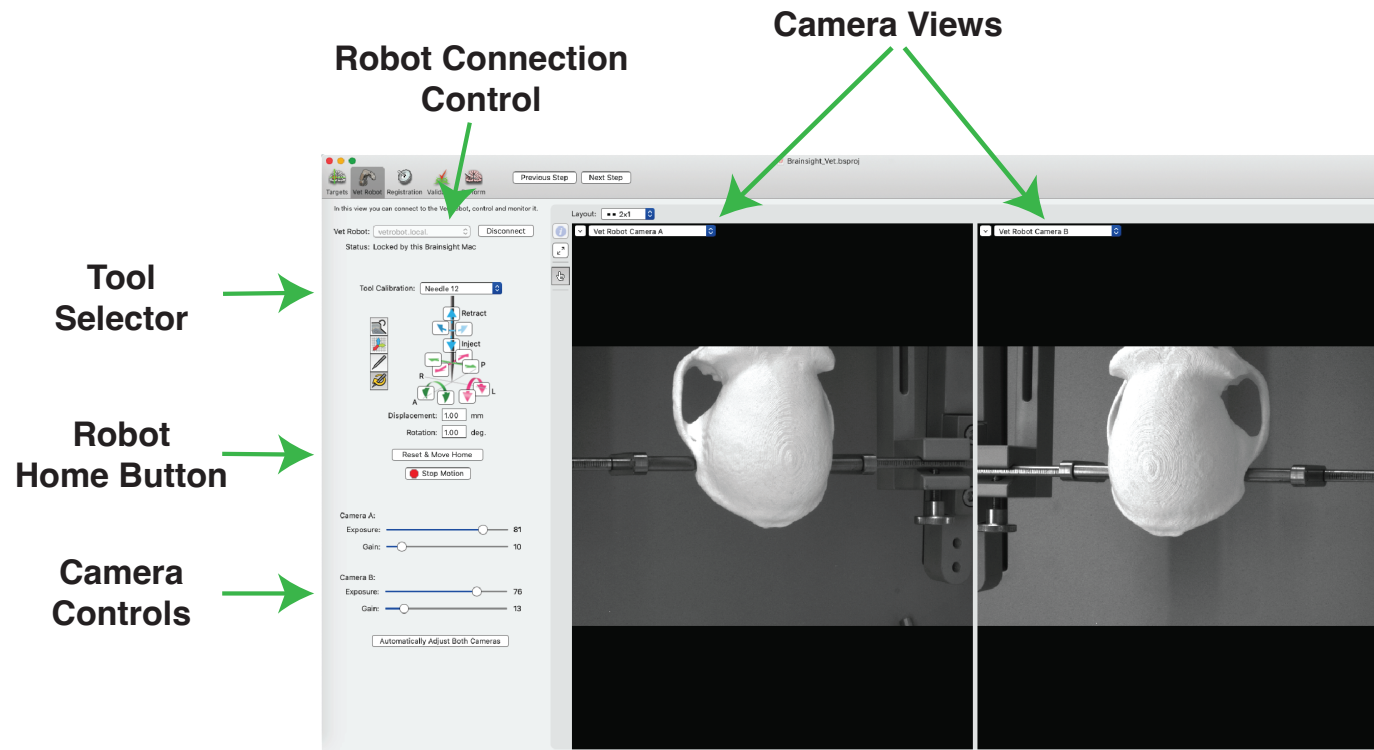

Fig. 13-3  
Robot Connection Window.

- Adjust the camera controls to maximize the visibility of the laser dot on the skull while minimizing the visibility of other structures. The goal is to ensure the laser dot is the brightest object in each image.
- Adjust the laser size (see Fig. 13-4) to the smallest size while remaining visible in the camera views.
- Go to **Landmarks** with the laser off. Lower the exposure and gain so that cameras A and B are fairly dark, only the laser dot being visible. Click on **Capture Background Image**.

### Registration

The registration step itself is a multi-step process. The steps are presented in the registration window vertically along the left from top to bottom.

- Identify the skull 3D reconstruction you want to use for the point matching by selecting it from the list in the **Skull** popup button.
- In both camera views, use the painting tools (similar to those used in the ROI step (see Chapter 9 "Region of Interest (ROI) Painting") to delineate the visible skull. This will be used by Brainsight to decide where to put the grid nodes for the registration. Take care not to paint regions of skin or surgical tools. If the skull has features not present during the scan (e.g. drilled holes from a previous surgery), make sure you exclude them.
- Using the robot movement tools, move the laser

Fig. 13-4

Laser pointer on removable tool assembly.

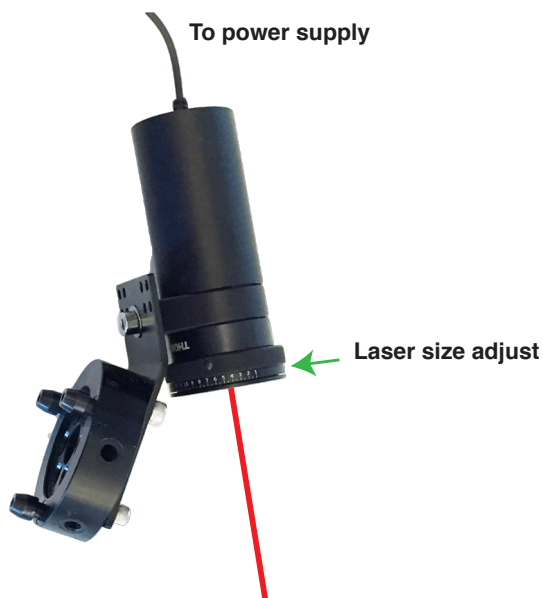

- pointer to identify the first landmark on the skull identified in the registration landmark step (see Chapter 13 "Selecting Registration Landmarks"). Once on the landmark, click **Sample & Go To Next Landmark**.
- Move the laser pointer using the robot controls to the second landmark and click **Sample & Go To Next Landmark** again. Note that you can select either

landmark on the list and re-sample it if needed by moving the laser pointer to the landmark and click **Sample & Go To Next Landmark** again.

- Enter a grid spacing value in the Grid Spacing entry box. The default is 1mm, so you can also leave that value there. A smaller value will acquire more grid points, but will increase the time needed to sample the grid.
- Click **Start Grid** to have Brainsight sample the grid on the skull. This process will take a few minutes.
- Make sure you have selected the appropriate skull reconstruction.

Once the grid has completed, you should see an image similar to Fig. 13-6. The area of each camera view that has been delineated should have a series of dots on it. Note that only the area of the skull that was delineated in both views is used, so it is normal for delineated areas in the images to not have any markers. The colour of the dots gives an indication of the confidence in the 3D location of the point. Points that are on partially visible, or on a slanted part of the skull (with respect to the camera plane) tend to have lower confidence because the shape of the laser dot (when viewed by the camera) may not be round. In general, if most of the points are green, then it is an indication that the grid was successfully acquired. If most of the points are yellow or red or large patches of skull have no dots, then this is an indication that the grid acquisition was not successful. In this case, try to reduce

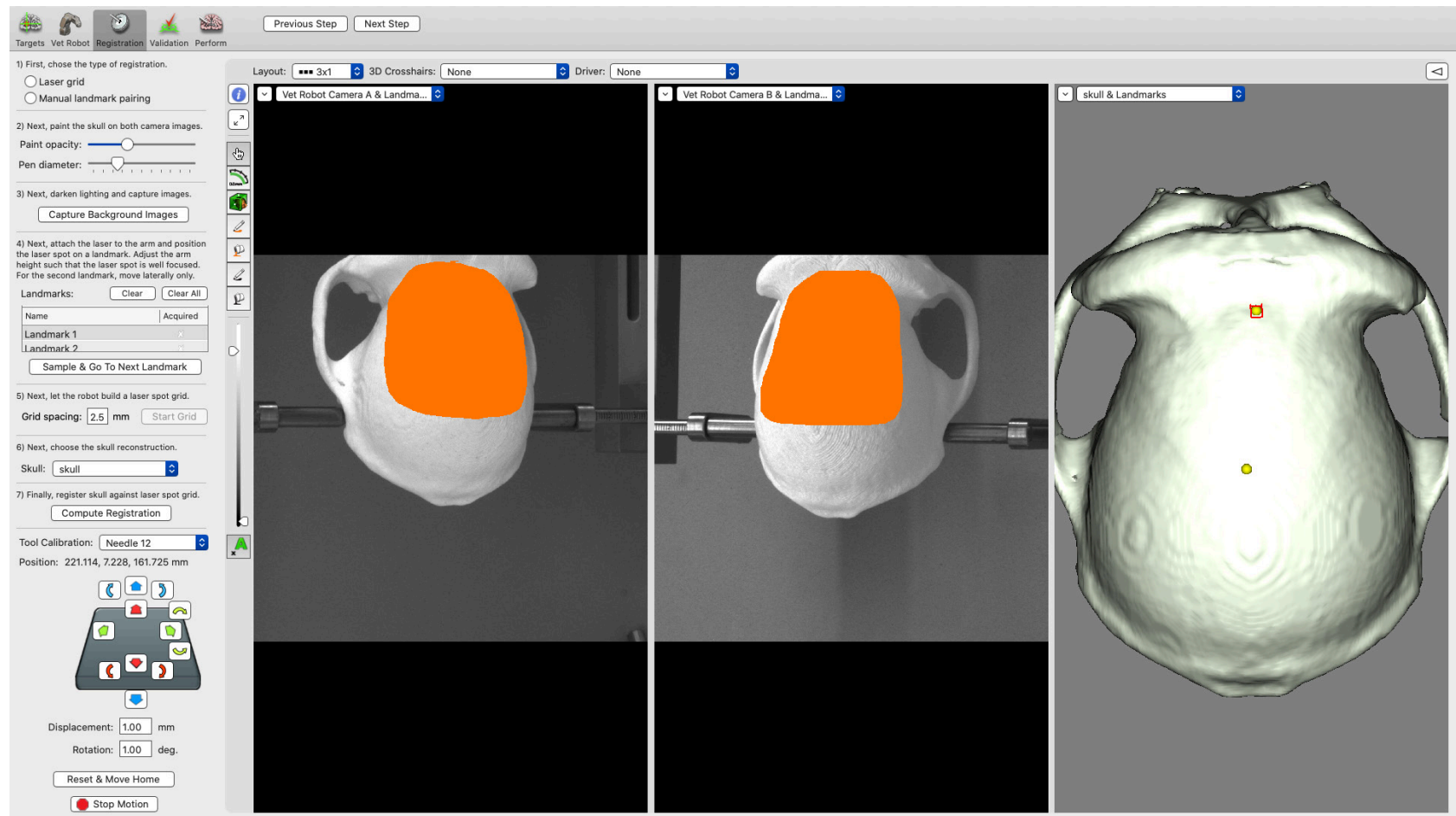

Fig. 13-5

Registration Window.

the room lighting, return to the robot step and adjust the camera settings. It may take a bit of trial and error at first to learn what camera parameters work best for your surgical environment. It would be advisable to note these values for future surgeries.

8. If the grid looks acceptable, then click **Compute Registration** to generate the registration. After the calculation (which may take several seconds), a 3D representation of the grid will appear in the 3D view, on the skull. Examine this view carefully as it represents the quality of the registration result.

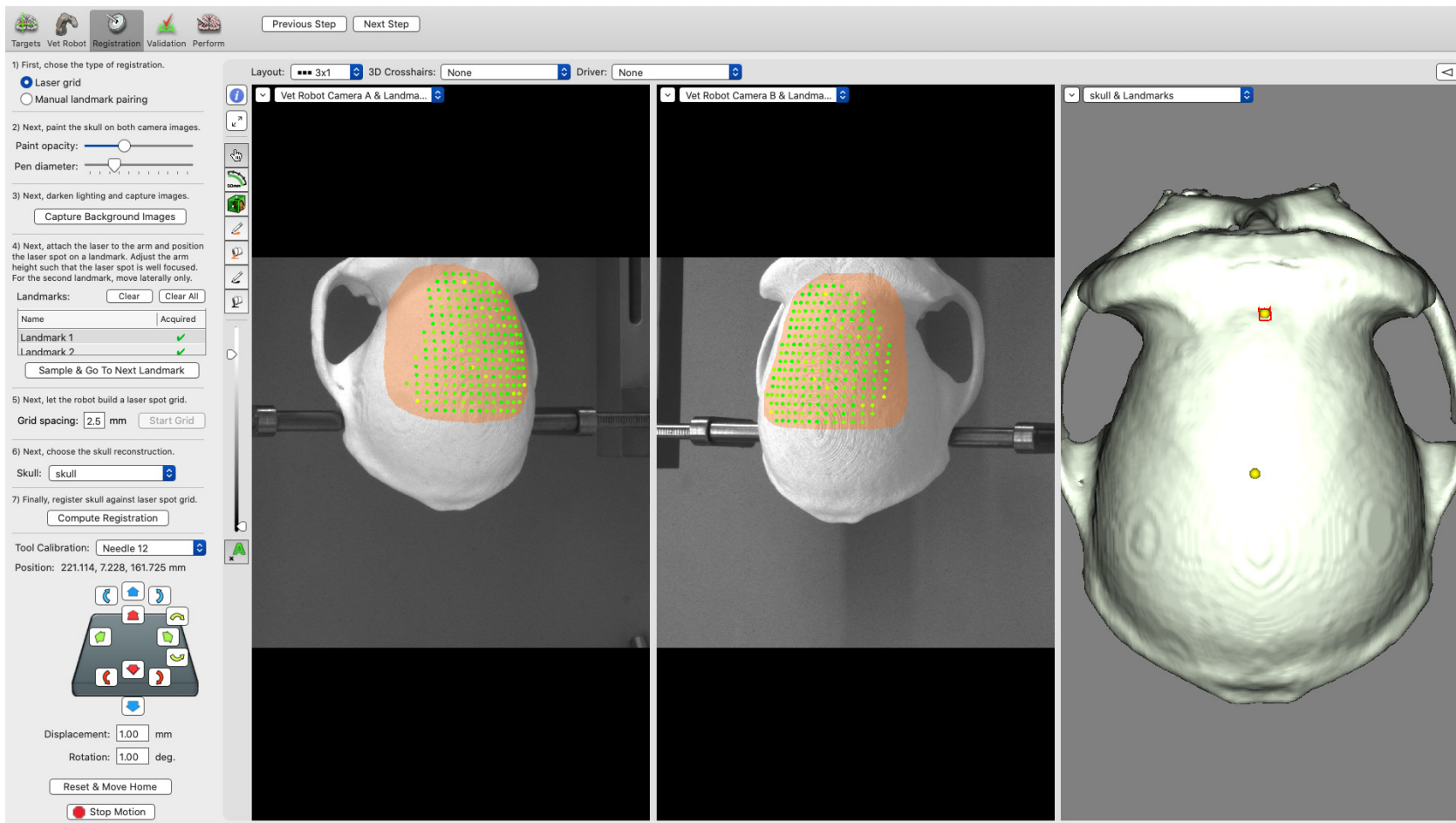

Fig. 13-6

Image of the registration grid on the camera views. A good grid will have mostly green dots and some yellow ones.

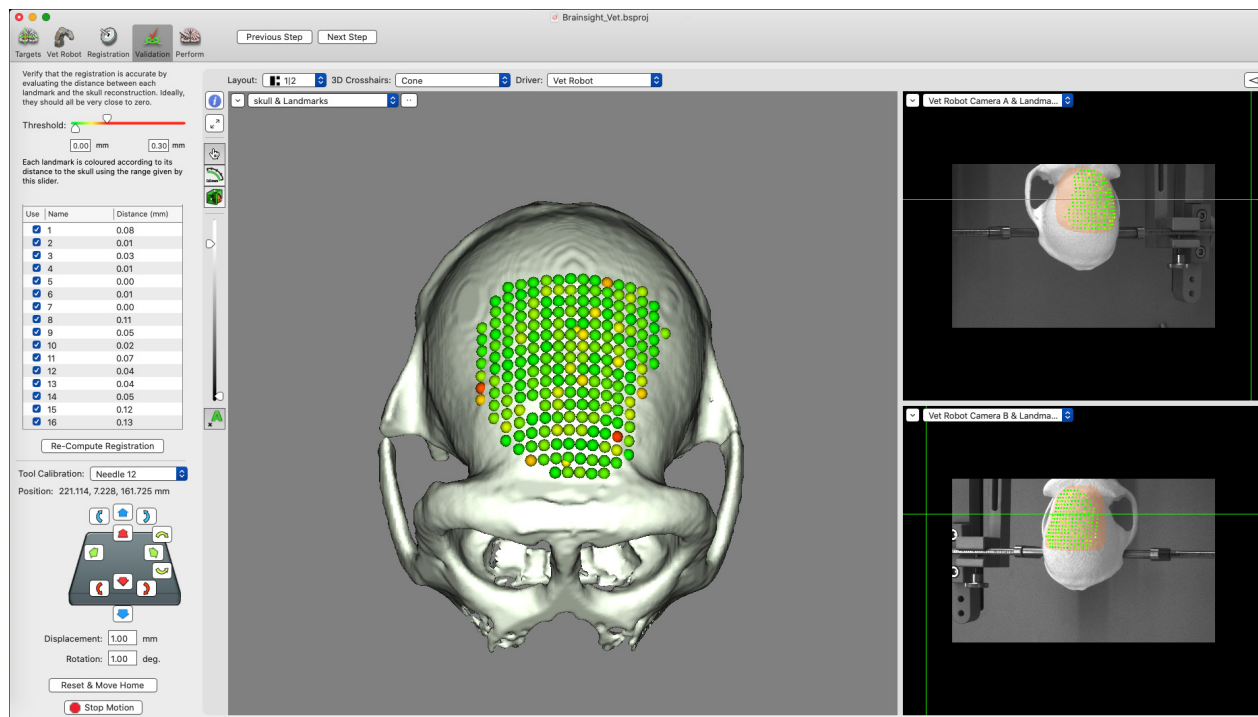

Fig. 13-7

**3D display of the registration grid on the skull. A good registration will have the spheres sitting on the surface of the skull. The green colour indicates high confidence in the location of the grid point.**

The location of the spheres is determined by the location of the points from the camera images and using the calculated registration matrix, mapped to the 3D view. The colour of the sphere represents the distance from that sphere to the closest location on the skull (so you have both the position of the sphere on the skull and the color to help you assess the quality of the fit). If both the 3D locations and colour indicate a higher than acceptable discrepancy, then the registration procedure should be repeated.

9. If the registration is deemed acceptable, then click **Next Step**.

### Alternate registration

If imaging scans (MRI and/or CT) are not of sufficient quality to extract the bone for 3D registration, it is possible to perform a manual registration. This technique can also be used when an animal has little real estate left of the skull.

1. A scan is still needed (either MRI or CT), which can identify certain specific points, divots or edges. These "landmarks" also need to be visible to both of the stereo cameras.
2. Add the "landmarks" in the Landmark section of the Brainsight software. It is best to include at least 3 or more landmarks.
3. In **Sessions**, click on each landmark and press **Add...**

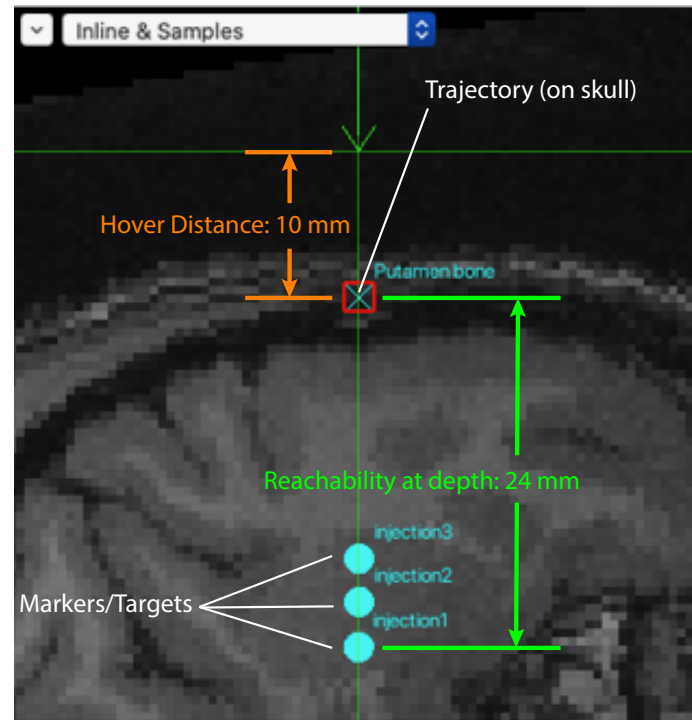
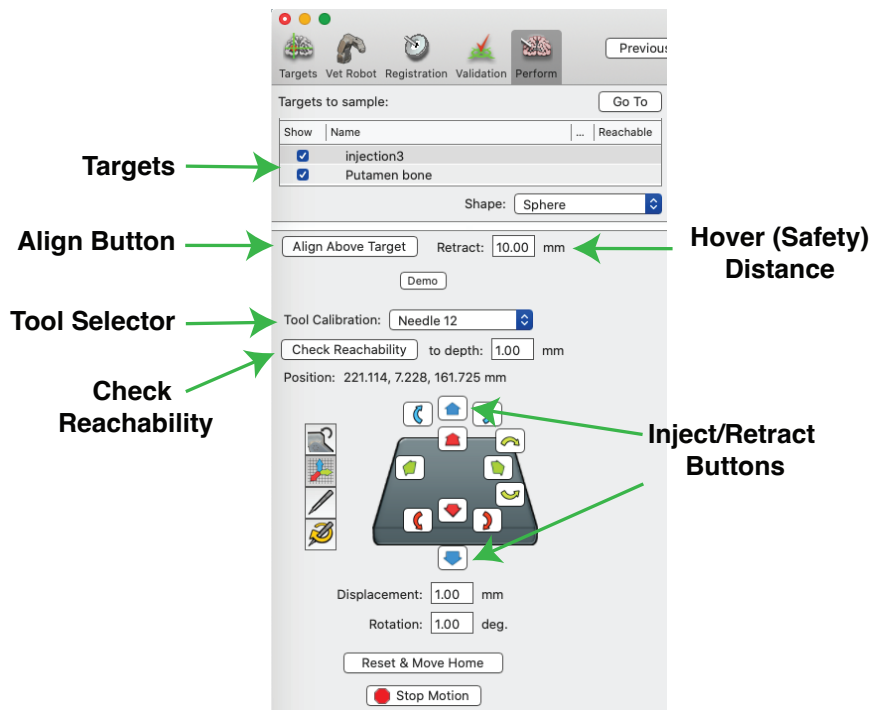

Fig. 13-8

**Tool manipulation controls:** the Target represents the desired final location of the tool. When a target is selected and the Align to Target button is pressed, the robot will move to align itself to the trajectory, but will place the tip of the tool above the origin of the trajectory with the distance away from that origin set by the Retract distance (the hover distance). Clicking inject/retract will move the tool along the trajectory by a distance set by the Displacement value.

### Drilling the entry hole

Now that the registration is complete, the actual surgery can take place. Remove the laser pointer from the removable tool assembly and place the drill onto it. It is assumed that the drill has been calibrated (see Chapter 4 "Calibrating Robot Tools"). Before proceeding, familiarize yourself with the robot tool controls (see Fig. 13-8).

Note that the main concept of how the robot is manipulated is by using trajectories. We first align the robot tool to a given trajectory with the tip a safe distance from the expected final location, then we use the inject/retract

buttons to move the tool in small increments towards/away from that origin along that trajectory. We use the term inject and retract (but inject really means advance in a more general way). To drill the hole, we will have the robot move the drill to the trajectory (and hover a safe distance above), then "inject" the drill to the skull surface, then continue the inject while it drills into the skull.

1. Select the drill tool from the tool list.
2. Click **Check Reachability**. Brainsight will check to make sure that all targets on a trajectory are

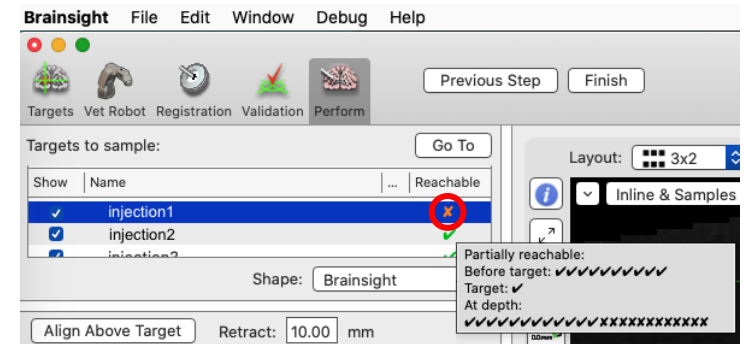
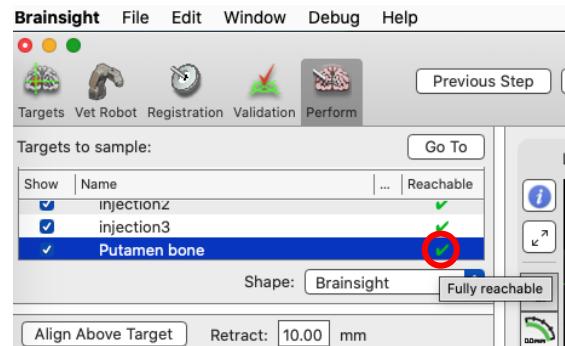
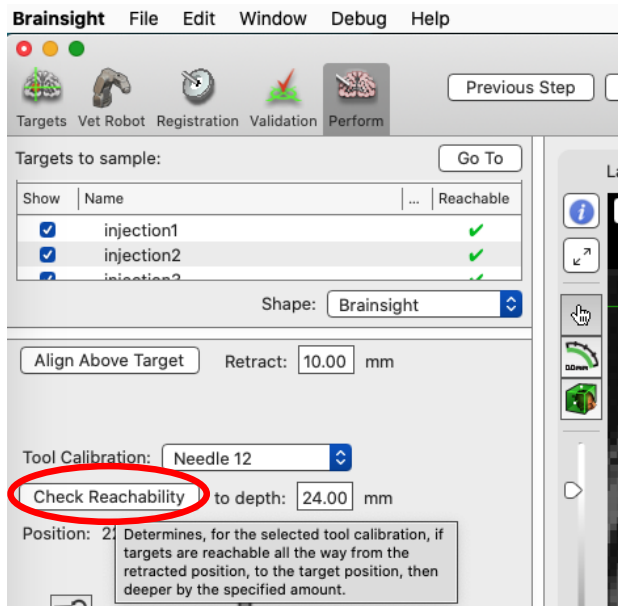

Note that each tick mark (✓) or X mark (X) is 1mm.

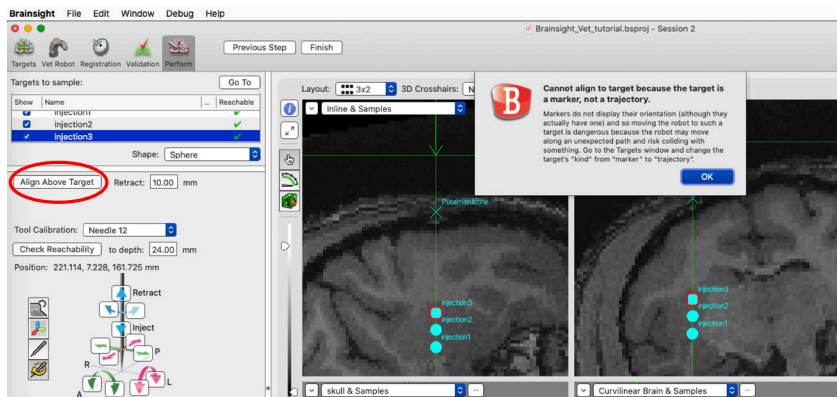

Note: the robot will not align to Markers. An error message will be displayed if you attempt to align to a Marker with the robot.

Fig. 13-9

Below: Screenshot of the drill at the skull surface. Right: Picture of the drill at the skull.

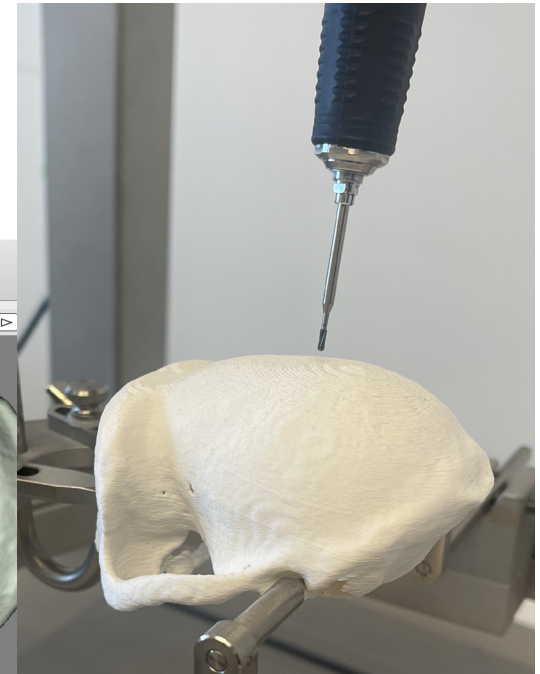
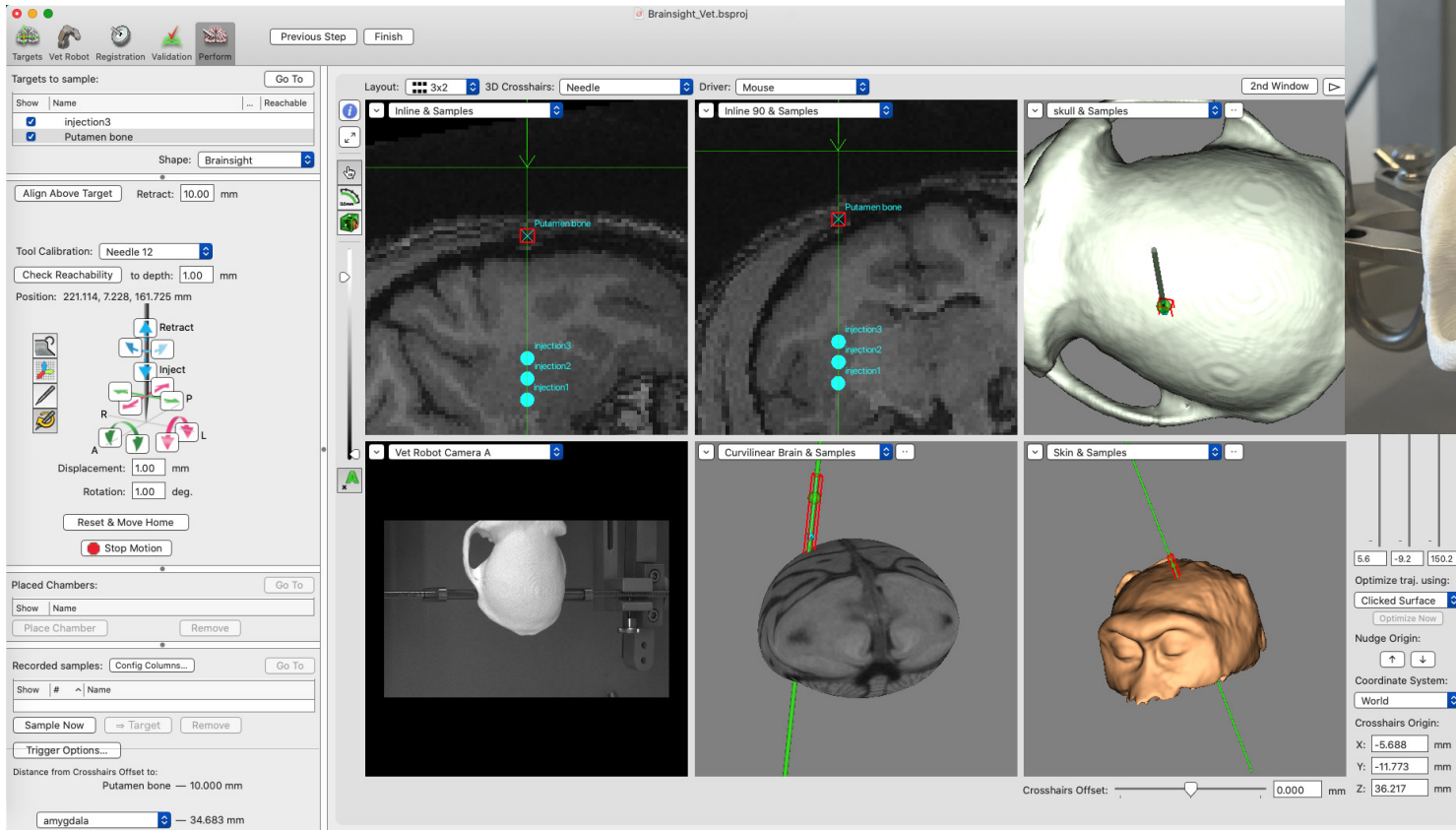



reachable based on the selected tool that has been calibrated. Note that target reachability now checks not only if the target is reachable but it also allows you to check many millimeters below your target. A new textfield in the Perform window allows you to set this value (**at depth**). Note that with the drill bit you do not want to go any further than the inner table of the skull/dura.

3. Select the trajectory target that is associated with the location of the hole to be drilled from the target list. It is assumed for this example, that the origin of the trajectory was set to the skull surface.
4. Enter a number in the **Retract** text field. A value of 10–15mm is reasonable.
5. Click **Align To Target**. Note the robot will move the drill to align it to the trajectory on the bone but have the tip of the drill above the skull.
6. Set the Displacement distance to 1mm (in the **Displacement** text box).
7. Click the **Inject** button and note the robot move 1mm towards the skull. Continue to click the **Inject** button (keep count) 9 more times to move the drill to the skull surface. Note that as you get closer to the skull, pay special attention to make sure you do not actually contact the skull. If there was a registration error (where the system “thinks” the skull is further away than expected, the drill may reach the skull before you expect it to. Conversely, you may find

that after moving the 10mm, there is still a gap.

8. Change the Displacement distance to a smaller value, say 0.1mm (100 micrometers).
9. When the drill is at the skull surface (but not in contact), turn on the drill.
10. Click **Inject** to move the drill into the skull and begin drilling the hole. Use the images on the screen to estimate the thickness of the skull and click **Inject** to move the drill as many steps as needed. While drilling, you may choose to apply irrigation to cool the drill, skull and tissue under the skull according to your standard surgical protocol. If needed, retract the drill to examine the condition of the hole to observe when the drill has pierced through the skull.
11. Once the hole is complete, click **Retract** repeatedly (you can change the displacement distance back to 10mm to move more quickly) until the drill is a safe distance from the hole, then click **Reset and Move Home** to bring the robot to the home position.
12. Remove the drill from the robot removable tool assembly.

### Perform the injection

The injection procedure (e.g. electrode implantation, etc.) is very similar to the drilling procedure. We assume that you have defined a target where the origin is the final location of the injection site within the brain with a trajectory that goes through the hole in the skull. The essential operation is to place the needle holder on the robot,

select a safe hover distance (**Retract** text field), align the tool to the target trajectory, then use the **Inject** button to move the needle into the brain for the injection.

1. Select the injection tool from the tool list.
2. Select the trajectory target that is associated with the location of the injection target to be reached from the target list. It is assumed for this example, that the origin of the trajectory was set to the injection site.
3. Enter a number in the **Retract** text field. A value of 10mm PLUS the depth of the target to the skull surface is reasonable.
4. Click **Align To Target**. Note the robot will move the needle to align it to the trajectory but have the tip of the needle 10mm above the skull.
5. Set the Displacement distance to 1mm (type 10 in the **Displacement** text box).
6. Continue to click the **Inject** button (keep count) 10 more times to move the needle to the skull surface. Note that as you get closer to the skull, pay special attention to make sure you do not actually contact the skull. If there was a registration error, you may note that the needle is not aligned with the hole. This may occur for a number of reasons:
  - The head may have moved in the stereotax. If this is the case, you will need to replace the head in the stereotax and restart the surgery from the point of registering the head to the images, then

verify that the hole drilled was at the correct location to determine if the injection can proceed, or if a new hole needs to be drilled.

- The tool calibration for the needle, electrode, etc. was not correct. Repeat the tool calibration for the needle to see if this corrects the issue.
  - The tool calibration for the drill was not correct. Repeat the tool calibration for the drill and see if the drill still aligns to the original hole (by repeating the steps in “Drilling the entry hole”). You may need to drill a new hole if the original one was misplaced, or if possible, generate a new injection target trajectory that accommodates the misplaced hole.
7. If the injection needle is aligned with the drill hole as expected, then continue with the injection process. Before allowing the needle to come into contact with the brain, reduce the displacement distance to a smaller number (say 0.1mm).
  8. Click **Inject** to move the needle into the brain. Use the images on the screen to monitor the progress. Note that the distance to the injection site is displayed on the bottom left of the screen. Continue clicking **Inject** until you reach your target, then proceed with your injection (or whatever your experiment is once you have reached your target).
  9. Once the injection is complete, click **Retract** repeatedly (you can change the displacement distance

Fig. 13-10

**Selecting desired speed and distance on the controller module.**



back to 10mm to move more quickly once you are out of the brain ) until the drill is a safe distance from the hole, then click **Reset and Move Home** to bring the robot to the home position.

10. Remove the needle from the robot removable tool assembly.
11. Complete the surgery according to your surgical protocol.

#### Constant motion

In some cases, an electrode or other device may need to be inserted into the brain at a constant speed (e.g., 10 $\mu$ m/s over 2mm).

1. Click **Align To Target** and Go To Target.
2. Click on **Inject** until the electrode or device is hovering above the brain.
3. On the touch screen of the controller module, select the desired speed and distance (see Fig. 13-10).
4. Click on **Start**.

# Chapter 14: Reviewing Study Data

After one or more sessions, it is often useful to review the data acquired. Brainsight 2 has several tools to help review the results of the session as well as export these to external files so you can perform more detailed analysis.

The main purposes for review are:

- To verify that the targets to be reached were indeed reached (compare targets to samples).
- To sort through the data and export relevant information for detailed analysis.
- To pick recorded locations and convert them to targets for subsequent sessions.
- To review recording locations after recording sessions, or to pool multiple sessions into one review screen for comparison.
- To configure the display window and take screenshots for publication.

Review is initiated from the Session manager pane by clicking **Review**, which will open a new display window (see Fig. 14-1). Select one or more sessions from the list on the left by clicking, or option-clicking on the sessions.

## DISPLAYING THE DATA

The window shows a list of targets and samples and a 2x2 image display layout. You can of course change it (for example, a 1x3 layout, as shown in Fig. 14-1). The samples list represents a union of the samples from the selected sessions. You can manipulate content of the list display by clicking **Configure...**, and enabling and/or disabling the available fields. You can display the samples in the image views for comparison by clicking the visible checkboxes in the lists. You can also change the display layout (as in any display window) to your preference by

Fig. 14-1

Session Review Window.

The screenshot displays the Brainsight Session Review Window. On the left, the 'Targets' panel lists various targets, with 'Circ. Grid 1' selected. Below it, the 'Sessions' and 'Data Samples' panels show a list of samples with columns for Name, Target, Error, and EMG channels. A 'Sample Details' panel at the bottom left shows parameters for a selected sample, including 2D size, color, kind, shape, and location. The central 3D brain model shows a grid of electrodes on the cortical surface. On the right, the 'Copy of Skin & Samples' panel shows a brain slice with electrode locations, and the 'EMG' panel shows a graph of voltage (µV) over time (ms) with peak-to-peak averages for two channels.

Sample #	Name	Target	Error	EMG Ch 1	EMG Ch 2
146	Sample 146	Circ. Grid 1	1.1 mm	12	10
147	Sample 147	Circ. Grid 1	1.5 mm	16	10
148	Sample 148	Circ. Grid 1	0.7 mm	14	10
149	Sample 149	Circ. Grid 1	1.0 mm	16	10
150	Sample 150	Circ. Grid 1	0.4 mm	42	10
151	Sample 151	Circ. Grid 1	0.9 mm	22	6
152	Sample 152	Circ. Grid 1	0.6 mm	42	10
153	Sample 153	Circ. Grid 1	0.6 mm	20	12
154	Sample 154	Circ. Grid 1	0.6 mm	2684	216
155	Sample 155	Circ. Grid 1	0.6 mm	1998	197
156	Sample 156	Circ. Grid 1	0.6 mm	2149	185
157	Sample 157	Circ. Grid 1	1.1 mm	2250	181
158	Sample 158	Circ. Grid 1	0.6 mm	143	18
159	Sample 159	Circ. Grid 1	0.3 mm	32	18
160	Sample 160	Circ. Grid 1	1.3 mm	196	22
161	Sample 161	Circ. Grid 1	0.2 mm	99	10
162	Sample 162	Circ. Grid 1	1.1 mm	14	10
163	Sample 163	Circ. Grid 1	0.9 mm	16	10
164	Sample 164	Circ. Grid 1	1.1 mm	12	8
165	Sample 165	Circ. Grid 1	1.6 mm	12	8
166	Sample 166	Circ. Grid 1	0.3 mm	14	14
167	Sample 167	Circ. Grid 1	0.8 mm	16	10
168	Sample 168	Circ. Grid 1	1.4 mm	20	10
169	Sample 169	Circ. Grid 1	0.7 mm	14	10
170	Sample 170	Circ. Grid 1	1.0 mm	95	14
171	Sample 171	Circ. Grid 1	0.9 mm	20	14

clicking in the list headings to change the display order.

The review display window uses a similar layout as the perform window with a few changes.

- A new list, the session list, can be seen next to the samples list. You can show or hide all the samples from a particular session as a group in the image views by enabling the **show** checkbox. You can show one or multiple sessions by clicking on their respective **show** boxes.
- The samples list displays all the samples from a session selected from the sessions list. Selecting multiple sessions in the sessions list will add all the samples from each highlighted session into the samples list. This is distinct from showing or hiding a sample in the image views. The samples list is to allow you to selectively view the attributes of one or more samples. Selecting another session in the sessions list will affect what is shown in the samples list, but not what is being displayed on the images. Clicking **Configure Columns...** opens a window where you can enable or disable the display of any attribute in the samples list to simplify sorting on any one of them.
- The target list will have all the targets created in this project. You can display any of the targets in the image views by enabling their respective **show** checkbox.

## EXAMINING THE DATA AND CHANGING ATTRIBUTES

Samples can be made visible or hidden using the show checkbox. To show or hide all of the samples quickly, select any sample, press **⌘-a** to select the entire list (or shift-click or **⌘-click** to select a group from the list), then **cntrl-click** or right-click on the list and select **Show Selected Samples** or **Hide Selected Samples** from the popup button.

When a sample is selected (and visible on any of the image views), the sample will be highlighted by a red bounding box. When multiple samples are selected, each one is highlighted.

Selecting a sample in the samples list will display its attributes under the samples list. Many of these attributes were acquired when the sample was recorded, such as the current target at the time and the EMG waveform (if you were recording EMG). Many attributes are user selectable, such as the colour and shape of the sample. These can be changed at any time. Selecting multiple samples will display the common attributes. Changing any of these will be applied to all the selected samples.

The samples list represents a union of the samples from the selected sessions. You can manipulate content of the list display by clicking **Configure...**, and enabling and/or disabling the available fields. You can display the samples in the image views for comparison by clicking the show checkboxes in the lists. You can also change the display layout (as in any display window) to your preference by

clicking in the list headings to change the display order.

As was possible during the TMS session, you have access to the inspector tool to customize the image view, change the display attributes of the 3D surfaces as well as use the motor maps feature.

## CONVERTING A SAMPLE TO A TARGET

It is common for a target to be derived from the results of a previous session. You can easily convert (copy) a recorded sample into a target by dragging the sample from the sample list into the target list. The **Convert to Target...** button present while performing the session performs the same function as dragging and dropping them.

It is common for the recorded sample locations to have a scalp or skull surface point as its origin while it is often preferable to have the target's origin set somewhere in the cortex. After creating the target as described above, use the target positioning tool and nudge tool to nudge the target into the cortex.

## EXPORTING THE DATA

You can also export the targets or acquired sample data to a text file for more detailed analysis. Select the samples you wish to export from the list, then click **Export...** to open the export dialog box (see Fig. 14-2). Select the fields from among the data acquired to export. You can also select the coordinate system in which to use

for all coordinates. If you performed an atlas registration, then you can use atlas coordinates in addition to the Brainsight and World coordinates. You can save the anatomical landmarks used for registration (which can be useful to co-register the data to another software package), the targets and of course the samples gathered during the session. Enter a file name (and navigate to the desired folder), and then click **Save**.

### Exported Data Format

If the selected coordinate system was set to Brainsight coordinates, then the coordinates will be dependant on the anatomical data set (see Fig. 14-3). All trajectories contain 3 vectors, representing the orientation of the 3 axes of the recorded tool in the Brainsight coordinate frame. Take note that the z axis of a tool pointing towards the head will be pointing in the opposite direction.

### Attribute description

All data are written as strings. If it is described as an integer, it is implied that this is the format of the string. Note that some attributes were added with newer versions of Brainsight. If you are exporting a session that was acquired with an older version, the newer attributes may not be included since they were not recorded at that time.

- **Sample name** [string.]: the name of the sample.
- **Index** [integer]: The index of the sample assigned in the order of the creation of the samples. If samples were deleted after they were created, the indexes are

Fig. 14-2

### Data export box.

The selected attributes of each sample will be exported as a text file. The format is a straightforward tab-delimited text file.

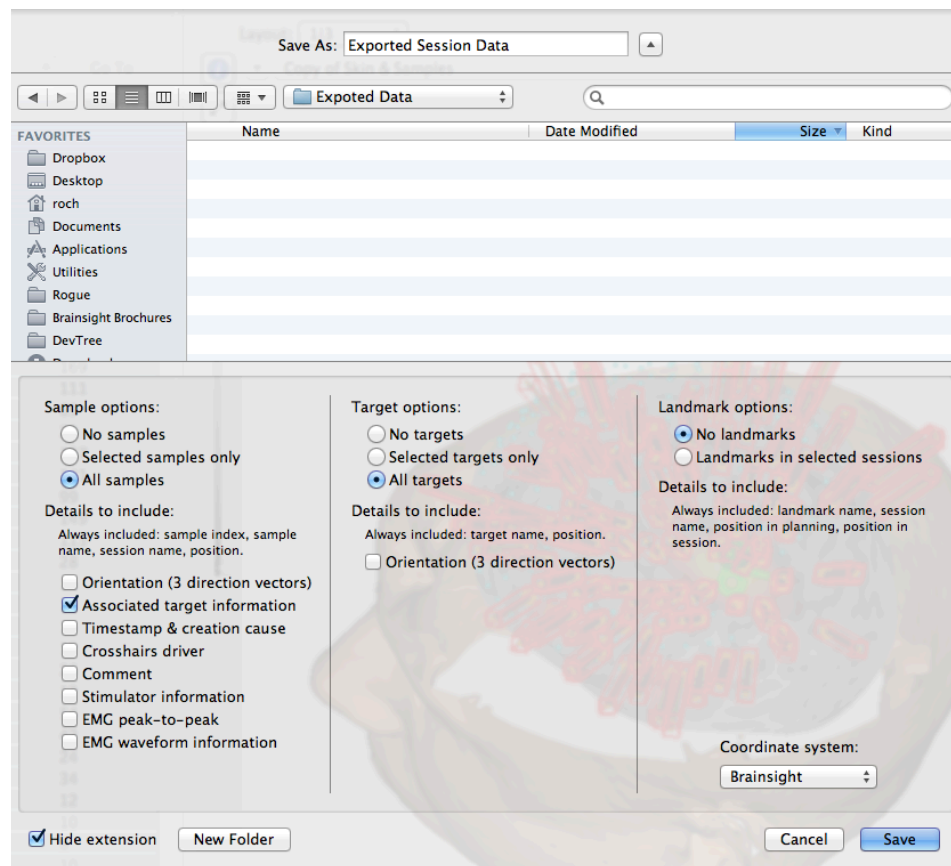
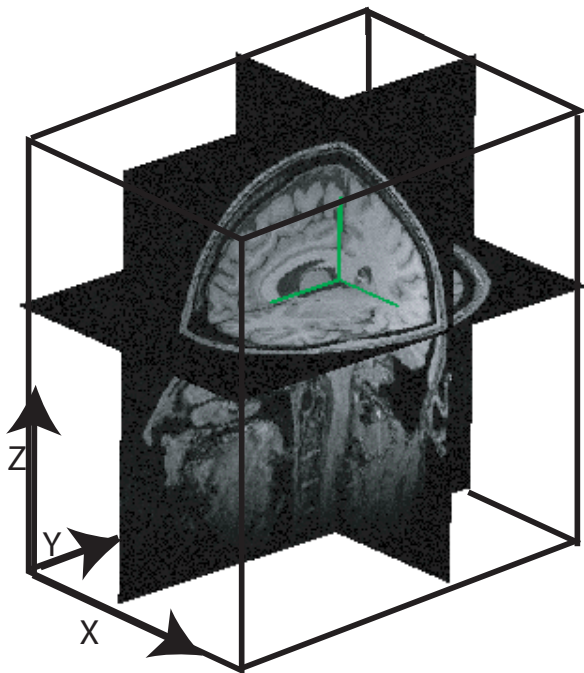

Fig. 14-3

Brainsight's internal coordinate system.



not reused.

- **Assoc. Target** [string]: the name of the target that was current at the time of the sample.
- **Crosshairs driver** [string]: Name of the tool that was being tracked when the sample was generated. Possible values are Mouse, Pointer or the name of the tracked tool given when it was calibrated.
- **Lox X (Loc Y & Loc Z)** [float]. X, Y and Z values of the location of the tracked tool at the time the sample was taken.
- **m0n0 m0n1 m0n2** [float]: The orientation (direction cosine) of the x axis of the tracked tool in the host coordinate space. See for a description of the tracked tool coordinate system and how to use the location and direction cosines to assemble the tool to image transform. This transform can be used to convert points relative to the tool to points in the image space (e.g. projections along the tool's z axis into the head).
- **m1n0 m1n1 m1n2**: [float]: The orientation of the y axis of the tracked tool in the host coordinate space.
- **m2n0 m2n1 m2n2**: [float]: The orientation of the z axis of the tracked tool in the host coordinate space.
- **Dist. to target** [float]: The straight line distance from the coil reference point to the target.
- **Target Error** [float]: The shortest distance from the line projecting into the head along the tool's path.

- **Angular Error** [float]: The tilt error of the tool with respect to the initial path to target.
- **Date** [string]: The date the sample was acquired in YYYY-MM-DD format.
- **Time** [string]: The time (according to the system clock) in HH:MM:SS.XXX were HH is the hour, MM is the minute, SS is the second and XXX is the millisecond.

You can perform the export more than once and switch coordinate systems between exports to export the data in multiple coordinate systems.

Fig. 14-4

Illustration of the relationship between the tool position and orientation described by the loc and direction cosine values. They can be assembled into a matrix to convert coordinates relative to the tool into Brainsight, world or atlas coordinate spaces. For example, to find the Brainsight coordinate of a point 15mm under the tool, multiply the transform matrix by the vector [0, 0, 15, 1].

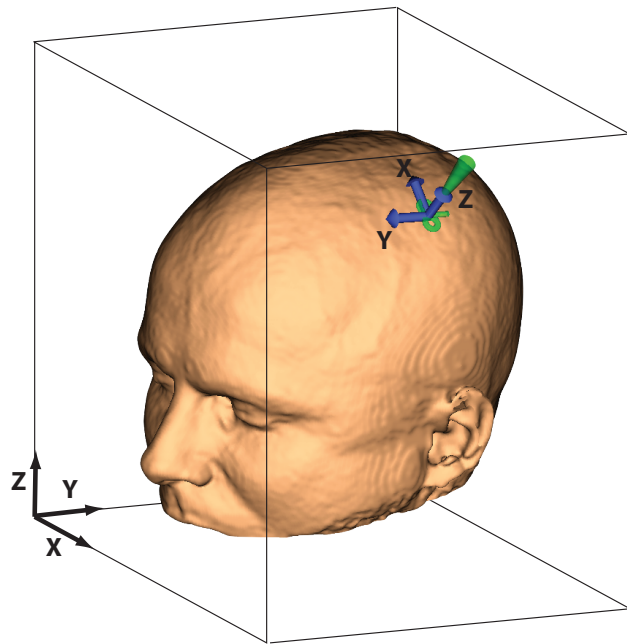

excerpt from export

... Loc. X Loc. Y Loc. Z m0n0 m0n1 m0n2 m1n0 m1n1 m1n2 m2n0 m2n1 m2n2 ...

$$\begin{bmatrix} m0n0 & m1n0 & m2n0 & \text{Loc } x \\ m0n1 & m1n1 & m2n1 & \text{Loc } y \\ m0n2 & m1n2 & m2n2 & \text{Loc } z \\ 0 & 0 & 0 & 1 \end{bmatrix} \cdot \begin{bmatrix} X_{\text{coil}} \\ Y_{\text{coil}} \\ Z_{\text{coil}} \\ 1 \end{bmatrix} = \begin{bmatrix} X_{\text{bs}} \\ Y_{\text{bs}} \\ Z_{\text{bs}} \\ 1 \end{bmatrix}$$



### OPTIONAL TROLLEYS FOR THE VET ROBOT SYSTEM

Contact [info@rogue-research.com](mailto:info@rogue-research.com) for more details.

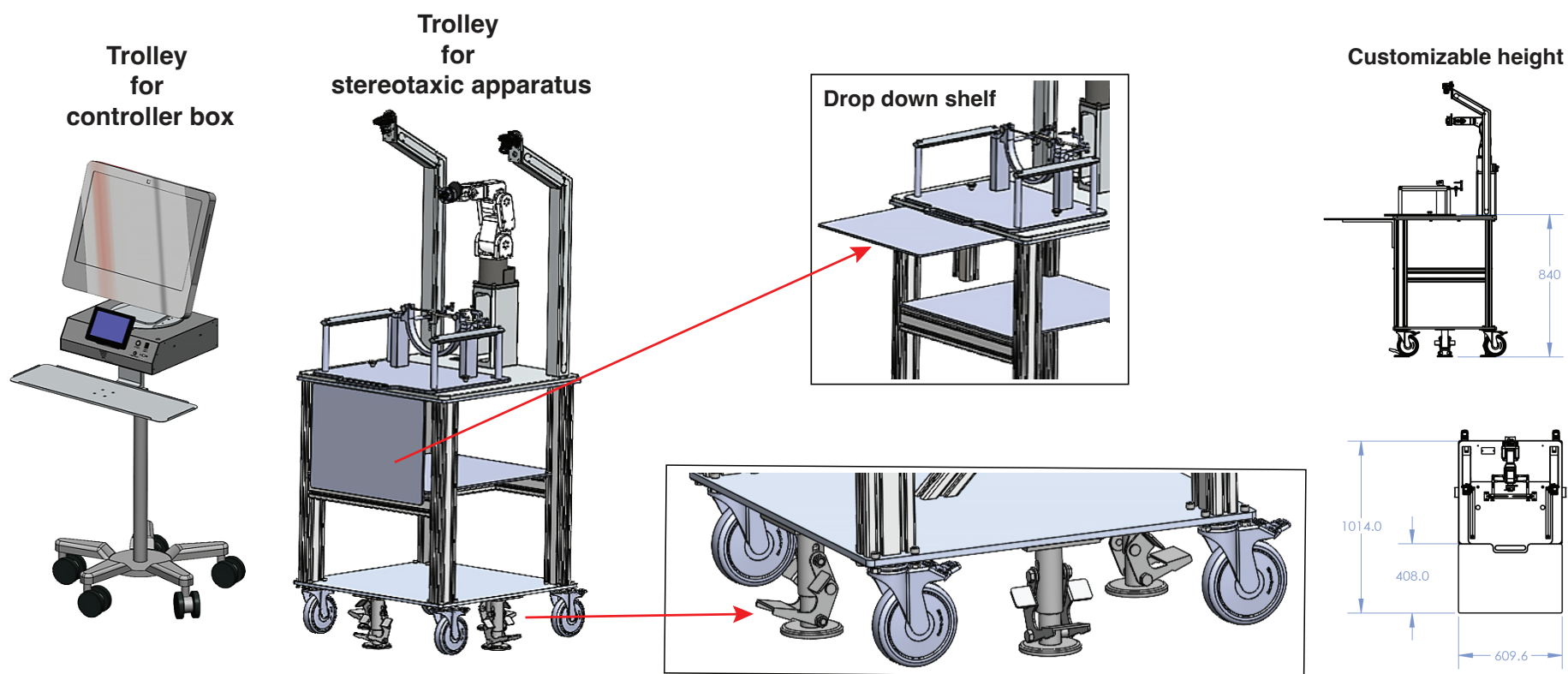

Fig. 14-5

Optional trolleys for the Vet Robot system.

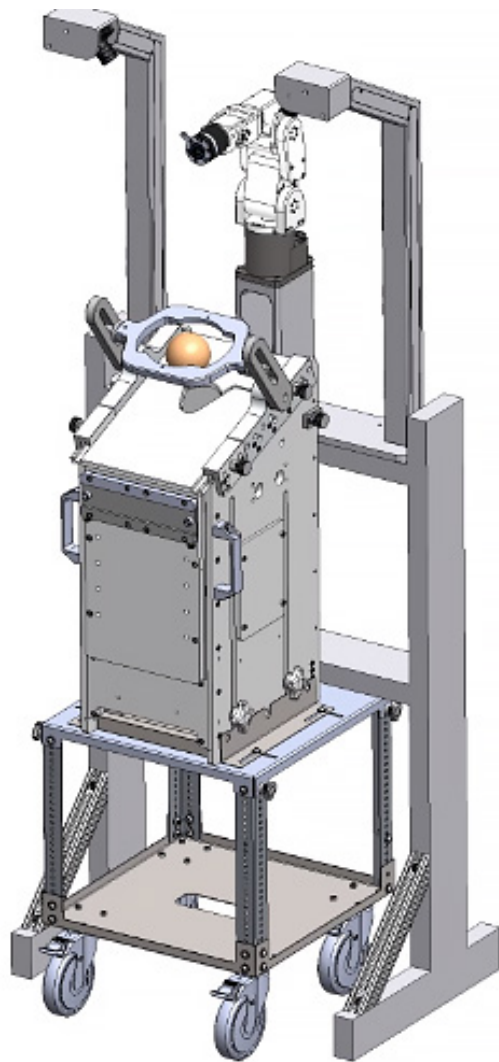

Fig. 14-6

**Optional awake macaque robotic set up for electrode or focused ultrasound preparations.**

Contact [info@rogue-research.com](mailto:info@rogue-research.com) for more details.



# Brainsight<sup>®</sup>

Vet

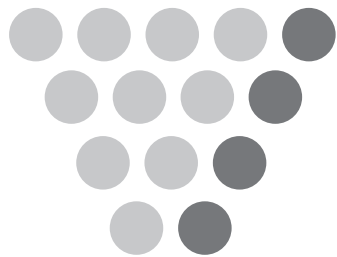

**Rogue Research Inc.**

**Rogue Research Inc.**  
300-6666 Rue. St. Urbain,  
Montreal, QC H2S 3H1  
Phone: (514) 284-3888  
Toll Free (North America):  
1-866-984-3888  
Fax: (514) 284-6750  
<http://www.rogue-research.com>