

Brainsight[®]

NIBS

USER MANUAL
v2.5.6
(January 2025)

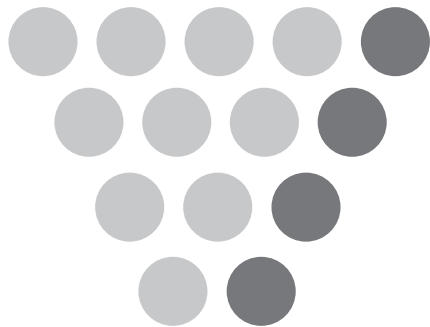

 **Rogue Research Inc.**

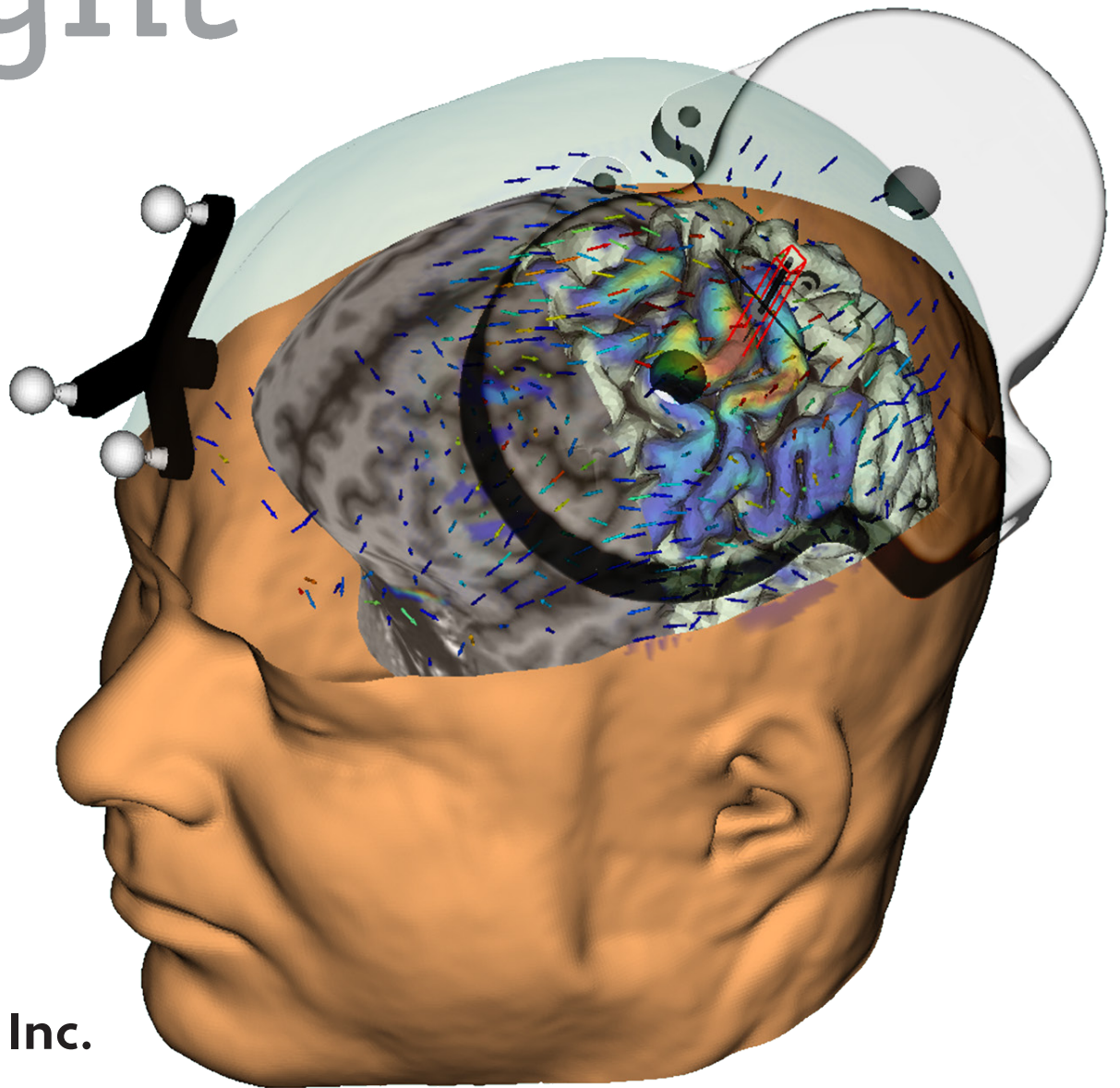



Rogue Research Inc.

Rogue Research Inc.
6666 Boul. St. Urbain, #300
Montreal, QC
H2S 3H1

+1 (514) 284-3888
866-984-3888 Toll Free (North America)
(514) 284-6750 Fax
info@rogue-research.com
support@rogue-research.com

Note:

The Brainsight software includes the latest user manual pertinent to that software version. You can access it electronically within the Brainsight application by selecting "View User Manual" from the help menu. This will launch a document viewer where you can view or print the manual.

Your Serial Number is:

Your Computer Password is:

Brainsight®

NIBS

USER MANUAL
v2.5

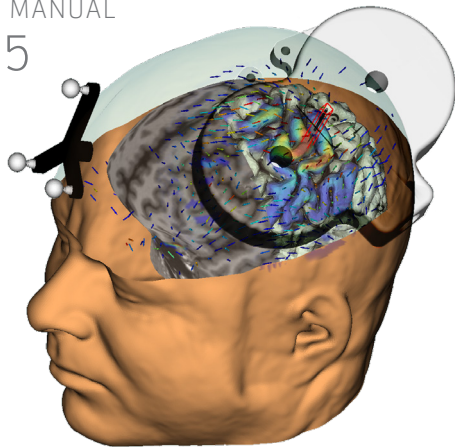

Index

End-User Software License Agreement	vii	Warnings and Cautions	xvii
1. License.	vii	Change Log	xvii
2. Permitted Uses and Restrictions.	vii	KNOWN ISSUES:	XXVII
3. Copyright.	vii	SAFETY SYMBOLS	XXVII
4. Transfer.	viii	GENERAL WARNINGS	XXVII
Trademarks	viii	ERROR MESSAGES	XXVII
INTENDED USE	VIII	Installing Brainsight and using the Polaris Camera	xxvii
BASIC SAFETY AND PERFORMANCE	VIII	Calibrating Your Tool	xxviii
Basic Safety and Performance List	ix	Loading Anatomical Images	xxviii
BRAINSIGHT PART DESCRIPTION (JANUARY 2024 MODEL)	IX	3D Reconstruction	xxix
Component License agreements	ix	Chapter 1: Introduction	1
VTK	ix	HOW THIS DOCUMENT IS ORGANIZED	1
ITK	x	Document formatting	1
GDCM	x	THIS USED TO BE CALLED BRAINSIGHT TMS, OR BRAINSIGHT 2 TMS?	1
OpenCV	xi	HOW TO GET HELP (or HOW YOU CAN HELP US MAKE BRAINSIGHT BETTER FOR YOU)	2
AMSerialPort	xi	Chapter 2: The Gen 1 Trolley with Vicra or Vega	3
Remote Control Wrapper	xi	COMPUTER	3
FeedbackReporter	xi	TROLLEY	3
libusb	xii	I/O BOX	3
Labjack exodriver	xvi		
MNI 152 Average Brain (used in MNI-based projects)	xvii		

Tools required:	5	Installing the I/O Box and the Isolation Transformer	17	Statement of intended use	29
Instructions	5	Installing the Computer	19	Safety Symbols	29
Using the computer	8	Install the monitor	19	Safety Tips	30
Software Updates	8	Install the Keyboard Tray	19	Contraindications	32
SETTING UP THE POLARIS POSITION SENSOR	8	Connecting the cables	19	OPERATING, TRANSPORT AND STORAGE	
Setting up a Vicra camera	8	Connecting Peripherals (optional)	21	ENVIRONMENT	32
Testing the Camera	11	Setting up your Lyra Camera	21	Operating	32
TROUBLESHOOTING TRACKING PROBLEMS	11	Setting up your Vega Camera	23	Transport	32
CLEANING THE TROLLEY AND COMPONENTS	12	OPERATING THE GEN-2 TROLLEY	23	Storage	32
Chapter 3: Gen 2 Trolley with Lyra or Vega	13	Testing the Camera	24	Expected Product Lifetime	32
SCOPE:	13	POWERING DOWN THE GEN-2 TROLLEY	24	MAIN COMPONENTS:	32
ACRONYMS AND ABBREVIATIONS	13	TROUBLESHOOTING TRACKING PROBLEMS	24	Differential amplifier.	32
SAFETY SYMBOLS	13	CLEANING THE TROLLEY AND COMPONENTS	24	CLEANING THE EMG DEVICE	34
BASIC DESCRIPTION	14	DEVICE COMPONENTS	25	INSPECTING THE EMG DEVICE	35
Operating	14	Brainsight System with trolley, Mac Mini, Lyra and EMG	25	PREPARING THE EMG DEVICE FOR USE	35
Transport	14	Brainsight System with trolley, Mac Studio, Lyra and EMG	25	If you have the standalone analog receiver:	35
Storage	14	Brainsight System with trolley, Mac Mini, Vega and EMG	25	If you have the Gen-1 or Gen-2 I/O box:	35
Expected Product Lifetime	14	Brainsight System with trolley, Mac Studio, Vega and EMG	25	Connecting the EMG Parts to the Analog Receiver or I/O Box	35
WARNINGS AND CAUTIONS	14	EMI/EMC TABLES	25	USING THE EMG DEVICE.	35
SETTING UP THE TROLLEY	16	Chapter 4: EMG Pod	29	No trigger box hardware can be found	36
Main Components (unpacked)	16	SAFETY NOTES	29	TROUBLESHOOTING	36
Unpacking the System	16			Further Assistance	37
Assembling The Trolley	17			ELECTROMAGNETIC COMPATIBILITY	37
				EMG SYSTEM SPECIFICATIONS	37

Overall System:	37	Perform 3D reconstruction(s)	46	To use the average brain template:	65
Sensors:	37	Select anatomical landmarks for registration	48	WHEN TO USE THE MODEL HEAD VS. SUBJECT-SPECIFIC MRI?	65
ANALOG CABLE PINOUTS	37	Select your target(s)	48	THE IMAGE DISPLAY WINDOW	66
PARTS LIST	37	Perform a TMS session	48	Layout Control	66
With I/O box (vers model NTB003)	37	Review the acquired data	49	View Configuration (HUD)	66
With I/O box (vers model NTB002)	38	Chapter 7: Calibrating Your Tool	51	View selector	67
DISPOSAL	38	PLACING THE TRACKER ON THE TMS COIL	51	Inspector	67
Chapter 5: Installing Brainsight	39	Coil-Specific Tracker Adapters	52	Full Screen Control	67
COMPUTER SETUP	39	MANAGING TOOL CALIBRATIONS	54	Cursor Tool	67
GET THE SOFTWARE	39	PERFORMING A TOOL CALIBRATION	54	3D Ruler Tool	67
INSTALLING THE SOFTWARE	40	SPECIAL CONSIDERATION FOR FUS TRANSDUCERS	58	3D Crop Box	67
SETTING YOUR PREFERENCES	42	Chapter 8: Importing Brainsight 1.7 Projects	59	Chapter 10: MNI/Talairach Registration	71
Chapter 6: The Overall Steps of Image-guided NIBS	45	MAPPING THE OLD TO THE NEW	59	MANUAL MNI REGISTRATION	72
INTRODUCTION	45	Importing the Project into Brainsight 2	59	LOADING A PRE-EXISTING MATRIX	74
NEURONAVIGATION	45	Chapter 9: Loading Anatomical Images	61	A NOTE ABOUT MNI AND TALAIRACH SPACE	74
TYPICAL STEPS FOR IMAGE-GUIDED TMS	46	OPENING A PREVIOUSLY SAVED PROJECT	62	Chapter 11: Image Overlays	75
Calibrate your TMS Coil	46	CREATING A NEW PROJECT USING SUBJECT-SPECIFIC IMAGES	62	ADDING FUNCTIONAL OR ANATOMICAL OVERLAYS	75
Select the Anatomical Data Set	46	CREATE A NEW SIMNIBS-BASED PROJECT	63	LOADING AN MNI ATLAS FOR OVERLAY	77
Co-register to the MNI (and Talairach)	46	CREATE A NEW PROJECT USING THE MODEL HEAD IMAGE SET	65	Chapter 12: Region of Interest (ROI) Painting	79
Coordinate Space	46			INTRODUCTION	79
Select One or More Overlay Data Sets	46				
Create a Region of Interest Using the Region Paint Tool	46				

CREATING AN ROI	80	Rectangular grid (Fig. 15-5):	101	VERIFY PROPER POLARIS LOCATION	118
Chapter 13: 3D Reconstruction	83	Circular grid (Fig. 15-8):	102	PERFORM THE SUBJECT-IMAGE REGISTRATION (SUBJECT-SPECIFIC IMAGES)	118
PERFORMING A SKIN RECONSTRUCTION	83	CREATING A TARGET BASED ON A PREVIOUS SAMPLE	103	PERFORM REGISTRATION USING THE MNI MODEL HEAD PROJECT	121
CREATING A CURVILINEAR RECONSTRUCTION OF THE FULL BRAIN	84	USING CURRENT MODELLING TO EVALUATE A PROPOSED TMS COIL LOCATION	104	PERFORM THE STIMULATION SESSION	125
IF THE RECONSTRUCTION DOES NOT WORK:	85	Strategy for using current modelling	104	New controls in the perform window	126
CREATING A CURVILINEAR BRAIN RECONSTRUCTION USING A MODEL SHAPE	86	USING ACOUSTIC MODELLING FOR FUS TARGETING	107	Optimizing the view geometry	126
CREATING A CURVILINEAR SURFACE FROM AN ROI (FOR SMALLER STRUCTURES)	86	Using K-Plan modelling with Brainsight	107	Setting user-trigger preferences	126
CREATING A 3D SURFACE FROM AN OVERLAY	88	Using BabelBrain with Brainsight	107	Visualizing and recording EMG	128
CREATING A 3D SURFACE FROM AN ROI	89	Chapter 16:		TRACKING A SECOND COIL SIMULTANEOUSLY	130
IMPORTING 3D SURFACES FROM OTHER SOFTWARE	89	Performing the Study	113	OPENING A SECOND VIEW WINDOW (ONE COIL)	131
EXPORTING 3D SURFACES	90	PREPARE THE TRACKED TOOLS	113	Chapter 17: Special Application: Network Interface	133
Chapter 14: Selecting Anatomical Landmarks	93	Caring for the reflective spheres	113	INTRODUCTION	133
Chapter 15: Selecting Targets for Stimulation	97	PREPARE THE SUBJECT	113	ACTIVATING AND CONNECTING	134
MNI OR TALAIRACH BASED TARGETS	100	Prepare and attach the subject tracker	114	PROTOCOL	136
COORDINATE BASED TARGET	100	Using the head-strap	114	Chapter 18: Special Application-Axilum Robot	150
FMRI BASED TARGET	100	Using the glasses	115	INTRODUCTION	150
CREATING A GRID OF TARGETS	100	PREPARE THE HARDWARE	115	Special notes in preparing a Brainsight project	151
To create a grid:	101	BEGIN A NEW NIBS SESSION	115	Creating a grid of targets	151
		CONFIGURE THE I/O OR TRIGGER BOX	117	Begin the the Session	151
		Set the trigger options	117	Verify Polaris Camera Position	151
		SETTING UP THE EMG	117		

SEQUENCE OF STEPS FOR THE COBOT	153	Connect the Brainsight and NEURO PRAX computer to the same LAN	169	SAVING THE DATA	185
Prepare the robot (part I – before registration)	153	Discovering Each Other During the TMS session	170	FILE FORMAT DETAILS	185
Steps After Subject Registration	155	Digitizing Electrode Locations	172	Text (.txt)	185
Perform the stimulation	156	Recording EEG data during the experiment	172	Locator	185
SIMPLE MAPPING	157	Exporting EEG Data	172	BESA	187
WORKSPACE AND TARGET REACHABILITY	158			MatLab	187
Chapter 19: Special Application–Motor Mapping	160	Chapter 21: Reviewing Study Data	174	Chapter 23: Assembling the MRI Camera Stand	188
INTRODUCTION	160	DISPLAY WINDOW	174	PARTS LIST:	188
TARGET CONSIDERATIONS	160	EXAMINING THE DATA AND CHANGING ATTRIBUTES	176	ASSEMBLING THE FRAME	189
INPUT EMG DATA	161	CONVERTING A SAMPLE TO A TARGET	176	ADJUSTING THE OVERALL HEIGHT OF THE STAND	194
Built-in EMG Pod	161	Exported Data Format	177	INSTALLING THE VEGA CAMERA AND ETHERNET CONNECTIONS	195
Entering the values manually	162	EXPORTING TO DICOM FORMAT	179		
VISUALIZING MAP DATA	162	Chapter 22: EEG Electrode Recording	182		
Marker colorizing	162	GETTING STARTED	183		
Creating the map as an overlay	163	Setting up	183		
Detailed Description of the Mapping Algorithm	163	USING A TEXT FILE	183		
Caveats in using the MEP display	164	DIGITIZE THE ANATOMICAL LANDMARKS	184		
Chapter 20: Special Application–EEG Recording	168	DIGITIZING ELECTRODES	185		
INTRODUCTION	168	DIGITIZING HEAD SHAPE (OPTIONAL)	185		
PERFORMING SIMULTANEOUS EEG/TMS RECORDING	168				



Brainsight[®]

NIBS

USER MANUAL
v2.5

End-User Software License Agreement

PLEASE READ THIS SOFTWARE LICENSE AGREEMENT "LICENSE" CAREFULLY BEFORE USING THE SOFTWARE. BY USING THE SOFTWARE, YOU ARE AGREEING TO BE BOUND BY THE TERMS OF THIS LICENSE. IF YOU DO NOT AGREE TO THE TERMS OF THIS LICENSE, PROMPTLY RETURN THE SOFTWARE TO ROGUE RESEARCH INC.

ROGUE RESEARCH AND ITS SUPPLIERS DO NOT AND CANNOT WARRANT THE PERFORMANCE OR RESULTS YOU MAY OBTAIN BY USING THE SOFTWARE OR DOCUMENTATION. ROGUE AND ITS SUPPLIERS MAKE NO WARRANTIES, EXPRESSED OR IMPLIED, AS TO MERCHANTABILITY, OR FITNESS FOR ANY PARTICULAR PURPOSE. ANY LIABILITY DUE TO FAILURE OF BRAINSIGHT WITHIN THE 1 YEAR WARRANTY PERIOD SHALL BE LIMITED TO REPLACEMENT OF THE SOFTWARE. IN NO EVENT WILL ROGUE OR ITS SUPPLIERS BE LIABLE TO YOU, YOUR STAFF OR CUSTOMERS FOR ANY CONSEQUENTIAL, INCIDENTAL OR SPECIAL DAMAGES, INCLUDING ANY LOST PROFITS OR LOST SAVINGS, EVEN IF A ROGUE REPRESENTATIVE HAS BEEN ADVISED OF THE POSSIBILITY OF SUCH DAMAGES, OR FOR ANY CLAIM BY ANY THIRD PARTY.

BRAINSIGHT IS A RESEARCH APPLICATION, AND HAS NOT BEEN APPROVED FOR ANY APPLICATION BY ANY MEDICAL AUTHORITY. IT IS THE RESPONSIBILITY OF THE END-USER TO ENSURE THAT BRAINSIGHT IS USED IN ACCORDANCE ANY APPLICABLE LAWS.

1. License.

The software accompanying this License, whether on compact disc or any other media, the related documentation and other materials (collectively, "Brainsight Software") are licensed, not sold, to you by Rogue Research Inc. ("Rogue"). The Brainsight Software in this package and any copies which this agreement authorizes you to make are subject to this License. The Brainsight Software accompanying this License includes third party open source and other commercial software whose use is governed exclusively by the terms of their respective licenses.

2. Permitted Uses and Restrictions.

You may install the Software on up to 10 computers, so long as they are all associated with the license owner. For example, a lab member who wishes to install the Software on his laptop for the purposes of preparing or reviewing data acquired by this system.

- You may use Brainsight for investigational use.
- You may not use Brainsight for therapeutic or diagnostic applications or for surgical guidance involving humans.

3. Copyright.

The Software is owned by Rogue and its suppliers, and its structure, organization and code are the valuable trade secrets of Rogue and its suppliers. The Software is also protected by Canadian Copyright Law and International Treaty provisions. You must treat the Software just as you

would any other copyrighted material, such as a book. You may not copy the Software or the Documentation, except as set forth in the “Permitted Uses and Restrictions” section. Any copies that you are permitted to make pursuant to this Agreement must contain the same copyright and other proprietary notices that appear on or in the Software. You agree not to modify, adapt, translate, reverse engineer, decompile, disassemble or otherwise attempt to discover the source code of the Software, except in the case of included third party software where such rights are expressly granted by their respective licenses. Trademarks shall be used in accordance with accepted trademark practice, including identification of trademark owner’s name. Trademarks can only be used to identify printed output produced by the Software. Such use of any trademark does not give you any rights of ownership in that trademark. Except as stated above, this Agreement does not grant you any intellectual property rights in the Software.

4. Transfer.

You may not rent, lease, sublicense or lend the Software or Documentation. You may, however, transfer all your rights to use the Software to another person or legal entity provided that you transfer this Agreement, the Software, including all copies, updates and prior versions, and all Documentation to such person or entity and that you retain no copies, including copies stored on a computer.

Trademarks

Brainsight® is a trademark of Rogue Research, Inc. Polaris® and Vicra™ are registered trademarks of Northern Digital, Inc. Macintosh®, Mac OS X® and QuickTime® are registered trademarks of Apple Computer, Inc. Intel® is a registered trademark of Intel Corporation or its subsidiaries in the United States and other countries.

INTENDED USE

Brainsight NIBS is intended to plan and guide position of NIBS tools over preselected brain regions based on previously acquired anatomical images (e.g., T1 MRI), and optionally record resulting MEPs. Brainsight NIBS is intended for research applications only, and is not intended to treat or diagnose patients.

The research market includes (but is not limited to) cognitive neuroscience, neurological research, kinesiology, motor, vision and language research.

BASIC SAFETY AND PERFORMANCE

Based on the intended use, Brainsight® NIBS is intended to plan and guide position of NIBS tools over preselected brain regions based on previously acquired anatomical images (e.g., T1 MRI), and to optionally record resulting MEPs (Motor Evoked Potential). Brainsight® NIBS is intended for research applications only, and is not intended to treat or diagnose patients. The research market includes (but is not limited to) cognitive neurosci-

ence, neurological research, kinesiology, motor, vision and language research.

Because Brainsight® NIBS is not intended for any clinical application, none of the primary functions are defined as essential performance. Immunity testing (e.g., ESD, EFT) therefore only validate basic safety. Failure to achieve those primary functions would only impact the validity of research studies, and would not lead to any unacceptable risk. It would not affect the safety, diagnosis, or treatment of patients.

Those primary functions of the system are described below. It is noted that based on the following rationale for each of them, the Brainsight NIBS system does not have any essential performance.

Basic Safety and Performance List

ID	Function	Essential Performance Y/N	Rationale
1	The system shall be able to measure and display the position (3D location and orientation) of a tracked NIBS tool in the anatomical/world coordinate space. This could be used for the user to monitor the position of a tracked NIBS tool in real-time.	N	<p>The loss or degradation of the functions to measure and/or display the position of a tracked NIBS tool can result in no record of output data for visualization of the position; this halts the user from monitoring the position of a tracked NIBS tool in real time. This could lead to delays in a research study, but does not lead to any unacceptable risk.</p> <p>The loss or degradation of the functions to accurately measure and/or display the position could lead to an error in NIBS tool positioning. This could affect the results of a research study leading to an invalid conclusion. This could impact the validity of a research study, but does not lead to any unacceptable risk.</p>
2	The system shall be able to measure and display the connected EMG Device data (if connected, up to 2 channels).	N	<p>The loss or degradation of the functions to measure and/or display the EMG data can result in no available output data on the MEP response from NIBS for the user to evaluate the motor threshold (MT); and to use for calibration of the NIBS parameters. This could lead to delays in a research study, but does not lead to any unacceptable risk.</p> <p>The loss or degradation of the functions to accurately measure the EMG response could lead to an invalid calibration of the NIBS parameters. This could affect the results of a research study, leading to an invalid conclusion. This could impact the validity of a research study, but does not lead to any unacceptable risk.</p>
3	The user shall be able to record and display a "sample". A "sample" is a timestamp to which shall be recorded the measured position of the currently tracked NIBS tool as well as the measured EMG Device data (if any).	N	The loss or degradation of the functions to record and display a "sample" data can result in no collection of "sample" data for a research study. This could lead to delays in a research study, but does not lead to any unacceptable risk.
4	The system shall be able to create a "sample" using an external TTL signal (BNC interface).	N	The loss or degradation of the functions for detection of an external trigger to record a "sample" data could result in no collection of "sample" data for a research study when external TTL signal is used. This could lead to delays in a research study, but does not lead to any unacceptable risk.
5	The system shall be able to create a "sample" using a provided footswitch device.	N	The loss or degradation of the functions for detection of a footswitch event to record a "sample" data could result in no collection of "sample" data for a research study when a footswitch device is used. This could lead to delays in a research study, but does not lead to any unacceptable risk.

BRAINSIGHT PART DESCRIPTION (JANUARY 2024 MODEL)

System Name: Brainsight NIBS

Contains the following products (in addition to off-the-shelf components):

Product Name: Brainsight IOBox (Model: NTB003)

Product Name: Brainsight Computer Trolley (Model: BSCT001)

Sub-System Name: MEP Pod (MEPP)

Product Name: Analog Cable HR10 (Model: ANAH001)

Product Name: Belt Isolation Unit (Model: BELT002)

Product Name: Sensor (Model: SENS003)

Product Name: Electrode (Model: ELEC001)

Component License agreements

Brainsight 2 employs several open-source components and we have contributed to many of these through the development and testing of new features (both automated and manual). The license agreements of each open-source components are printed here in compliance with their respective license agreements.

VTK

VTK is an open-source toolkit licensed under the BSD license.

Copyright (c) 1993-2008 Ken Martin, Will Schroeder, Bill Lorensen

All rights reserved.

Redistribution and use in source and binary forms, with or without modification, are permitted provided that the following conditions are met:

- Redistributions of source code must retain the above copyright notice, this list of conditions and the following disclaimer.
- Redistributions in binary form must reproduce the above copyright notice, this list of conditions and the following disclaimer in the documentation and/or other materials provided with the distribution.
- Neither name of Ken Martin, Will Schroeder, or Bill Lorensen nor the names of any contributors may be used to endorse or promote products derived from this software without specific prior written permission.

THIS SOFTWARE IS PROVIDED BY THE COPYRIGHT HOLDERS AND CONTRIBUTORS "AS IS" AND ANY EXPRESS OR IMPLIED WARRANTIES, INCLUDING, BUT NOT LIMITED TO, THE IMPLIED WARRANTIES OF MERCHANTABILITY AND FITNESS FOR A PARTICULAR PURPOSE ARE DISCLAIMED. IN NO EVENT SHALL THE AUTHORS OR CONTRIBUTORS BE LIABLE FOR ANY DIRECT, INDIRECT, INCIDENTAL, SPECIAL, EXEMPLARY, OR CONSEQUENTIAL DAMAGES (INCLUDING, BUT NOT

LIMITED TO, PROCUREMENT OF SUBSTITUTE GOODS OR SERVICES; LOSS OF USE, DATA, OR PROFITS; OR BUSINESS INTERRUPTION) HOWEVER CAUSED AND ON ANY THEORY OF LIABILITY, WHETHER IN CONTRACT, STRICT LIABILITY, OR TORT (INCLUDING NEGLIGENCE OR OTHERWISE) ARISING IN ANY WAY OUT OF THE USE OF THIS SOFTWARE, EVEN IF ADVISED OF THE POSSIBILITY OF SUCH DAMAGE.

ITK

NumFOCUS holds the copyright of this software. NumFOCUS is a non-profit entity that promotes the use of open source scientific software for educational and research purposes. NumFOCUS delegates project governance to the Insight Software Consortium Council, an educational consortium dedicated to promoting and maintaining open-source, freely available software for medical image analysis.

The software is distributed as open source under an OSI-approved license. Starting with ITK 4.0, the Apache 2.0 license is used. For versions prior and including 3.20, the new and simplified BSD license is used. Before 3.6, a variation of the BSD license is used.

GDCM

Copyright (c) 2006-2011 Mathieu Malaterre

Copyright (c) 1993-2005 CREATIS

(CREATIS = Centre de Recherche et d'Applications en Traitement de l'Image)

All rights reserved.

Redistribution and use in source and binary forms, with or without

modification, are permitted provided that the following conditions are met:

- Redistributions of source code must retain the above copyright notice, this list of conditions and the following disclaimer.
- Redistributions in binary form must reproduce the above copyright notice, this list of conditions and the following disclaimer in the documentation and/or other materials provided with the distribution.
- Neither name of Mathieu Malaterre, or CREATIS, nor the names of any contributors (CNRS, INSERM, UCB, Universite Lyon I), may be used to endorse or promote products derived from this software without specific prior written permission.

THIS SOFTWARE IS PROVIDED BY THE COPYRIGHT HOLDERS AND CONTRIBUTORS "AS IS" AND ANY EXPRESS OR IMPLIED WARRANTIES, INCLUDING, BUT NOT LIMITED TO, THE IMPLIED WARRANTIES OF MERCHANTABILITY AND FITNESS FOR A PARTICULAR PURPOSE ARE DISCLAIMED. IN NO EVENT SHALL THE AUTHORS OR CONTRIBUTORS BE LIABLE FOR ANY DIRECT, INDIRECT, INCIDENTAL, SPECIAL, EXEMPLARY, OR CONSEQUENTIAL DAMAGES (INCLUDING, BUT NOT LIMITED TO, PROCUREMENT OF SUBSTITUTE GOODS OR SERVICES; LOSS OF USE, DATA, OR PROFITS; OR

BUSINESS INTERRUPTION) HOWEVER CAUSED AND ON ANY THEORY OF LIABILITY, WHETHER IN CONTRACT, STRICT LIABILITY, OR TORT (INCLUDING NEGLIGENCE OR OTHERWISE) ARISING IN ANY WAY OUT OF THE USE OF THIS SOFTWARE, EVEN IF ADVISED OF THE POSSIBILITY OF SUCH DAMAGE.

OpenCV

Copyright 2000-2022 Intel Corporation, OpenCV Foundation, and others

Licensed under the Apache License, Version 2.0 (the "License"); you may not use this file except in compliance with the License.

You may obtain a copy of the License at

<http://www.apache.org/licenses/LICENSE-2.0>

Unless required by applicable law or agreed to in writing, software distributed under the License is distributed on an "AS IS" BASIS, WITHOUT WARRANTIES OR CONDITIONS OF ANY KIND, either express or implied. See the License for the specific language governing permissions and limitations under the License.

AMSerialPort

Copyright © 2009, Andreas Mayer

All rights reserved.

Redistribution and use in source and binary forms, with or without modification, are permitted provided that the following conditions are met:

- Redistributions of source code must retain the above

copyright notice, this list of conditions and the following disclaimer.

- Redistributions in binary form must reproduce the above copyright notice, this list of conditions and the following disclaimer in the documentation and/or other materials provided with the distribution.

- Neither the name of Andreas Mayer nor the names of its contributors may be used to endorse or promote products derived from this software without specific prior written permission.

THIS SOFTWARE IS PROVIDED BY THE COPYRIGHT HOLDERS AND CONTRIBUTORS "AS IS" AND ANY EXPRESS OR IMPLIED WARRANTIES, INCLUDING, BUT NOT LIMITED TO, THE IMPLIED WARRANTIES OF MERCHANTABILITY AND FITNESS FOR A PARTICULAR PURPOSE ARE DISCLAIMED. IN NO EVENT SHALL THE COPYRIGHT HOLDER OR CONTRIBUTORS BE LIABLE FOR ANY DIRECT, INDIRECT, INCIDENTAL, SPECIAL, EXEMPLARY, OR CONSEQUENTIAL DAMAGES (INCLUDING, BUT NOT LIMITED TO, PROCUREMENT OF SUBSTITUTE GOODS OR SERVICES; LOSS OF USE, DATA, OR PROFITS; OR BUSINESS INTERRUPTION) HOWEVER CAUSED AND ON ANY THEORY OF LIABILITY, WHETHER IN CONTRACT, STRICT LIABILITY, OR TORT (INCLUDING NEGLIGENCE OR OTHERWISE) ARISING IN ANY WAY OUT OF THE USE OF THIS SOFTWARE, EVEN IF ADVISED OF THE POSSIBILITY OF SUCH DAMAGE.

Remote Control Wrapper

Copyright (c) 2006-2014 Martin Kahr

MIT Style License

Permission is hereby granted, free of charge, to any person obtaining a copy of this software and associated documentation files (the "Software"), to deal in the Software without restriction, including without limitation the rights to use, copy, modify, merge, publish, distribute, sublicense, and/or sell copies of the Software, and to permit persons to whom the Software is furnished to do so, subject to the following conditions:

The above copyright notice and this permission notice shall be included in all copies or substantial portions of the Software.

THE SOFTWARE IS PROVIDED "AS IS", WITHOUT WARRANTY OF ANY KIND, EXPRESS OR IMPLIED, INCLUDING BUT NOT LIMITED TO THE WARRANTIES OF MERCHANTABILITY, FITNESS FOR A PARTICULAR PURPOSE AND NONINFRINGEMENT. IN NO EVENT SHALL THE AUTHORS OR COPYRIGHT HOLDERS BE LIABLE FOR ANY CLAIM, DAMAGES OR OTHER LIABILITY, WHETHER IN AN ACTION OF CONTRACT, TORT OR OTHERWISE, ARISING FROM, OUT OF OR IN CONNECTION WITH THE SOFTWARE OR THE USE OR OTHER DEALINGS IN THE SOFTWARE.

FeedbackReporter

Copyright 2008-2019 Torsten Curdt

Licensed under the Apache License, Version 2.0 (the "License"); you may not use this file except in compliance with the License.

You may obtain a copy of the License at

<http://www.apache.org/licenses/LICENSE-2.0>

Unless required by applicable law or agreed to in writing, software distributed under the License is distributed on an "AS IS" BASIS, WITHOUT WARRANTIES OR CONDITIONS OF ANY KIND, either express or implied. See the License for the specific language governing permissions and limitations under the License.

libusb

GNU LESSER GENERAL PUBLIC LICENSE (LGPL) 2.1

GNU LESSER GENERAL PUBLIC LICENSE TERMS AND CONDITIONS FOR COPYING, DISTRIBUTION AND MODIFICATION

0. This License Agreement applies to any software library or other program which contains a notice placed by the copyright holder or other authorized party saying it may be distributed under the terms of this Lesser General Public License (also called "this License").

Each licensee is addressed as "you".

A "library" means a collection of software functions and/or data prepared so as to be conveniently linked with application programs (which use some of those functions and data) to form executables.

The "Library", below, refers to any such software library or work which has been distributed under these terms. A "work based on the Library" means either the Library or any derivative work under copyright law: that is to

say, a work containing the Library or a portion of it, either verbatim or with modifications and/or translated straightforwardly into another language. (Hereinafter, translation is included without limitation in the term "modification".)

"Source code" for a work means the preferred form of the work for making modifications to it. For a library, complete source code means all the source code for all modules it contains, plus any associated interface definition files, plus the scripts used to control compilation and installation of the library.

Activities other than copying, distribution and modification are not covered by this License; they are outside its scope. The act of running a program using the Library is not restricted, and output from such a program is covered only if its contents constitute a work based on the Library (independent of the use of the Library in a tool for writing it). Whether that is true depends on what the Library does and what the program that uses the Library does.

1. You may copy and distribute verbatim copies of the Library's complete source code as you receive it, in any medium, provided that you conspicuously and appropriately publish on each copy an appropriate copyright notice and disclaimer of warranty; keep intact all the notices that refer to this License and to the absence of any warranty; and distribute a copy of this License along with the Library.

You may charge a fee for the physical act of transferring

a copy, and you may at your option offer warranty protection in exchange for a fee.

2. You may modify your copy or copies of the Library or any portion of it, thus forming a work based on the Library, and copy and distribute such modifications or work under the terms of Section 1 above, provided that you also meet all of these conditions:

- a) The modified work must itself be a software library.
- b) You must cause the files modified to carry prominent notices stating that you changed the files and the date of any change.
- c) You must cause the whole of the work to be licensed at no charge to all third parties under the terms of this License.
- d) If a facility in the modified Library refers to a function or a table of data to be supplied by an application program that uses the facility, other than as an argument passed when the facility is invoked, then you must make a good faith effort to ensure that, in the event an application does not supply such function or table, the facility still operates, and performs whatever part of its purpose remains meaningful. (For example, a function in a library to compute square roots has a purpose that is entirely well-defined independent of the application. Therefore, Subsection 2d requires that any application-supplied function or table used by this function must be optional: if the application does not supply it, the square root function must still compute square roots.)

These requirements apply to the modified work as a whole. If identifiable sections of that work are not derived from the Library, and can be reasonably considered independent and separate works in themselves, then this License, and its terms, do not apply to those sections when you distribute them as separate works. But when you distribute the same sections as part of a whole which is a work based on the Library, the distribution of the whole must be on the terms of this License, whose permissions for other licensees extend to the entire whole, and thus to each and every part regardless of who wrote it. Thus, it is not the intent of this section to claim rights or contest your rights to work written entirely by you; rather, the intent is to exercise the right to control the distribution of derivative or collective works based on the Library.

In addition, mere aggregation of another work not based on the Library with the Library (or with a work based on the Library) on a volume of a storage or distribution medium does not bring the other work under the scope of this License.

3. You may opt to apply the terms of the ordinary GNU General Public License instead of this License to a given copy of the Library. To do this, you must alter all the notices that refer to this License, so that they refer to the ordinary GNU General Public License, version 2, instead of to this License. (If a newer version than version 2 of the ordinary GNU General Public License has appeared, then you can specify that version instead if you wish.) Do

not make any other change in these notices.

Once this change is made in a given copy, it is irreversible for that copy, so the ordinary GNU General Public License applies to all subsequent copies and derivative works made from that copy.

This option is useful when you wish to copy part of the code of the Library into a program that is not a library.

4. You may copy and distribute the Library (or a portion or derivative of it, under Section 2) in object code or executable form under the terms of Sections 1 and 2 above provided that you accompany it with the complete corresponding machine-readable source code, which must be distributed under the terms of Sections 1 and 2 above on a medium customarily used for software interchange.

If distribution of object code is made by offering access to copy from a designated place, then offering equivalent access to copy the source code from the same place satisfies the requirement to distribute the source code, even though third parties are not compelled to copy the source along with the object code.

5. A program that contains no derivative of any portion of the Library, but is designed to work with the Library by being compiled or linked with it, is called a “work that uses the Library”. Such a work, in isolation, is not a derivative work of the Library, and therefore falls outside the scope of this License.

However, linking a “work that uses the Library” with

the Library creates an executable that is a derivative of the Library (because it contains portions of the Library), rather than a “work that uses the library”. The executable is therefore covered by this License. Section 6 states terms for distribution of such executables.

When a “work that uses the Library” uses material from a header file that is part of the Library, the object code for the work may be a derivative work of the Library even though the source code is not. Whether this is true is especially significant if the work can be linked without the Library, or if the work is itself a library. The threshold for this to be true is not precisely defined by law. If such an object file uses only numerical parameters, data structure layouts and accessors, and small macros and small inline functions (ten lines or less in length), then the use of the object file is unrestricted, regardless of whether it is legally a derivative work. (Executables containing this object code plus portions of the Library will still fall under Section 6.) Otherwise, if the work is a derivative of the Library, you may distribute the object code for the work under the terms of Section 6. Any executables containing that work also fall under Section 6, whether or not they are linked directly with the Library itself.

6. As an exception to the Sections above, you may also combine or link a “work that uses the Library” with the Library to produce a work containing portions of the Library, and distribute that work under terms of your choice, provided that the terms permit modification of the work for the customer’s own use and reverse engineering

for debugging such modifications. You must give prominent notice with each copy of the work that the Library is used in it and that the Library and its use are covered by this License. You must supply a copy of this License. If the work during execution displays copyright notices, you must include the copyright notice for the Library among them, as well as a reference directing the user to the copy of this License. Also, you must do one of these things:

a) Accompany the work with the complete corresponding machine-readable source code for the Library including whatever changes were used in the work (which must be distributed under Sections 1 and 2 above); and, if the work is an executable linked with the Library, with the complete machine-readable “work that uses the Library”, as object code and/or source code, so that the user can modify the Library and then relink to produce a modified executable containing the modified Library. (It is understood that the user who changes the contents of definitions files in the Library will not necessarily be able to recompile the application to use the modified definitions.)

b) Use a suitable shared library mechanism for linking with the Library. A suitable mechanism is one that (1) uses at run time a copy of the library already present on the user’s computer system, rather than copying library functions into the executable, and (2) will operate properly with a modified version of the library, if the user installs one, as long as the modified version is interface-compatible with the version that the work

was made with.

c) Accompany the work with a written offer, valid for at least three years, to give the same user the materials specified in Subsection 6a, above, for a charge no more than the cost of performing this distribution.

d) If distribution of the work is made by offering access to copy from a designated place, offer equivalent access to copy the above specified materials from the same place.

e) Verify that the user has already received a copy of these materials or that you have already sent this user a copy. For an executable, the required form of the “work that uses the Library” must include any data and utility programs needed for reproducing the executable from it. However, as a special exception, the materials to be distributed need not include anything that is normally distributed (in either source or binary form) with the major components (compiler, kernel, and so on) of the operating system on which the executable runs, unless that component itself accompanies the executable.

It may happen that this requirement contradicts the license restrictions of other proprietary libraries that do not normally accompany the operating system. Such a contradiction means you cannot use both them and the Library together in an executable that you distribute.

7. You may place library facilities that are a work based on the Library side-by-side in a single library together with other library facilities not covered by this License,

and distribute such a combined library, provided that the separate distribution of the work based on the Library and of the other library facilities is otherwise permitted, and provided that you do these two things:

a) Accompany the combined library with a copy of the same work based on the Library, uncombined with any other library facilities. This must be distributed under the terms of the Sections above.

b) Give prominent notice with the combined library of the fact that part of it is a work based on the Library, and explaining where to find the accompanying uncombined form of the same work.

8. You may not copy, modify, sublicense, link with, or distribute the Library except as expressly provided under this License. Any attempt otherwise to copy, modify, sublicense, link with, or distribute the Library is void, and will automatically terminate your rights under this License. However, parties who have received copies, or rights, from you under this License will not have their licenses terminated so long as such parties remain in full compliance.

9. You are not required to accept this License, since you have not signed it. However, nothing else grants you permission to modify or distribute the Library or its derivative works. These actions are prohibited by law if you do not accept this License. Therefore, by modifying or distributing the Library (or any work based on the Library), you indicate your acceptance of this License

to do so, and all its terms and conditions for copying, distributing or modifying the Library or works based on it.

10. Each time you redistribute the Library (or any work based on the Library), the recipient automatically receives a license from the original licensor to copy, distribute, link with or modify the Library subject to these terms and conditions. You may not impose any further restrictions on the recipients' exercise of the rights granted herein. You are not responsible for enforcing compliance by third parties with this License.

11. If, as a consequence of a court judgment or allegation of patent infringement or for any other reason (not limited to patent issues), conditions are imposed on you (whether by court order, agreement or otherwise) that contradict the conditions of this License, they do not excuse you from the conditions of this License. If you cannot distribute so as to satisfy simultaneously your obligations under this License and any other pertinent obligations, then as a consequence you may not distribute the Library at all. For example, if a patent license would not permit royalty-free redistribution of the Library by all those who receive copies directly or indirectly through you, then the only way you could satisfy both it and this License would be to refrain entirely from distribution of the Library.

If any portion of this section is held invalid or unenforceable under any particular circumstance, the balance of the section is intended to apply, and the section as a whole is intended to apply in other circumstances. It is

not the purpose of this section to induce you to infringe any patents or other property right claims or to contest validity of any such claims; this section has the sole purpose of protecting the integrity of the free software distribution system which is implemented by public license practices. Many people have made generous contributions to the wide range of software distributed through that system in reliance on consistent application of that system; it is up to the author/donor to decide if he or she is willing to distribute software through any other system and a licensee cannot impose that choice.

This section is intended to make thoroughly clear what is believed to be a consequence of the rest of this License.

12. If the distribution and/or use of the Library is restricted in certain countries either by patents or by copyrighted interfaces, the original copyright holder who places the Library under this License may add an explicit geographical distribution limitation excluding those countries, so that distribution is permitted only in or among countries not thus excluded. In such case, this License incorporates the limitation as if written in the body of this License.

13. The Free Software Foundation may publish revised and/or new versions of the Lesser General Public License from time to time. Such new versions will be similar in spirit to the present version, but may differ in detail to address new problems or concerns. Each version is given a distinguishing version number. If the Library specifies a version number of this License which applies to it and

“any later version”, you have the option of following the terms and conditions either of that version or of any later version published by the Free Software Foundation. If the Library does not specify a license version number, you may choose any version ever published by the Free Software Foundation.

14. If you wish to incorporate parts of the Library into other free programs whose distribution conditions are incompatible with these, write to the author to ask for permission. For software which is copyrighted by the Free Software Foundation, write to the Free Software Foundation; we sometimes make exceptions for this. Our decision will be guided by the two goals of preserving the free status of all derivatives of our free software and of promoting the sharing and reuse of software generally.

NO WARRANTY

15. BECAUSE THE LIBRARY IS LICENSED FREE OF CHARGE, THERE IS NO WARRANTY FOR THE LIBRARY, TO THE EXTENT PERMITTED BY APPLICABLE LAW. EXCEPT WHEN OTHERWISE STATED IN WRITING THE COPYRIGHT HOLDERS AND/OR OTHER PARTIES PROVIDE THE LIBRARY “AS IS” WITHOUT WARRANTY OF ANY KIND, EITHER EXPRESSED OR IMPLIED, INCLUDING, BUT NOT LIMITED TO, THE IMPLIED WARRANTIES OF MERCHANTABILITY AND FITNESS FOR A PARTICULAR PURPOSE. THE ENTIRE RISK AS TO THE QUALITY AND PERFORMANCE OF THE LIBRARY IS WITH YOU. SHOULD THE LIBRARY PROVE DEFECTIVE, YOU ASSUME THE COST OF ALL NECESSARY SERVICING, REPAIR OR

CORRECTION.

16. IN NO EVENT UNLESS REQUIRED BY APPLICABLE LAW OR AGREED TO IN WRITING WILL ANY COPYRIGHT HOLDER, OR ANY OTHER PARTY WHO MAY MODIFY AND/OR REDISTRIBUTE THE LIBRARY AS PERMITTED ABOVE, BE LIABLE TO YOU FOR DAMAGES, INCLUDING ANY GENERAL, SPECIAL, INCIDENTAL OR CONSEQUENTIAL DAMAGES ARISING OUT OF THE USE OR INABILITY TO USE THE LIBRARY (INCLUDING BUT NOT LIMITED TO LOSS OF DATA OR DATA BEING RENDERED INACCURATE OR LOSSES SUSTAINED BY YOU OR THIRD PARTIES OR A FAILURE OF THE LIBRARY TO OPERATE WITH ANY OTHER SOFTWARE), EVEN IF SUCH HOLDER OR OTHER PARTY HAS BEEN ADVISED OF THE POSSIBILITY OF SUCH DAMAGES.

Labjack exodriver

All exodriver library and example source code are licensed under MIT X11.

Copyright (c) 2009 LabJack Corporation <support@labjack.com>

Permission is hereby granted, free of charge, to any person obtaining a copy of this software and associated documentation files (the "Software"), to deal in the Software without restriction, including without limitation the right to use, copy, modify, merge, publish, distribute, sublicense, and/or sell copies of the Software, and to permit persons to whom the Software is furnished to do so, subject to the following conditions:

The above copyright notice and this permission notice shall be included in all copies or substantial portions of the Software.

THE SOFTWARE IS PROVIDED "AS IS", WITHOUT WARRANTY OF ANY KIND, EXPRESS OR IMPLIED, INCLUDING BUT NOT LIMITED TO THE WARRANTIES OF MERCHANTABILITY, FITNESS FOR A PARTICULAR PURPOSE AND NONINFRINGEMENT. IN NO EVENT SHALL THE AUTHORS OR COPYRIGHT HOLDERS BE LIABLE FOR ANY CLAIM, DAMAGES OR OTHER LIABILITY, WHETHER IN AN ACTION OF CONTRACT, TORT OR OTHERWISE, ARISING FROM, OUT OF OR IN CONNECTION WITH THE SOFTWARE OR THE USE OR OTHER DEALINGS IN THE SOFTWARE.

```
# CocoaAsyncSocket
```

This class is in the public domain.

Originally created by Robbie Hanson in Q3 2010.
Updated and maintained by Deusty LLC and the Apple development community.

```
# Quesa
```

Quesa is distributed under the BSD License and is Copyright © 1999-2005, Quesa Developers. For some background information about this license, you may wish to visit this web site.

The BSD license allows you to link Quesa into your software, as either a static or dynamic library, with no obligation. You may not redistribute Quesa without

preserving its copyright statement.

Although not a requirement, we would prefer that any local customisations you make to Quesa are made available to the project. This ensures that your changes are carried forward into future releases of Quesa, and will be maintained as part of normal development.

Redistribution and use in source and binary forms, with or without modification, are permitted provided that the following conditions are met:

- Redistributions of source code must retain the above copyright notice, this list of conditions and the following disclaimer.
- Redistributions in binary form must reproduce the above copyright notice, this list of conditions and the following disclaimer in the documentation and/or other materials provided with the distribution.
- Neither the name of Quesa nor the names of its contributors may be used to endorse or promote products derived from this software without specific prior written permission.

THIS SOFTWARE IS PROVIDED BY THE COPYRIGHT HOLDERS AND CONTRIBUTORS "AS IS" AND ANY EXPRESS OR IMPLIED WARRANTIES, INCLUDING, BUT NOT LIMITED TO, THE IMPLIED WARRANTIES OF MERCHANTABILITY AND FITNESS FOR A PARTICULAR PURPOSE ARE DISCLAIMED. IN NO EVENT SHALL

THE COPYRIGHT OWNER OR CONTRIBUTORS BE LIABLE FOR ANY DIRECT, INDIRECT, INCIDENTAL, SPECIAL, EXEMPLARY, OR CONSEQUENTIAL DAMAGES (INCLUDING, BUT NOT LIMITED TO, PROCUREMENT OF SUBSTITUTE GOODS OR SERVICES; LOSS OF USE, DATA, OR PROFITS; OR BUSINESS INTERRUPTION) HOWEVER CAUSED AND ON ANY THEORY OF LIABILITY, WHETHER IN CONTRACT, STRICT LIABILITY, OR TORT (INCLUDING NEGLIGENCE OR OTHERWISE) ARISING IN ANY WAY OUT OF THE USE OF THIS SOFTWARE, EVEN IF ADVISED OF THE POSSIBILITY OF SUCH DAMAGE.

MNI 152 Average Brain (used in MNI-based projects)

Copyright (C) 1993–2009 Louis Collins, McConnell Brain Imaging Centre, Montreal Neurological Institute, McGill University. Permission to use, copy, modify, and distribute this software and its documentation for any purpose and without fee is hereby granted, provided that the above copyright notice appear in all copies. The authors and McGill University make no representations about the suitability of this software for any purpose. It is provided “as is” without express or implied warranty. The authors are not responsible for any data loss, equipment damage, property loss, or injury to subjects or patients resulting from the use or misuse of this software package.

Warnings and Cautions

Always connect the power cable to the Polaris optical position sensor while its power switch is OFF (or in the case of the Vicra, with the power cable un-plugged).

Failure to do so may cause serious damage to the Polaris camera.

Change Log

Note: the project file format may have changed (if migrating from 2.4 or earlier). Brainsight 2.5.x can open documents created by older versions of Brainsight, but older versions of Brainsight cannot open documents created by Brainsight 2.5.x.

Changes in version 2.5.6 (since 2.5.5): (2025-01-24)

- Brainsight can now act as a TCP/IP network server, and accept connections from one or more client applications. Clients can request that Brainsight perform certain actions, and Brainsight can inform clients when certain events occur. We provide documentation for the network communication protocol and sample Python code. (This feature requires at least macOS 10.14, and 10.15 for full functionality.)
- Oblique images (inline, inline 90, and perpendicular) use a better interpolation algorithm and thus now appear less grainy.
- Fixed a bug where long EMG channel names (from NEURO PRAX) were sometimes truncated in the legend.
- Improved error messages when connection to a network-based Polaris fails.

- Fixed miscellaneous bugs.

Changes in version 2.5.5 (since 2.5.4): (2024-11-22)

- Made substantial improvements to Vet Robot tool calibration. The workflow is mostly the same except that you no longer need to identify the tool tip and shaft in both cameras simultaneously, you can instead do so in one camera at a time, which is helpful as the camera field of view is small and it can be hard to position a tool to be visible in both simultaneously. The algorithm that calculates the tool calibration is also much improved, giving more accurate tool calibrations.
- Improved Vet Robot tool-relative movement user interface to be more intuitive, and consistently move and rotate the tool around its axes: injection/retraction, left/right, forward/backward. Previously, the behaviour was not predictable.
- Vet Robot target reachability checks now have the option of checking that not only is the target itself reachable, but that a few millimetres deeper is also reachable. A new textfield in the Perform window allows setting this amount.
- Improved Vet Robot stereo calibration for small animal systems, to better cover the cameras’ field of view.
- Fixed a rare bug where Vet Robot stereo calibration could get stuck in an infinite loop.
- When importing targets from a text file, if the

coordinate system name is set to "Relative", the positions in the file can be interpreted as relative to another (already-existing) target.

- Fixed a bug where projects based on a SimNIBS .gmsk file could get the NIFTI sform and qform confused and result in an error message when invoking BabelBrain to perform a TMS simulation.
- Fixed a bug where Polaris tool tracking could sometimes show the subject tracker move with respect to the subject's head. This was merely a visual glitch, and did not affect correctness.
- Improved performance working with many targets (example: big grids).
- Improved performance working with many electrodes (example: big EEG/NIRS caps).
- Improved performance opening .dxf files.
- The Polaris firmware version number is now shown in the Polaris Configuration window.
- In waveform views, when in staggered mode, you can now click a waveform to get a tooltip showing the channel name.
- Fixed a crash opening corrupt project files.
- Fixed a bug where recalibrating a NIRS block would program an incorrect version number into the block's memory.
- Fixed a bug where the bullseye view would show a TMS coil in the background when a fUS tool was

being used.

- Fixed a bug where the Vet Robot firmware version number would sometimes be displayed incorrectly.
- Fixed a bug where changing a sample's EMG peak-to-peak value or its "contribute" checkbox would fail to refresh the sample's colour in 2D and 3D views.
- Fixed a bug where changing the time index in a 4D overlay would sometimes fail to refresh 2D and 3D views.
- Fixed a bug where, if there were multiple surface reconstructions, changing the colour or other attribute of one would sometimes fail to refresh 3D views.
- Fixed a bug where, if there were multiple curvilinear reconstructions, changing the peel depth of one would sometimes fail to refresh 3D views.
- Fixed miscellaneous bugs.

Changes in version 2.5.4 (since 2.5.3): (2024-06-26)

- Moved some user interface controls from the bottom to the top of the window, namely the 3D Crosshairs and Driver popup buttons. This gives more vertical space for images and makes the contents of the popup menu less likely to overflow.
- Added a new option in the Trigger Options window to allow creating samples even when the relevant Polaris tools are not visible (by default samples cannot be created when, for example, the coil tracker

is not visible.)

- Now default to looking for SimNIBS 4.1 (newest at time of writing), instead of 4.0. If you have an older (or newer) version, adjust the path in Brainsight > Settings.
- Added a fourth set of tool-relative Vet Robot movement controls that only have buttons to inject and retract the tool. The controls that allow the more dangerous tool-relative rotations are now separated in a different pane.
- No longer allow Vet Robot to move to a marker-type target, only to trajectory-type targets. This is a safety precaution because, although markers technically have an orientation, it's not displayed, and so the robot risks moving in an unexpected direction.
- Fixed a bug where Vet Robot subject registration would fail if the skull reconstruction was not watertight and consisted of several disjoint pieces and one of the initial registration landmarks was touching a secondary piece.
- For Vet Robot sessions, the default threshold range in the Validation step was tightened from 0.5 to 0.3 mm, reflecting recent improvements in system accuracy.
- Made various improvements for Axilum Robot / Cobot support:
 - An error message is now shown if the Cobot is not in MCP (manual control panel) mode.

- Added functionality to switch Cobot sides.
- The force sensor check procedure must now be redone if the coil is changed.
- Coil names are now partly anonymized, to no longer reveal if a sham coil is being used (to help with blind studies).
- Extended the range of the contact sensor sensitivity.
- The Polaris Lyra is now configured to track at 30 Hz instead of 20 Hz.
- Fixed a bug where a bumps to a Polaris were not reported.
- Fixed a bug that could result in a failure to read some valid NIFTI files, for example those generated by BabelBrain.
- Fixed a bug where vector field arrows (for TMS simulation for example) sometimes did not display when then should have.
- Fixed a bug where 4D datasets with exactly 4 time components would be interpreted and drawn as vector fields.
- Added a new fUS transducer option for 3D Cross-hairs shape.
- Added a new button next to the scene selection popup menu to quickly customize a view.
- A TMS coil is no longer shown in bullseye views when the selected tool calibration is fUS-type.

- Creating a surface/skin reconstruction is now about 25% faster.
- Creating a curvilinear reconstruction is now about 35% faster.
- Fixed various crashes that could occur opening corrupt files.
- Fixed miscellaneous bugs.

Changes in version 2.5.3 (since 2.5.2): (2024-03-01)

- Brainsight can now simulate the acoustic effect of transcranial focused ultrasound (fUS) at a target location. It does this by interacting with BabelBrain, a third party software that must be installed separately. The Targets window now allows invoking BabelBrain, wherein simulation parameters can be set. The resulting simulation appears overlaid in 2D and 3D images, and can be customized from the Inspector window.
- When writing to our .txt file formats, we now use slightly different coordinate system names for NIFTI files, which may require updating code that reads these files. The coordinate system name now includes whether it's from the file's sform or qform. So, for example, where we used to use a string like "NIFTI:Scanner" we now use "NIFTI:Q:Scanner". For this reason, exported .txt files increased from version 13 to 14, and .txt files created by streaming increased from version 6 to 7.
- Improved performance when creating hundreds of

samples. There should be noticeably less latency between the trigger that creates a sample and its appearance in the application.

- Substantially improved accuracy of Vet Robot subject registration, thus improving accuracy results overall.
- Fixed a bug, introduced only in 2.5.2, where selecting two or more samples was not showing the average waveform for EEG and NIRS views (but was for EMG views).
- Fixed a bug where EMG waveform views sometimes did not show the visual indication (crosshatching) of when a waveform has exceeded the EMG pod device's maximum range of 2.25 mV.
- Fixed a bug in EMG views where the line indicating the EMG latency would sometimes not redraw after the time range was changed (with the green vertical bars).
- Fixed a bug where electrodes could still be clicked in 3D views, even when all electrodes were hidden.
- Fixed miscellaneous bugs.

Changes in version 2.5.2 (since 2.5.1): (Oct 2023)

- Added calculation and display of EMG latency using the SHTE algorithm (by Šoda, Vidaković, Lorincz, Jerković, and Vujović). The Perform and Review windows now have a new optional table column that can show the latency for each sample. In addition, waveform views now draw a vertical line at the

latency time. This line can be dragged to adjust the automatically computed value if it seems incorrect. Latency can also be exported to .txt files from the Review window.

- Each reconstruction can now be configured to participate in overlay blending or not. If the option is off, overlays will never be blended on that reconstruction. If the option is on, overlays will be blended atop that reconstruction, provided the overlay is enabled in the Inspector window (as usual). This option is on by default for curvilinear reconstructions, and off by default for surface reconstructions.
- A tool calibration's 4x4 matrix can now be exported to a MINC .xnm text file.
- The Vet Robot can now be moved relative to the currently used tool.
- The Session Polaris window now allows selecting the Polaris, and also has a button to bring up the Polaris Configuration window.
- More windows now have the option of showing the crosshair's numerical coordinates (at the bottom right).
- Fixed a bug where some projects with corrupt NIRS data would fail to load.
- Fixed a longstanding bug where the brightness/contrast slider did not work in the Curvilinear From Overlay and Surface From Overlay windows when an overlay was used as the source of the reconstruction.

- Fixed a bug where Brainsight would not automatically connect to a Polaris, even if it was detected.
- Fixed a bug where some image views would stop drawing after Brainsight was running in the background.
- Fixed a crash creating motor maps on old Macs with Nvidia GPUs .
- Improved performance creating motor maps on Macs with Apple Silicon processors.
- Fixed several crashes that could occur when opening corrupt files of various formats.
- Fixed miscellaneous bugs.

Changes in version 2.5.1 (since 2.5): (2023-06-27)

- Fixed a crash in the Tool Calibrations window when using a TTL trigger to start the calibration procedure.
- There is now a user-resizable box in the ROI window to constrain the extent of the seed flood fill.
- There is a new disc shape option for targets and samples.
- Added support for the new Polaris Lyra® position sensor.
- Fixed a bug where vector fields from SimNIBS simulations were sometimes not shown correctly in the Session Perform and Session Review windows.
- Fixed a bug where the Park and Welcome buttons

to move the Axilum robot/cobot were disabled when they shouldn't have been.

- If a sample cannot be created, a brief error message is now shown.
- Improved the robustness of the Vet Robot stereo calibration procedure.
- Fixed an error in the header comments of the stream-to-file feature.
- Fixed a bug where zooming a waveform image view sometimes did not work.
- Fixed a bug where the time index of 4D datasets was not shown correctly.
- Fixed miscellaneous bugs.

Changes in version 2.5.0 (since 2.4.11): (2022-03-24)

- Note: macOS 10.13 High Sierra is now the minimum requirement, increased from macOS 10.11 El Capitan in Brainsight 2.4. For a free update, visit <https://support.apple.com/macOS/upgrade>. Contact us if you need to upgrade your Mac hardware.
- Brainsight can now simulate the induced electric field due to a TMS stimulation at a target location. It does this by interacting with SimNIBS, a third party software that must also be installed. The Targets window now allows associating a TMS coil model and stimulation strength with each target. The resulting simulation appears overlaid in 2D and 3D images, and can be customized from the Inspector

window.

- 3D reconstructions (like the skin reconstruction) are now coloured by blending any enabled overlays atop the reconstruction's own colour.
- Overlays now support time series data (though only from NIFTI and MINC2 files, not other formats). The Overlays window and Inspector window now have a new slider to choose the time offset.
- Very large datasets (with more than 2^{31} voxels) can now be used.
- Made various accuracy improvements to Vet Robot stereo calibration and subject registration, resulting in more accurate targeting during surgery.
- In the Session Perform window, creating new samples is now disallowed if the relevant Polaris tools are not visible.
- In the Session Perform window, the 'stream to file' feature now includes EMG waveform data and the coordinate system for selected targets and created samples.
- In the Session Perform window, the 'Sample Now' button is now disabled if the required tools are not visible to the Polaris camera.
- When working with the Axilum robot/cobot, a new 'scalp offset' distance can be specified to keep the TMS coil a few millimetres above the scalp to account for the thickness of an EEG cap for example.

- EMG waveform views now visually indicate when a waveform has exceeded the EMG pod device's maximum range of 2.25 mV.
- Added support for the Cornell University (Johnson, Philippa J; Barry, Erica F) canine atlas.
- Fixed various bugs with some DICOM datasets, where images would appear split in half, have gaps, or have missing slices.
- Fixed a longstanding bug where reconstructions based on ROIs would claim that re-computation was necessary, even though the ROI hadn't changed. (This was partly fixed in 2.4, but still occurred for re-opened projects.)
- ROIs can now be created by importing from a medical image file (DICOM, NIFTI, MINC, etc.).
- Fixed a bug in the ROI window where the pencil and eraser tools would not work correctly at the edge of view, especially when moving the mouse quickly.
- NIRS waveforms can be imported from a .nirs file, thus allowing importing data from other manufacturers' NIRS devices.
- Fixed a bug (introduced in Brainsight 2.4.11) where the SD.SrcPos and SD.SrcPos3D fields in exported .nirs files were swapped.
- Fixed a bug (introduced in Brainsight 2.4.5) where the SD.SrcPos field in exported .nirs files were in decimetres instead of centimetres. (The SD.SrcPos3D field was exported correctly in millimetres though.)

- Assembly Lists and Cap Layouts can now be created by importing from a .nirs file.
- Calibrating a TMS coil or other tool now allows for the tool tracker and calibration tracker to move together (relative to the camera), instead of failing if either tool moved relative to the camera.
- Polaris tool visibility status now uses a larger coloured area, making it more visible from farther away.
- The enabled/disabled state of Polaris tools in the Polaris Configuration window are now remembered across quit/relaunch.
- Landmarks, targets, electrodes, and samples can now be clicked in 3D image views to select the corresponding item in the related table view.
- Targets can now be exported to a text file from the Targets window (export was previously possible, but only from the Session Review window).
- In the Targets window, if a reconstruction is chosen in the 'optimize traj. to' popup menu, clicking in 2D views no longer reorients crosshairs.
- Exporting curvilinear reconstructions in the PLY format now includes the voxel values in greyscale, whereas previously no colour was exported, only the shape.
- When exporting reconstructions as STL, VTK, and PLY you can now choose between the ASCII and binary variants of these file formats.

- When importing a reconstruction from file, the object can now be placed relative to a chosen target (useful for placing chambers for example).
- The crosshairs in 2D image views now have a small gap in the middle so as not to obscure the very thing being targeted.
- Wherever 4x4 matrices can be imported from a file, a new file format is now supported namely plain text files with 16 numbers within.
- The crosshairs offset slider now allows a large range.
- When opening a project file, if there are referenced external files (datasets, CAD files) that can't be found, the dialog that asks to find them now (by default) disables files with different names, thus making it much easier to find the correct file.
- A new preference allows changing the colours of the bullseye views, especially useful for colour blind users.
- A new preference allows changing the font size of the bullseye views.
- A new preference allows specifying default EMG baseline and trial durations that will be used when creating new sessions.
- Native support for Apple Silicon processors.
- Improved support for macOS 11 Big Sur, macOS 12 Monterey, and macOS 13 Ventura.

- Various performance improvements:
- Exporting DXF files is now much faster, especially for large reconstructions.
- Updating an atlas space template overlay is now much faster.
- Reorienting the anatomical dataset is now much faster.
- Creating curvilinear reconstructions is now much faster.
- Creating skin and other surface reconstructions is faster.
- Fixed miscellaneous bugs.

Changes in version 2.4.11 (since 2.4.10): (2022-07-12)

- Fixed a longstanding (but rare) crash that occurred when closing a window that contains image views.
- Fixed a bug where the name of proximity detectors was not exported correctly in .nirs files.
- Fixed a bug where macOS could warn of an expired certificate by updating our Developer ID code signing certificate.
- Updated support for newest iterations of our Vet Robot hardware, notably for the NHP 45 degree inclination setup.
- Fixed a bug where the date/time metadata from MINC1 files would sometimes not be shown.

- Improved error checking when communicating with a Magstim TMS stimulator.
- Fixed miscellaneous bugs.

Changes in version 2.4.10 (since 2.4.9): (2022-03-01)

- Fixed a crash that could occur when computing the distance from a point to a surface, which occurs in several places, like the Targets and Session windows.
- Fixed a bug where importing a dxf file resulted in the colours being read incorrectly.
- Updated support for newest iterations of our Vet Robot hardware, notably the 50 mm lens.
- Fixed a small inaccuracy in the visual positioning of an LCT (large coil tracker) object in 3D images. (This did not affect the actual measured position of the tracker.)
- Fixed miscellaneous bugs.

Changes in version 2.4.9 (since 2.4.8): (2021-10-18)

- There is a new checkbox in the Session > IOBox step to indicate if you want to save or discard the live/full EMG waveform. It's usually not necessary to save it, because samples contain a copy of the EMG waveform just before and after the TMS pulse, and as it can grow very large it slows performance, especially saving and opening project files.
- Resuming a session no longer overwrites any existing live/full EMG waveform, instead it now appends new data to the end.

- Fixed a bug where the EMG pod was sometimes not detected between closing and resuming sessions or when disconnecting and reconnecting its USB cable.
- Fixed a bug where exporting .nirs files would fail if the project did not contain any NIRS Aux data.
- When stopping an Axilum session, we now perform an extra movement to make sure the robot arm stays in the working space.
- Fixed miscellaneous bugs.

Changes in version 2.4.8 (since 2.4.7): (2021-06-25)

- The Polaris Configuration window now has a new popup menu where you can choose which Polaris device to use. This is especially useful for network-based Polaris cameras, of which you may have several on your network.
- Fixed a bug where the application would sometimes become unresponsive when communicating with a Polaris Vega.
- The 'extended pyramid' volume shape supported by some Polaris Spectra and Vega cameras is now supported and will be used automatically if available.
- Fixed a bug where the NIRS Configuration window would indicate a firmware update was available when in fact no update was available.
- The Vet Robot stereo calibration procedure was improved to capture slightly more points.

- The 'Mini TMS Coil' 3D crosshairs shape now has a slightly longer shaft.
- Fixed miscellaneous bugs.

Changes in version 2.4.7 (since 2.4.6): (2020-12-23)

- Added support for the new macOS 11 Big Sur, notably communication with Polaris cameras now works.
- Numerous changes to Axilum Robotics support:
 - A new feature in the Session Perform window now allows visiting a sequence of targets, pausing for a specified number of TMS pulses, with a specified duration between them, and then moving to the next target.
 - The "Align" buttons have changed behaviour in several notable ways:
 - They now only act on the sole selected target. They no longer can be used for a folder of targets.
 - They now move in whatever path is necessary to ultimately reach the target and always descend the coil to contact the skin. (Previously, there were two behaviours: if the coil was already on the skin, they would only try to slide along the skin, and if the target was too far, no movement would result at all. If the coil was in orbit, they would align above the new target, but not descend to the skin.)
 - To signal this behavior change, the buttons have been renamed from "Align" to "Move".

- The "Stop" button now moves the robot arm away from the subject's head, if it was in contact.
- Closing a session window now warns if you are connected to a robot, instead of just closing.
- Added tool-tips to most of the Axilum-related buttons, to help understand what they each do.
- Added a second kind of subject registration for Vet Robot sessions. Instead of using two landmarks and the laser grid, you can now use three or more landmarks for a classic rigid body registration. This requires being able to accurately locate such landmarks both on the anatomical scan and in the camera images.
- The Targets window now allows importing target names and coordinates from a text file.
- Fixed a bug where older documents sometimes failed to convert to the newest format with the message "crosshairs is a required value".
- Fixed a bug where the "switch" input on the IOBox was triggering from high to low voltage instead of low to high voltage, resulting in presses of the foot switch being recognised upon releasing the pedal instead of upon depressing the pedal.
- Fixed a crash that could occur choosing some colours in the ROI window.
- Fixed a crash importing some SPM12 .mat files.
- Fixed a crash on macOS 10.14 and older that could

occur if a TTL trigger was received while editing the peak-to-peak value in the Inspector > Motor Maps window.

- Fixed various bugs with macOS dark mode, where some things were drawn with incorrect or illegible colours.
- Fixed a bug where landmark/electrode names that contained two parts, like “LA43-LA44”, would only have the first half spoken.
- The Session Validation window now allows choosing the crosshairs shape, like most other steps in the Session window.
- Fixed an old bug where the first use of the Apple Remote after booting the Mac resulted in the first button press being reacted to twice.
- Fixed a bug where the Apple Remote up and down buttons did not work on macOS 10.13 and newer.
- Fixed a bug where the Apple Remote did not work at all on macOS 10.15 and newer.
- Fixed miscellaneous bugs.

Changes in version 2.4.6 (since 2.4.5): (2020-10-21)

- The Vet Robot subject registration procedure no longer requires manually cropping the skull reconstruction, it is now done automatically.
- Vet Robot stereo calibration and subject registration calculations are now much faster.
- Judging the quality of the Vet Robot stereo calibra-

tion procedure is now easier because we now show a graphical representation of the quality of the results.

- SPM12 .mat files can now be loaded everywhere a 4x4 matrix can be loaded from file; notably this can be used for atlas space registrations.
- When exporting .txt files from the Session Review window, the option to snap samples to a reconstruction previously only snapped inwards but now it will now snap in either direction, thus working for samples created inside the head (due to use of ‘crosshairs offset’ slider for example).
- Fixed a bug where the NEURO PRAX impedance check failed to update the electrode colours.
- Fixed miscellaneous bugs.

Changes in version 2.4.5 (since 2.4.4): (2020-06-29)

- Fixed a crash that could occur opening projects created by older versions of Brainsight, where the project once contained NIRS data that was subsequently deleted.
- Exporting .nirs files can now include the results of any analysis that was performed.
- Exported .nirs files now contain metadata indicating that centimetres are used for positional information. This will prevent Homer2 from having to ask.
- The Vet Robot Configuration window no longer shows a ring around the flange in the camera views

because the concept does not apply to the newest hardware.

- The newest version of the FTDI device driver (2.4.4) is now installed (this controls communication with RS-232 serial devices like the Polaris camera and Magstim TMS stimulator).
- Improved compatibility with macOS 10.15 Catalina by supporting ‘notarization’. This eliminates the “Brainsight can’t be opened because Apple cannot check it for malicious software” error message.
- Fixed miscellaneous bugs.

Changes in version 2.4.4 (since 2.4.3): (2020-04-09)

- Fixed a bug where the newly-released macOS Catalina 10.15.4, but not earlier versions, caused Brainsight to crash.
- Added support for the Logothetis / Saleem D99 Macaque atlas. (You also need to install Support Files Vet 1.3.)
- Fixed miscellaneous bugs.

Changes in version 2.4.3 (since 2.4.2): (2020-01-23)

- Reverted the updated FTDI device driver that was included in Brainsight 2.4.2 because it does not work correctly on newer versions of macOS. Now the same version that Brainsight 2.4.1 and earlier included is once again included.

Changes in version 2.4.2 (since 2.4.1): (2020-01-20)

- When performing coil (or tool) calibrations, relaxed

the check for how much the calibration block and tool tracker moved (it became too strict in Brainsight 2.4, resulting in calibrations sometimes failing even when the trackers were reasonably still).

- When using the 'target positioning tool', targets are once again drawn semi-transparent (this broke in Brainsight 2.3.4).
- The driver for the KeySpan USB-serial adapter is no longer installed because it does not work well with recent versions of macOS. If you have the driver already installed (from a previous version of Brainsight), it won't be uninstalled, so you can continue to use it, however, we recommend contacting us for a free replacement.
- The newest version of the FTDI device driver is now installed (this controls communication with RS-232 serial devices like the Polaris camera and Magstim TMS stimulator).
- Fixed miscellaneous bugs.

Changes in version 2.4.1 (since 2.4): (2019-12-23)

- Improved compatibility with macOS 10.15 Catalina by supporting 'notarization'. This eliminates the "Brainsight can't be opened because Apple cannot check it for malicious software" error message.
- Fixed a bug where some Analog Receivers / EMG Pods were not detected. We discovered that a

small number of such devices were not correctly programmed by us. If this is the case for your device, when you open a session window you will receive a message explaining the situation with a button to reprogram the device correctly.

- Fixed miscellaneous bugs.

Changes in version 2.4 (since 2.3.12): (2019-12-06)

- Important: Brainsight 2.4 now requires Mac OS X 10.11 (El Capitan) or newer. If your Mac is reasonably recent (~2008 or newer), you only need to update the OS, see Apple's website. If your Mac is older, it's possible you might not be able to update your OS, in which case contact Rogue Research for other upgrade options.
- Note: the project file format has changed. Brainsight 2.4 can open documents created by older versions of Brainsight, but older versions of Brainsight cannot open documents created by Brainsight 2.4.
- Added various Homer2-equivalent NIRS analysis features:
 - Support for multiple conditions.
 - Onset creation:
 - From existing samples already created in the session window.
 - By pulse detection in auxiliary data (low to high, high to low, threshold with dead time).

By manual time entry of onsets.

- Optical density calculation and visualization, both unfiltered and with low-pass, high-pass, or band-pass filtering.
- Concentration calculation and visualization of HbO, HbR, and HbT for:

Whole recording.

Block averages, with optional error bars.

Fast and easy recalculation when adding/removing onsets, changing baseline parameters, etc.

- Easy selection and visualization of NIRS data:
 - Clicking on 3D representation of optodes on subject head shows corresponding waveform data.
 - Clicking on waveform label selects corresponding optodes in 3D image views.
- Made many improvements to Vet Robot support:
 - Significantly improved the overall accuracy of the system.
 - Region painting of the skull in sessions is now both saved in the project and undoable.
 - In the Session window, camera image views can now be zoomed and panned like other views.
 - Vet Robot sessions can now be cloned.
- Made many improvements to Axilum Robotics

support:

- Added support for the Axilum Robotics TMS-Cobot.
- The skin reconstruction is now shown in the Session>Axilum step.
- Greatly improved performance of projecting targets to the skin reconstruction.
- Added support for the Polaris Vega® position sensor.
- The Session > Polaris window now shows the exact field of view shape for the Polaris Krios and Polaris Spectra, where previously it was showing the shapes of their respective predecessor models.
- Instead of a generic 'diagnostic pending' message, more exact messages are provided for various Polaris error conditions (ex: bump detected, battery fault, temperature high, etc.).
- If your Polaris' bump detector is triggered, Brainsight itself can now clear the error, obviating the need for the NDI Toolbox application.
- If the Polaris reports a dead battery or a temperature error, tool tracking will now work regardless. (You should still schedule a repair of your Polaris, as tracking accuracy may be reduced.)
- In the Session>Perform window, changing the active coil/tool calibration (from the 'driver' popup menu) now disables/enables the corresponding Polaris tools. For example, changing from a calibration that

uses CT-123 to one that uses CT-456 will stop the camera from tracking the former and start tracking the latter.

- Changed the legend in NIRS views to have a global wavelength toggle button, that applies to all pairs, instead of per-pair control of wavelength visibility.
- In 3D image views, clicking a tube that represents a NIRS pair now selects the corresponding channel in the legend of waveform views.
- Selecting a NIRS channel in the legend table or rectangles view now selects the corresponding NIRS tube in 3D image views.
- Selecting an EEG/EMG/ECG/EOG channel in the legend table now selects the corresponding electrode in 2D/3D image views.
- In sample-based waveform views, when selecting multiple samples, error bars can now optionally be shown for averages (for EEG/EMG/ECG/EOG and NIRS data).
- In sample-based waveform views, clicking a waveform now shows a tooltip that indicates which waveform the sample is from or if it is an averaged waveform.
- Waveform views now default to showing a better range of data in both the x and y axes.
- Creating an Assembly List from a .txt file now gives the option of linking it to an existing Cap Layout or creating a new Cap Layout.

- When creating a reconstruction, you can now choose to keep only the largest piece (as opposed to previously, where all pieces were kept). This can be useful for skin reconstructions, where you don't want artifacts.
- Overlays can now be configured to colour values above/below the threshold to be either transparent (as previously) or to repeat the hi/low colour of the lookup table.
- When exporting samples into DICOM files, you can now optionally project the sample along its axis to the intersection of a chosen reconstruction (ex: the brain surface).
- The 'Manual (AC-PC+scale)' atlas space window now shows resizable lines (instead of a box) to scale the template to the subject head. This better indicates how it is meant to be used.
- Added marmoset, pig, and sheep atlases.
- Added much more information to the text file streaming feature. In addition to raw Polaris tool locations that it output before, it now logs when: the selected target changes, a TTL trigger occurs, a sample is created, the crosshairs move.
- Added buttons to the Targets and Session Perform windows to navigate up/down/left/right on a rectangular grid.
- Added a button to reorient the crosshairs to be perpendicular to a chosen surface.

- All threshold sliders now have text fields below them so that exact ranges can be specified.
- Added a new preference to disable sounds played when creating samples or sampling landmarks.
- Partly fixed a longstanding bug where reconstructions based on ROIs would always claim that re-computation was necessary, even though the ROI hadn't changed. (This will still occur for re-opened projects though.)
- Fixed a long-standing but minor bug where the threshold mask in an ROI window did not exactly match the effect of flood fill.
- Fixed a long-standing bug where converting a sample to a target made all hidden targets become visible. Now the visibility of targets is unaffected.
- In an ROI window, the up and down arrow keys and up and down mouse wheel now move by exactly one slice, instead of by the 'slice increment size' of the Preferences window.
- In image views, the name of a landmark/target/sample can now be shown/hidden using a new button below the brightness/contrast slider.
- Changes to .txt format export:
 - The .txt file format has been changed from version 8 to 12 due to some minor changes to the file format. If you have scripts/code that reads such files, you may need to adjust them slightly.



- When exporting EMG data, the time range used for peak-to-peak calculations is now included.
- When exporting TMS stimulation information, the Magstim® BiStim² inter-pulse duration and second power are now included.
- Fixed a bug where Magstim® BiStim² inter-pulse duration confused μ s versus ms.
- Trackpad gestures are now supported in image views. You can now zoom with a two-finger-pinch gesture, and rotate with a two-finger-rotate gesture.
- Greatly improved performance snapping targets, grids, and electrodes to a reconstruction surface.
- Improved performance working with the Polaris.
- Improved support for non-admin macOS accounts. An admin account is still needed to install, but non-admin users can now run Brainsight.
- Improved support for macOS 10.14 Mojave and 10.15 Catalina, particularly their 'dark mode' feature.
- Fixed miscellaneous bugs.

KNOWN ISSUES:



-

SAFETY SYMBOLS

	Advice. This symbol denotes advice to obtain the best results using the system.
---	---

	Attention! This symbol denotes information regarding the safe use of the equipment to prevent injury or damage to the equipment.
	Consult User Manual

GENERAL WARNINGS

	Equipment should be used by competent personnel with technical and general neuroscience knowledge.
	The system shall be used in a professional health care or scientific research environment. It is not intended for home use.

ERROR MESSAGES

Brainsight is designed to be used trouble-free to accomplish your tasks. From time to time, Brainsight may encounter an error and report it with a message. The messages will usually include actions to take to correct or recover from the error.

Installing Brainsight and using the Polaris Camera

Error Message: "Could not get exclusivity" displayed in the Polaris status.

Description: When connecting to the Polaris Lyra or Vega via Ethernet, Brainsight expects to be able to configure the camera. If another application has already connected to the camera (e.g. NDI Tools), it may already have exclusivity.

Mitigation: Ensure no other applications are running on the Brainsight computer or any other computer sharing the networks that may connect to the Polaris camera.

Error Message: "IR Interference" displayed in the Polaris status.

Description: The Polaris camera used IR emitters and reflectors to function. Excessive stray IR from other light sources or reflection of the camera's own IR source from a reflective surface may interfere with normal operation.

Mitigation: Ensure that there are no light sources with excessive IR (including direct sunlight), mirrors or windows in the camera's line of sight. Review "Verify Proper Polaris Location" on page 118 for more assistance.

Error Message: "Temperature Low" or "Temperature out of Range"

Description: When the 3D camera is first turns on, it may require a few minutes to reach thermal stability and will not track. Until it reaches stability, it will not track and return a temperature low message. Alternatively if the camera experiences an overhead condition, either because of the environment or a failure of the camera, it will emit an out of range error.

Mitigation: If the error is a low temperature, wait 1-5 minutes for the camera to warm up. If it persists, contact Rogue Research for assistance. If the camera emits an out of range error, ensure that the camera is in a room that is within its allowable range and that it is not close to a heat source. Contact Rogue Research for assistance.

Calibrating Your Tool

Error Message: "No Trigger Box Hardware Found"

Description: When enabling the "Use I/O Box switch" to use the foot switch to initiate the tool calibration, this error will appear if the I/O box was not available. Possible causes include no I/O box present, poor USB cable connection between the Brainsight computer and I/O box, another window is already using the switch (e.g. you already have a data gathering session in progress and the I/O box was configured for the session).

Mitigation: Verify that you do not have a second window open that is using the I/O box (e.g. session perform window). Verify the USB cable connection between the Brainsight computer and I/O box. Contact Rogue Research for additional assistance.

Loading Anatomical Images

Error Message: "The specified file can't be resolved."

Description: Brainsight was unable to interpret the image data. The data may not be properly formed, or in a format Brainsight does not support.

Mitigation: Verify that the images are properly formed

and in a format supported by Brainsight as described in "Loading Anatomical Images" on page 61.

Error Message: "The file <NAME> can't be opened."

Description: Brainsight expects a properly formatted file. The error message will be accompanied by additional text identifying the file format of the target file.

Mitigation: Verify that the image file conforms to the file standards associated with the file format. Contact Rogue Research for additional assistance.

Error Message: "The anatomical data set cannot be changed because it is being used."

Description: You have loaded an anatomical image data set and have already performed operations that depend on the data set, including generating 3D reconstructions and have tried to load a different anatomical data set that is different. This cannot be done as the data set cannot be changed once it was used for additional operations.

Mitigation: If you wish to use a different anatomical data set, create a new Brainsight project using that other data set.

Error Message: "This project cannot be opened because it was created with a newer version of Brainsight."

Description: When a Brainsight project that was created or last saved using an older version of Brainsight, that project file may be updated to conform to the newer version of Brainsight. Once migrated, it will no longer be compatible with older versions of Brainsight.

Mitigation: Update the older Brainsight software to one that is compatible with the newer project. Alternatively, open the project using the newer Brainsight (i.e., the one that was used to save the project) and export the relevant session data to text file for review using other software.

Error Message: "The data set <NAME> could not be opened because it is not the expected size."

Description: If you have moved the Brainsight project and/or the image data used by the project, you may be prompted to re-select the image data at the new location. When this occurs, Brainsight will verify that the image dimensions match those that were used and report any discrepancy.

Mitigation: Verify that the images you are selecting are the same images as previously used.

Error Message: "The selected data set cannot be used because it has missing data."

Description: If you have moved the Brainsight project and/or the image data used by the project and some image files are no longer present, Brainsight will be unable to load the project.

Mitigation: Verify that they are no missing images (e.g. DICOM slices) in the image folder.

3D Reconstruction

Error Message: "The CAD file <NAME> can't be opened because it is either an unsupported format or corrupted file."

Description: Brainsight encountered an error trying to open and parse the CAD file.

Mitigation: Ensure that the file conforms to the standard associated with that file format and that the file is not damaged/corrupted. Contact Rogue Research for additional assistance.

Error Message: "The curvilinear reconstruction could not be created."

Description: Brainsight uses an internal algorithm to automatically generate the curvilinear reconstruction. This algorithm can fail for a number of reasons including poor image contrast or the presence of significant pathology.

Mitigation: Follow the instructions outlined in "Creating a curvilinear reconstruction of the full brain" on page 84 or additionally "Creating a curvilinear brain reconstruction using a model shape" on page 86.

Selecting Anatomical Landmarks

Error Message: "Do you really want to place a new landmark so close to the existing landmark named <NAME>?"

Description: When creating landmarks for the subject->Image registration, they are expected to be relatively far apart (e.g. left/right ear, nasion). When placing two landmarks close to each other (<5mm), it is often due to inadvertently placing the cursor near the previous

landmark, or clicking the landmark twice without moving the cursor after recording the previous one.

Mitigation: Ensure that the cursor is at the location of the desired new landmark before clicking new button.

Chapter 1: Introduction

Welcome to Brainsight! Brainsight represents the fruition of many years of effort in design and development. Brainsight 2.5 represents the latest installment in feature additions to the Brainsight 2 core. We hope that you find this new generation of neuronavigation tools useful, and as always, we value your feedback.

HOW THIS DOCUMENT IS ORGANIZED

This document is intended to give you all the information you need to take advantage of all the features of Brainsight 2.5. The overall structure is designed to present the information in the same logical order as you would need it in the normal use of the system. There are occasions where some background information that will be useful throughout the document will be presented. These will be given in the first place where they will be needed, and usually highlighted by being in a grey box.

Document formatting

In numerous places, you will be instructed to select menu items, or click on buttons. Rather than describing these in a “long winded ” way (e.g. “select Open... from the File menu”, or “click on the OK button”), a more concise shorthand will be used. For example, “select **File->Open**” will be used for menu selection and “click **OK**” will be used for button clicks.

THIS USED TO BE CALLED BRAINSIGHT TMS, OR BRAINSIGHT 2 TMS?

Brainsight 1 was introduced in 2000 and Brainsight 2 several years later. Back then, the main applications were for TMS (human) and veterinary surgery. We later added NIRS with the introduction of Brainsight NIRS and most of the time, these applications were performed by separate users for separate applications. Today, we have seen more applications in neuromodulation that include focused ultrasound (fUS) as well as transcranial electrical

stimulation (tES). Brainsight is evolving to better support these new applications so it seemed fitting to rename Brainsight TMS to Brainsight NIBS (despite being VERY easy to confuse with Brainsight NIRS!). For those who have read earlier versions of this manual, we are also gradually dropping the "2" when referring to Brainsight since Brainsight 1 has long since retired so referring to Brainsight 2 specifically is becoming like referring to a car as a horseless carriage. We will continue to use the version number to refer to a specific release (e.g. 2.5 vs 2.4).

SYSTEM REQUIREMENTS

Brainsight 2.5 requires a recent Macintosh computer with the following minimum characteristics:

- Mac OS X 10.13 or greater
- Intel or Apple Mx CPU
- 8 GB RAM (16+ recommended)

If you are contemplating a new computer purchase, we recommend a computer with the latest Apple M-series CPU at least 32GB RAM to ensure that the computer will be useful for a long time.

HOW TO GET HELP (or HOW YOU CAN HELP US MAKE BRAINSIGHT BETTER FOR YOU)

Brainsight 2 was designed and developed using high standards in product planning, software coding and testing. It is our expectation that on the whole, the software will work without major issues, however, you

may use Brainsight in ways that we did not foresee, and encounter new issues. You can provide us with valuable feedback in the following ways:

- **Automated crash reporting**

If Brainsight 2 crashes ("Quit unexpectedly", or "Quit while unresponsive"), a message will appear after the crash to send info to Apple. Please use this, however only Apple gets that message and is useful if the crash was caused by the OS. When you restart Brainsight, a second crash reporter will appear that allows you to send the report directly to us. The second reporter will include a screen with an error message and a record of what the software was doing when it crashed. Please add a brief description of what you were doing, and any information that you think might be helpful to us to reproduce the event. Finally click on the **Send to Rogue Research** button. Several team members will receive an e-mail alert and will act on it quickly. No personal information (other than the IP address of your computer) is included, so if you want us to follow-up with you regarding the crash, please include your name and e-mail in the comments, or send us an e-mail (so we know who to contact).

While Brainsight is running, help can be obtained from the help menu. It contains a link to a PDF version of the user manual, which is always up to date, and shortcuts to our support e-mail address.

- **email support@rogue-research.com.**

As with the crash reporter, several experienced people (the engineers that actually develop Brainsight) get the support e-mail so you should get a reply as soon as possible from someone who can help out in a meaningful way.

If you are a Brainsight 1 user, your current version 1.x software licence key (serial number) **will not be able** to enable the functionality of Brainsight 2. Rogue Research has adopted a new serial number scheme for Brainsight 2. For upgrade information, please contact us at info@rogue-research.com.

Note: If you are using a beta or a trial version, it will have an expiry date. After it expires, you will still be able to load projects and view your data and perform 3D reconstructions, but you will not be able to calibrate coils or perform TMS sessions. In the case of a beta version, a newer one will have already been released for you to download. If it was a trial version, contact us (info@rogue-research.com) for upgrade information.

Chapter 2: The Gen 1 Trolley with Vicra or Vega

The Brainsight computer trolley is designed to provide a large screen computer, required input/output ports as well as an optional integrated 2 channel EMG device in a small footprint, mobile platform. This chapter will focus on the computer and trolley. For EMG assembly and usage instructions, please refer to "Chapter 4: EMG Pod" on page 29

The mobile computer (Fig. 2-1) consists of three main parts: the computer, the trolley itself, and the I/O box. Some early versions of the trolley did not have an I/O box. We intend to upgrade all of the trolleys to the same I/O box in the near future. Please contact us to arrange the upgrade.

COMPUTER

The computer is an iMac (24" or 27" screen, depending on the purchase date) with an Intel processor. It is mounted to the trolley via three fixation screws that screw the base of the computer to the top of the trolley, or by a base platform, that itself is screwed to the cart via the three fixation screws.

TROLLEY

The trolley allows you to move the computer anywhere you need it. The keyboard and screen's height can be adjusted by pushing the foot pedal at the base of the trolley, and lifting/pushing the computer up or down.

I/O BOX

The current I/O box (Fig. 2-2) contains a power bar, cabling and the acquisition device that serves to monitor the TTL and switch interface as well as provide the analog inputs for our 2-channel EMG device. The box has a rear panel that provides the BNC interface jacks for the TTL trigger in and the foot switch (or hand switch), the



Fig. 2-1
Overall picture of the computer/trolley.

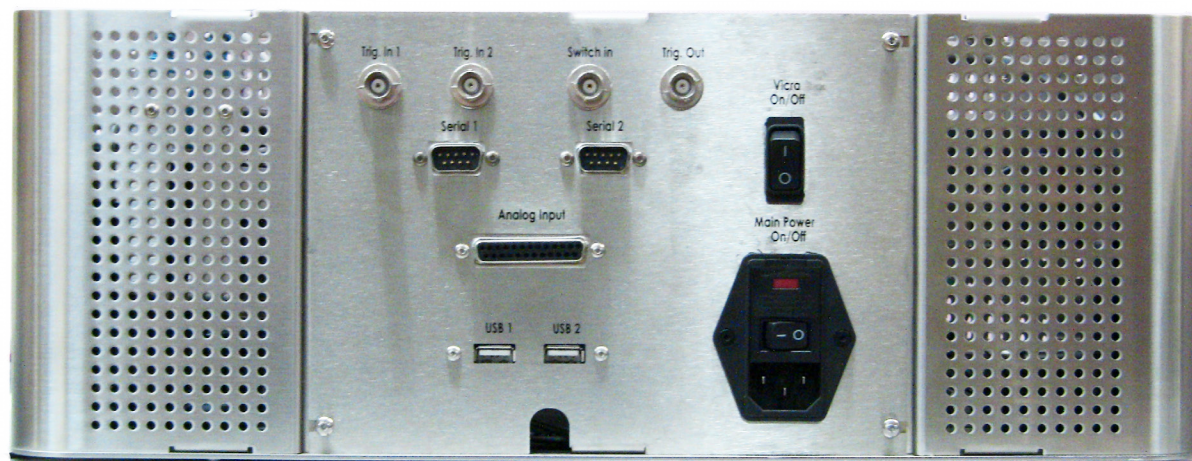

Fig. 2-2
Close-up of the rear panel of the I/O box.

analog input connector, the mains switch and the Vicra power switch..

The Vicra switch also allows you to turn the Vicra on or off without affecting the computer to allow you to use the computer for project preparation or data analysis without needing to have the Vicra on.

ASSEMBLY INSTRUCTIONS

Parts:

- Trolley Wheel Base
- Main Tube
- Foot Pedal
- Keyboard tray
- Trolley handle kit (handle, front bracket, 2 insert brackets)
- Computer base
- I/O box
- 2x hex bolts w. yellow threadlock (usually on the bottom of the Main Tube.
- 2x hex bolts w. blue thread lock
- 2x hex bolts (longer)
- 3x counter-sink hex headed screws
- White Power Cable
- Medical grade power cable
- 2x 2m USB cable
- 2x long cable-tie

- 6x short cable tie
- 1x 3/16" hex key
- 1x hex key (bronze)

Tools required:

- #2 Phillips (star) screwdriver
- Scissors or cutters for cable-ties

Instructions

1. Unpack all parts and make sure they are in good condition.

2. Place a piece of flat "bubble-wrap" material on the floor, and place the I/O box on it upside down to expose the mounting holes.
3. Place the trolley wheel base upside down on the I/O box, and carefully align the holes in the wheel base to the holes in the I/O box as illustrated in Fig. 2-3.
4. Insert the two hex bolts into the holes of the wheelbase and carefully tighten the bolts to secure the I/O box to the wheelbase using your fingers first, then with the included hex key. Take care to ensure that the bolts are straight in the mounting holes of

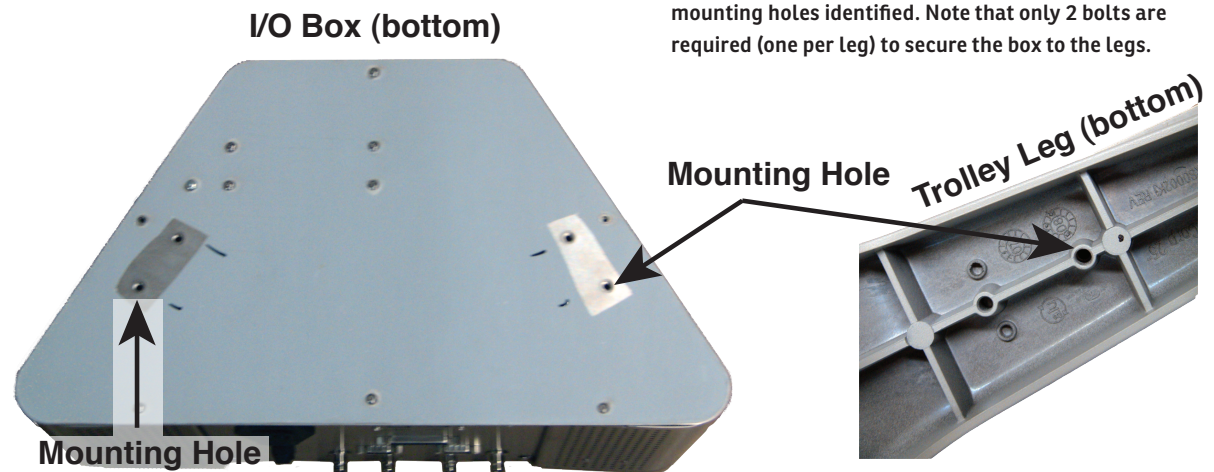
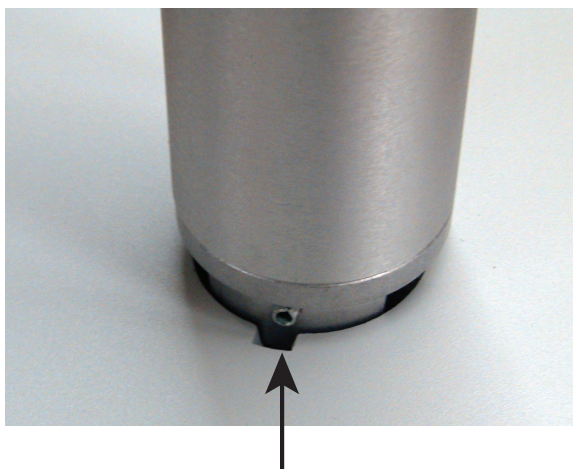

Fig. 2-3

I/O box and trolley leg, seen from underneath with the mounting holes identified. Note that only 2 bolts are required (one per leg) to secure the box to the legs.

- the I/O box and carefully tighten the bolts (if the bolt goes in crooked, the threads will strip).
5. Flip the wheelbase back upright.
 6. If present, remove the two hex bolts (yellow thread-lock) from the bottom of the main tube.
 7. Fit the main tube into the hole in the middle of the wheelbase, taking care to align the tab of the main tube with the notch in the wheelbase.
 8. Carefully tilt the wheel base/tube onto its side to expose the bottom, while keeping the tube in the hole (you may need an assistant for this step).



Alignment Pin

Fig. 2-4

Pole in the receptacle in the base. Note the alignment pin on the pole and the slot in the base.

9. Closely examine the two mounting holes at the center of the wheelbase (underneath the base). You should see the holes of the main tube roughly aligned with the holes. Gently twist the main tube to make sure the holes are properly aligned (this will prevent the mounting bolts from binding and/or stripping later).
10. Take the pedal, and align the two mounting holes of the pedal base with the 2 holes in the center of the wheelbase. Make sure the foot pedal is between two of the wheel base spokes (and NOT under a spoke). If it is under a spoke, rotate the pedal 180° and align



Fig. 2-5

Correct placement of the pedal.

the holes again. Hold the pedal in place.

11. Using the 2 hex bolts with the blue thread-lock on the tips, bolt the foot pedal, wheel base and main tube together. Use the included hex key to tighten the bolts. Take care that the bolts go in straight and do not bind or strip (see Fig. 2-6).
12. Place the assembly back on its wheels.
13. Partially assemble the handle by fitting (snapping) the two insert sleeves into the two halves of the handle assembly.
14. Fix the handle to the top of the inner tube of the



Fig. 2-6

Example of a bolt that was not correctly inserted (pedal omitted for clarity).

main tube by screwing the two halves of the handle assembly around the tube using a #2 Phillips (star) screwdriver.

15. Take the computer base platform, and disassemble it by removing the two thumbscrews at the bottom, and separate the two halves. The half with the 3 holes will be mounted on the trolley along with the keyboard tray.
16. Take the keyboard tray and the bottom half of the computer base (the half with the three holes) and align them to the three holes on the top of the main

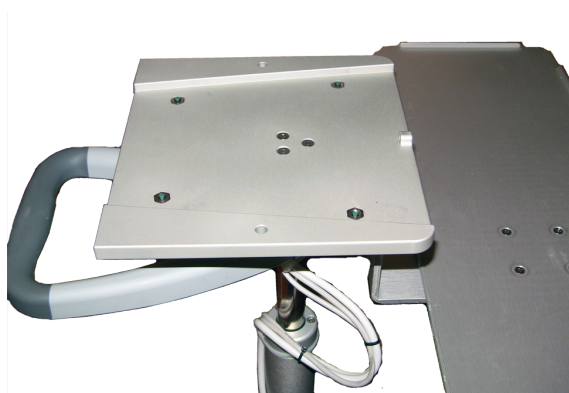

Fig. 2-7

Assembly of the computer base platform and the keyboard tray. The tray sits between the computer base platform

tube. Rotate the keyboard tray and/or the computer base to ensure that the keyboard tray is over the foot pedal and that the front of the computer base is over the foot pedal. The keyboard tray should be on the tube and the computer base should be on the keyboard tray.

17. Using the 3 counter-sink screws, secure the computer base and keyboard tray to the top of the main tube. Tighten the screws using your fingers first (and ensure they are not binding) and then tighten them using the included hex key. Make sure



and the top of the pole. The three screws go through the computer base and the keyboard tray and are fixed into the three holes in the pole.

the assembly is well secured and that there is no wiggle between the computer base and the tube.

18. Unpack the iMac computer and remove the plastic film covering the base.
19. Place the computer on the computer base, ensuring that the base fits into the cutout in the base platform. The base should not protrude past the height of the cutout.
20. Place the two foam spacers on the front part of the iMac base.
21. Place the upper part of the computer base on top of the lower part (sandwiching the iMac to secure it), and secure the upper part to the lower part using the two thumbscrews.
22. The power cable and 2 USB cables come as a harness (cables in a spiral wrapper). Plug the white power cable into the power outlet in the front of the I/O box (the part against the main tube of the trolley). Plug the two USB cables into plugs labelled USB 1 and USB 2. Run the cable up the tube, through the handle (the handle should be facing the rear of the trolley), through the hole of the iMac base into the iMac power receptacle in the rear.
23. Plug the power cable and the two USB cables into the receptacles at the rear of the computer. Note that it does not matter which USB ports are used, but using the ports towards the middle will minimize the clutter.

24. Press the foot pedal, and raise the iMac as high as it will go.
25. Tilt the iMac back to pull as much cable as will be required to tilt fully through the hole in the iMac base.
26. Take one long cable-tie to be used to fix the cable harness to the trolley handle in a way to take the weight of the cable off the connectors on the iMac: Observe where the harness comes close to the vertical pole of the trolley, between the trolley handle and the bottom of the iMac base.
27. Run the cable-tie through the spiral wrap of the power/usb cable harness and then around the pole at the location described above. Secure the cable-tie.
28. Plug the power cable into the rear panel of the I/O box, and into a power outlet.
29. Remove the twist-ties that secure the Vicra cable at the rear of the I/O box.
30. Follow the instructions in the Brainsight user manual to connect the Vicra to the Vicra cables (see, "Setting up a Vicra camera" on page 8).

Using the computer

1. Make sure that the mains switch at the rear of the trolley is set to ON.
2. Press the power button at the rear of the iMac. After a few seconds, you should notice it start up.
3. Once booted, follow the instructions in the Brain-

sight User Manual to operate the Brainsight system.

Software Updates

Like all modern computers, your Brainsight computer and software require regular software updates, which are supplied via the internet. Make the appropriate arrangements with your IT dept. to allow regular access to the internet by the computer.

SETTING UP THE POLARIS POSITION SENSOR

Your Brainsight system will have come with either a Polaris Vicra or Vega position sensor system.

If you are upgrading from a previous version of Brainsight with the traditional Polaris camera (with a serial number starting with P4-), and are using a Keyspan branded USB-Serial adapter, contact Rogue Research for an updated adapter and cable as the Keyspan adapters are no longer supported.

If you are using a Polaris Vega camera, please skip to the next section, "Setting up a Vega camera".

Setting up a Vicra camera

The Polaris Vicra position sensor system comprises the camera body, a cable with integrated USB-Serial adapter (dongle), a power supply and camera stand. If your Brainsight system included the mobile computer trolley, the power supply is stored in the trolley I/O Box and the interface cables will be attached to it.

The camera sits on top of a lighting stand with a flexible "gooseneck" segment between the two (Fig. 2-8). To



Fig. 2-8

Vicra position sensor camera on stand

The camera is connected to a flexible gooseneck segment using a camera mount adapter. The gooseneck is fixed to the top of the camera stand with a set screw.

assemble these:

1. Open the legs of the camera stand. As you open each of the three legs, they will snap into position at 120° increments of each other.
2. The flexible “gooseneck” bar has two ends, one for the camera mount adapter, and the other with a receptacle that fits on the top of the camera stand. Insert the camera stand end into the camera stand top, and tighten the set screw.
3. Fix the camera adapter to the other end of the gooseneck as in figure Fig. 2-9.
4. Fix the camera body to the camera adapter, again referring to Fig. 2-9.
5. The Vicra cable has a plug at one end (Lemo connector) that connects to the camera, and a dongle with power and USB jacks at the other end. String the Vicra connector through the hole in the camera mount adapter and then plug it into the Vicra taking care to align the red dots on the cable and camera connectors. Stringing it through the hole acts as a strain relief for the cable.
6. If you are using your own Brainsight computer (or an early model Brainsight trolley without the I/O box, refer to Fig. 2-10 for an illustration of the components to connect:
 - Connect the power supply cable into the power jack of the dongle.



Fig. 2-9

Close-up of Vicra on the camera stand.

The bottom of the gooseneck connects to the top of the stand, while the Vicra is connected to the gooseneck via the mounting adapter.

- Connect the USB cable into the dongle, and the other end into the Brainsight computer. Take care not to use a USB port on the keyboard as it may not provide enough power for the USB-Serial adapter causing the Vicra to function intermittently, or cause USB-over current error messages. If you are lacking ports, use a USB 2.0 (or higher) compliant powered hub.
- The Vicra power supply does not have a power



Fig. 2-10

Wiring diagram for Vicra (without Brainsight computer I/O box)

switch. When using the Vicra, simply plug the power into a powered surge protector.

7. If you are using the Brainsight trolley with an I/O box:
 - The power and USB cables should come out of the I/O box (are tied together). Connect the two into the power and USB jacks of the dongle.
 - The trolley will have a Vicra power button on the rear panel (see Fig. 2-2), so turn it on when you need to use the Vicra.

Setting up a Vega or Lyra camera

The NDI Vega and Lyra cameras combine power and Ethernet connections using a standard called Power over Ethernet (PoE). The power supply has two Ethernet connections, one for the Ethernet-in, and the other for Ethernet-out with power (added).

The Vega uses the same camera stand as the Vicra and Lyra however instead of the flexible gooseneck, it includes a ball mount that can support the weight of the Vega (Fig. 2-11).

1. Unscrew the thumbscrew on the side of the cylindrical mount protruding from the bottom of the ball mount adapter enough for it to fit on the top of the camera stand. Note the mating adapter can be fitted vertically or horizontally onto the camera pole. Fit the ball mount on the camera stand horizontally and tighten the thumbscrew to secure the ball mount to the pole. The horizontal orientation will



Fig. 2-11

Camera ball head adapter to hold the Vega camera

allow the Vega to point downwards more easily using the ball head.

2. The top platform of the ball mount (from which you removed the flat plate in the previous step should have a thumb lever that lock into place when the flat plate is replaced into position. Pull the lever out so the flat portion (with the screw that attaches the camera to it) of the top of the ball mount can be removed. The thumb lever should remain open to receive the plate again.
3. Attach the flat plate to the mounting hole of the rear of the Vega. Note the arrow indicating the “lens” direction of the mount that should face the bottom of the Vega.
4. Carefully attach the Vega to the ball mount by presenting the front edge of the plate into the receiver (see instructions that came with the ball mount for more details) and when it is inserted, tilt the camera to bring the plate flat into the receiver. When it is inserted correctly, the thumb lever should snap into place to lock the plate in the correct position. Verify that the camera is locked into place before letting go of the camera.
5. Connect the supplied Ethernet cable (that supports the PoE standard) to the Ethernet jack on the rear of the Vega. Connect the other end to the supplied power supply to the jack labelled Ethernet out (Fig. 2-12).

6. Connect an Ethernet cable from the Ethernet in of the power supply to your Ethernet router or directly to the Ethernet port of the Brainsight computer.
7. To turn on the Vega, plug the Power adapter to a suitable outlet. Note that there is no power switch.

Testing the Camera

The best way to verify proper functioning of the camera

is to try to track tools with it. Make sure the camera is turned on, and connected to the computer via the USB or Ethernet cable. Select **Windows->Polaris Configuration** to open the window (see Fig. 5-4). You should hear the Polaris reset beeps (2). Make sure the tools are enabled in the list, and move one of them in front of the camera while observing the checkbox next to the tool in the list.

If the check changes from a red "X" to a green "check", then it is tracking the tool. If instead of a red "X" or green check, you see a grey "X", then the tool is not enabled due to an error. Contact Rogue Research in this case.

TROUBLESHOOTING TRACKING PROBLEMS

The Polaris position sensor is a reliable and accurate device. When set up correctly, it will be able to track your tools without problems. If you encounter a situation where one or more tools do not seem to be tracking correctly, verify the following:

- That there is no glass (e.g. window, mirror) in the camera's field of view.
- That there are no sources of infrared light (e.g. halogen lamp) in the camera's field of view.
- That the spheres of the tool are free of scratches, dirt and are seated properly on the posts.
- That the lenses of the Polaris are clean. If needed, GENTLY wipe off dust and dirt using photographic lens cleaning solution and cloth (or lens paper).
- Make sure that you only have one tool of any given type (e.g. coil tracker) in the camera's field of view at a time.

Note that the camera requires periodic maintenance at the factory to maintain proper performance. The manufacturer suggests that the camera be re-calibrated annually, however we have found that the interval can be considerably longer (a few years). If you find that the

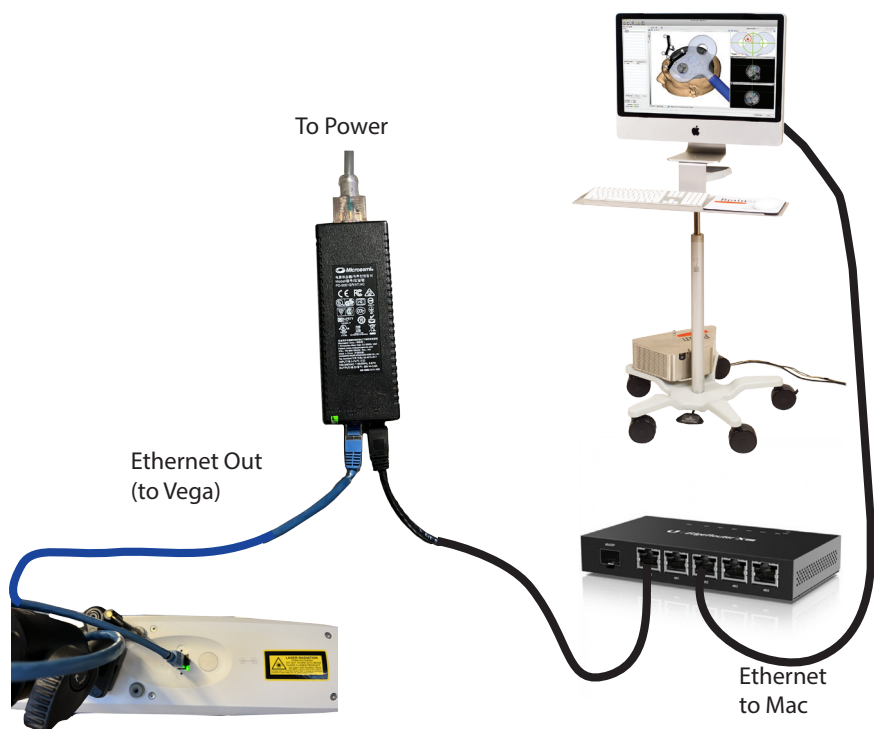

Fig. 2-12

Wiring setup for the Vega camera (when using a router)

camera's field of view is slowly shrinking, it is a sign that re-calibration is needed. Contact Rogue Research to arrange for re-calibration.

CLEANING THE TROLLEY AND COMPONENTS

The trolley and components are designed to function for its lifetime without maintenance other than cleaning. The trolley and components can be cleaned using a damp cloth and mild detergent. Ensure the ventilation holes on the computer and trolley I/O box are free of debris and that air can flow freely. The lenses of the Lyra or Vega as well as the computer monitor can be cleaned with plastic/glass surface cleaner.

Chapter 3: Gen 2 Trolley with Lyra or Vega

The Brainsight computer trolley is designed to provide a large screen computer, required input/output ports as well as an optional, integrated 2 channel EMG device in a small footprint, mobile platform. The version covered in this chapter was released in September 2023 when used with the Northern Digital Lyra or Vega camera with Power over Ethernet (PoE) connection. For instructions regarding the earlier computer trolley used with the Polaris Vicra, refer to Chapter 2. For instructions on assembly and use of the integrated EMG, please refer to “Chapter 4: EMG Pod”.



SCOPE:





This chapter should be used by whoever needs general instructions or specifications on the “Gen 2 Computer Trolley”. If used with the integrated EMG Pod, refer to Chapter 4 for safe and correct use of the EMG Pod. This manual includes all the necessary instructions to assemble and operate this equipment. No additional instructions or training is required.

ACRONYMS AND ABBREVIATIONS

EMG	Electromyography
PoE	Power over Ethernet
ME System	Medical-Electrical System
NIBS	Non Invasive Brain Stimulation
WAN	Wide Area Network

SAFETY SYMBOLS

	Advice. This symbol denotes advice to obtain the best results using the system.
	Attention! This symbol denotes information regarding the safe use of the equipment to prevent injury or damage to the equipment.
	Consult User Manual

	Do not trash. Dispose of this product according to the disposal instructions described in this manual.
	Type BF applied part.
	Do not tilt.
	Do not step on.

BASIC DESCRIPTION

The Gen 2 Computer trolley is a device that gathers several main components of the Brainsight navigator into a convenient mobile trolley. This allows flexible positioning of the computer and screen to ensure the operator can easily see and interact with the computer while operating the Brainsight system. In addition to the Mac computer (Mac Mini or Mac Studio) and monitor, it also contains the main components of the optional Brainsight MEP pod, electrical distribution connectors as well as an internal Ethernet router/switch to easily connect to Ethernet-based peripherals including the Polaris Lyra or

Vega camera.

OPERATING, TRANSPORT AND STORAGE ENVIRONMENT

Operating

- Temperature Range: min=15°C, max=30°C
- Humidity Range: 40%-60%
- Atmospheric pressure: 70-106kPA
- Use indoors
- Keep away from direct sunlight

Transport

- Temperature Range: min=-20°C, max=40°C
- Maximum humidity: 95%, non-condensing
- Handle with care



Storage





- Temperature Range: min=15°C, max=30°C
- Humidity Range: 40%-60%
- Store indoors
- Keep away from direct sunlight







Expected Product Lifetime

- 5 Years

WARNINGS AND CAUTIONS

	Use of this equipment adjacent to or stacked with other equipment should be avoided because it could result in improper operation. If such use is necessary, this equipment and the other equipment should be observed to verify that they are operating normally
	Use of accessories, transducers and cables other than those specified or provided by the manufacturer of this equipment could result in increased electromagnetic emissions or decreased electromagnetic immunity of this equipment and result in improper operation
	Portable RF communications equipment (including peripherals such as antenna cables and external antennas) should be used no closer than 30 cm (12 inches) to any part of the [ME EQUIPMENT or ME SYSTEM], including cables specified by the manufacturer. Otherwise, degradation of the performance of this equipment could result.

	The EMISSIONS characteristics of this equipment make it suitable for use in industrial areas and hospitals (CISPR 11 class A). If it is used in a residential environment (for which CISPR 11 class B is normally required) this equipment might not offer adequate protection to radio-frequency communication services. The user might need to take mitigation measures, such as relocating or re-orienting the equipment.
	Take care when handling cables to not pull on them against their connectors or pulling them around sharp edges or crushing them under furniture feet or wheels.
	Ensure that the trolley wheels are locked at all times unless the trolley is being moved.
	Ensure that the trolley is kept on a level surface with a tilt below 10 degrees.
	Do not attempt to service this device while in use.

	To avoid the risk of electric shock, this equipment must only be connected to a supply mains with protective earth.
	Do not modify this equipment without authorization of the manufacturer.
	If this equipment is modified, appropriate inspection and testing must be conducted to ensure continued safe use of the equipment.
	Do not replace any components that require tools to perform that are not explained in this manual. Other replacements should be performed by authorized personnel only.
	Only connect items to that have been specified as part of this ME system, or listed in this manual as compatible with this ME SYSTEM.
	The operator should not simultaneously touch any part of the system (e.g. computer, camera or conductive object) and the subject.
	Do not connect any multiple-socket outlet or extension cable to the ME SYSTEM.

SETTING UP THE TROLLEY

The mobile trolley (Fig. 3-1) consists of three main parts: the computer, the trolley itself, and the I/O box.

Main Components (unpacked)

The trolley consists several components (Fig. 3-1).

- Trolley base with wheels
- Trolley spine (with integrated cables)
- Spine extension (trolleys after Nov 2024)
- I/O box
- Isolation Transformer
- Computer tray
- Computer monitor
- Mac computer (mac mini or mac Studio)
- Accessory bin
- Cable and accessory box

Unpacking the System

The Brainsight NIBS Device is shipped packed in a cardboard crate. Inside the crate, the main components are packed in a combination of bubble and plastic wrap and cardboard boxes to protect them from damage during the shipping process.

1. Open the cardboard crate by removing the cardboard edge protectors on the top of the box and cutting or otherwise removing the packing tape securing the top flaps of the crate.

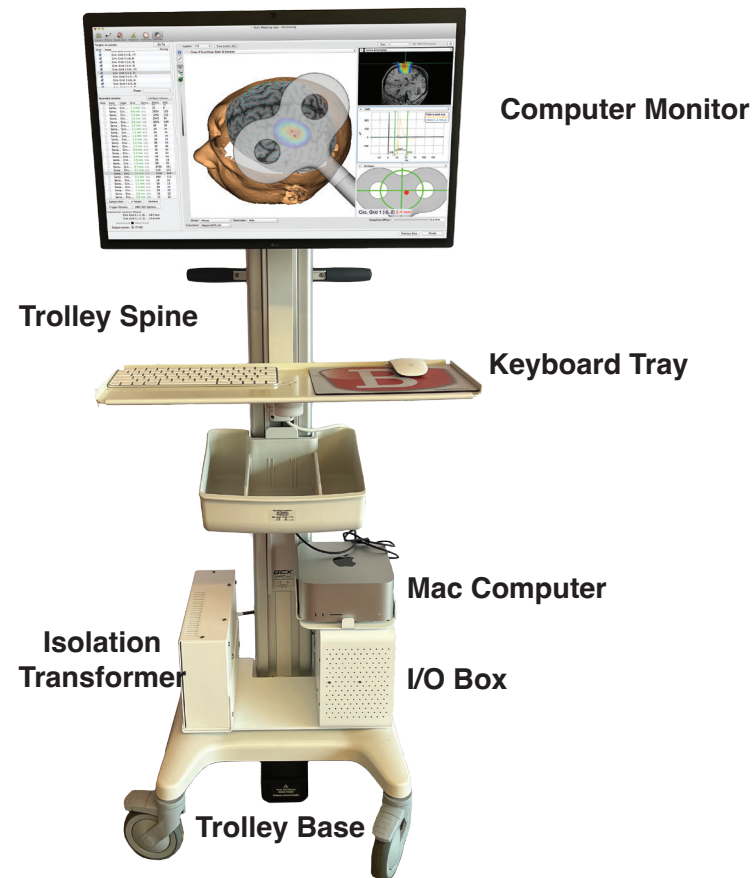

Fig. 3-1

Main Trolley Components

2. Remove the components inside the crate, taking note if any components are missing. If any component is missing, contact Rogue Research immediately.
3. Using the scissors or knife, remove the protective wrapping from all the components taking care not to scratch or otherwise damage any of them.

Assembling The Trolley

1. Lock the 4 wheels of the trolley base (by pushing down on the lock pedals of each wheel) to ensure it does not move unexpectedly during the assembly process.
2. Examine the under side of the trolley wheel base and note the 4 holes for the 4 spine retaining bolts (Fig. 3-2 A).
3. Place the base on the ground on the wheels.
4. Note that the spine has one end with 4 screw holes to secure it to the base (Fig. 3-2 B). Carefully place the spine onto the receptacle of the base.
5. With an assistant holding the spine in position, carefully insert the 4 retaining bolts into the holes and finger-tighten them to initially secure the spine to the base.
6. Tilt the base so that the spine is along the ground and the underneath of the base and the 4 mounting bolts are exposed and easily accessible.
7. Using the wrench provided, tighten the 4 bolts until the spine is tightly secured to the base taking care



A: Underneath of trolley base

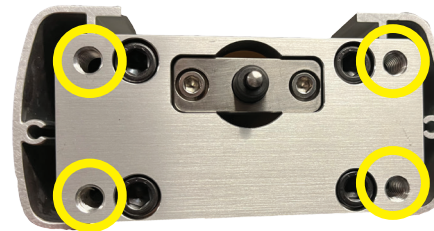

B: Bottom of trolley spine

Fig. 3-2

Bolt holes to attach the trolley spine to the trolley base. The holes are identified by the yellow circles.

to keep the wrench securely on the bolt (it may have tendency to slip).

8. Flip the base back onto the wheels and lock the wheels to prevent the base from rolling around.
9. If present, insert the spine extension (Fig. 3-3) into the vertical slot of the top of the spine. Using the hex key provided, tighten the 2 set screws to secure it to the spine.
10. Gently pull the cables already run through the length of the spine (monitor power and Thunderbolt) so they protrude beyond the top of the spine with enough extra to reach the monitor once installed (you will be able to adjust the lengths later).
11. Insert the monitor mount into the slot at the top of the extension taking care to ensure the cables run through the gap at the rear of the monitor mount (Fig. 3-3C). Secure the mount using the appropriate hex key to tighten the 2 set screws.

Installing the I/O Box and the Isolation Transformer

1. Examine the flat mounting plate on the top of the trolley base. Note one the left side (viewing from the rear) has 4 small pins to secure the I/O box (Fig. 3-4 A) and a vertical slot on the right side to secure the isolation transformer.
2. Examine the underside of the I/O box and note the 4 keyholes that will receive the 4 pins on the base (Fig. 3-4 B). Carefully place the I/O box on the base

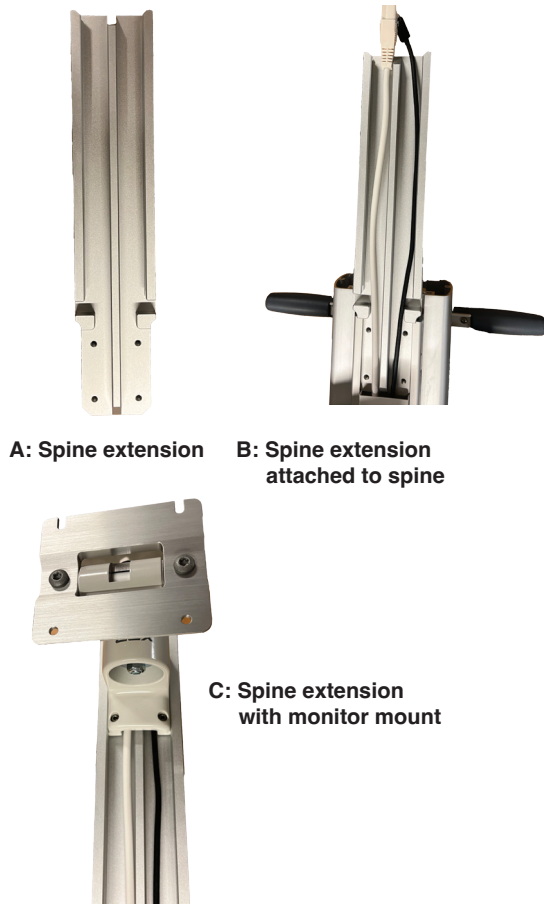

A: Spine extension **B: Spine extension attached to spine**

C: Spine extension with monitor mount

Fig. 3-3

Spine extension
(used with shorter trolley spine as of Nov 2024)



A: Receiver for the I/O Box on Trolley Base



B: Bottom of I/O Box

Fig. 3-4

A: I/O Box receptacle on Trolley Base and B: underneath of I/O box. Interface pins and keyhole receptacles are highlighted by yellow circles.

with the connector panel facing the rear of the cart so that the 4 pins insert into the 4 keyholes. Once seated correctly, push the I/O box forward so that the pins lock into the keyhole slots.

3. Use the securing clip to secure the I/O box by screwing the clip in place using the thumbscrew (Fig. 3-5)
4. Examine the horizontal plate on the other side of the trolley base. Note a screw hole on the front part of the plate and a vertical slot on the rear side.
5. Take the isolation transformer and flip it over to expose the underneath. Note the 2 screws along the right side of the underneath (looking from the connector side, see Fig. 3-6). Remove the forward right screw and keep it aside. Loosen the rear right screw without removing it completely.
6. Take the isolation transformer, turn it on its side and slide it into the receptacle of the base, taking care to ensure the right-rear screw (that you loosened in the previous step) inserts into the slot of the receptacle and that the cable connector panel is facing the rear of the trolley.
7. Using the screw removed and put aside, insert it into the receptacle hole in the front half of the retaining plate and screw it into the threaded receptacle of the isolation transformer.
8. Tighten the other screw that went into the slot

Installing the Computer

1. Take the computer tray and secure it to the I/O box using the 4 Phillips screws (Fig. 3-7 A).
2. Loosen the two thumbscrews under the computer tray and extend the sidebar to make room for the computer.
3. Unpack the computer and place it onto the tray with the connection panel (rear of the computer) facing the rear of the trolley.
4. Push the sidebar to apply pressure (grip) onto the side of the computer and tighten the thumbscrews to secure the computer (Fig. 3-7 B).

Install the monitor

1. Unpack the computer monitor.
2. Take the 4 M4 screws and partially insert 2 screws into the 2 upper receptacles of the monitor Vesa mount.
3. Take the monitor and slide it onto the receptacle at the top of the trolley spine such that the two upper screws slide into the 2 slots of the receptacle, loosely securing the monitor to the stand (Fig. 3-8).
4. Insert the two remaining M4 screws into the 2 lower holes and tighten them. Tighten the two upper screws to secure the monitor.
5. Connect the power cable emanating from the upper end of the trolley spine into the power receptacle at the rear of the monitor.



Fig. 3-5

I/O box Retaining Clip in place.

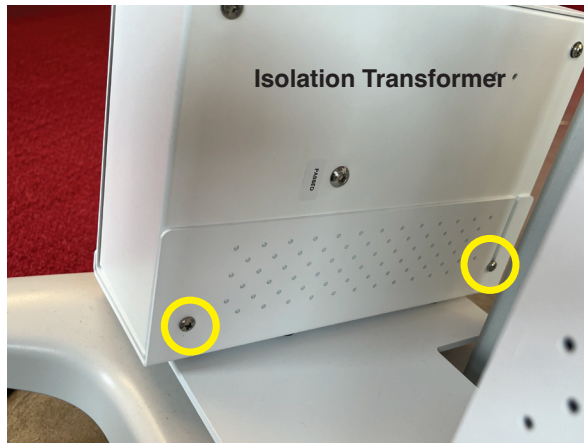

Fig. 3-6

Isolation Transformer secured in the Trolley Base receptacle. Screws to secure it are circled in yellow.

6. Connect the Thunderbolt cable into one of the thunderbolt connectors of the monitor.

Install the Keyboard Tray

1. Unwrap the computer keyboard/mouse tray arm and extend it from the trolley spine.
2. Unpack the computer keyboard/mouse tray and take the 3 screws and secure the tray to the arm (Fig. 3-9)
3. Unpack the compute keyboard, mouse and mouse pad, and place them on the keyboard tray

Connecting the cables

The connectors of the I/O box are identified in Fig. 3-10.

1. Take the short power cable and connect one to one of the receptacles of the isolation transformer and the other end into the main power input of the I/O box.
2. Take the computer power connector (from the accessory box) and connect one side to the computer and the other to one of the computer/monitor power receptacles of the I/O box (lower right).
3. Take the Monitor power cable emanating from the lower part of the trolley spine and connect it to the other computer/monitor power receptacle.
4. Connect the Thunderbolt cable emanating from the lower spine to one of the thunderbolt outlets on the computer.
5. Connect one end of the short Ethernet cable to the

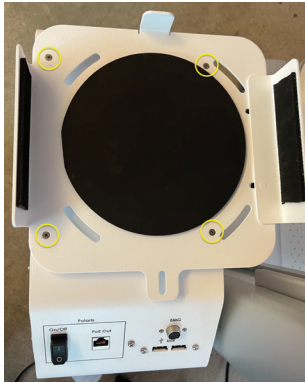

A: Computer Tray w. mounting screws



B: Computer Tray Side Bar w. thumbscrews

Fig. 3-7

A: Computer Tray mounted on I/O Box. B: Computer secured using the side-bar and thumbscrews (highlighted by yellow circles)



Fig. 3-8

A: Closeup of VESA adapter on the monitor installed on the stand.



Fig. 3-9

Keyboard Tray with mounting holes identified (yellow circle) and the keyboard, mouse and mouse pad in their typical location (for a right handed operator).

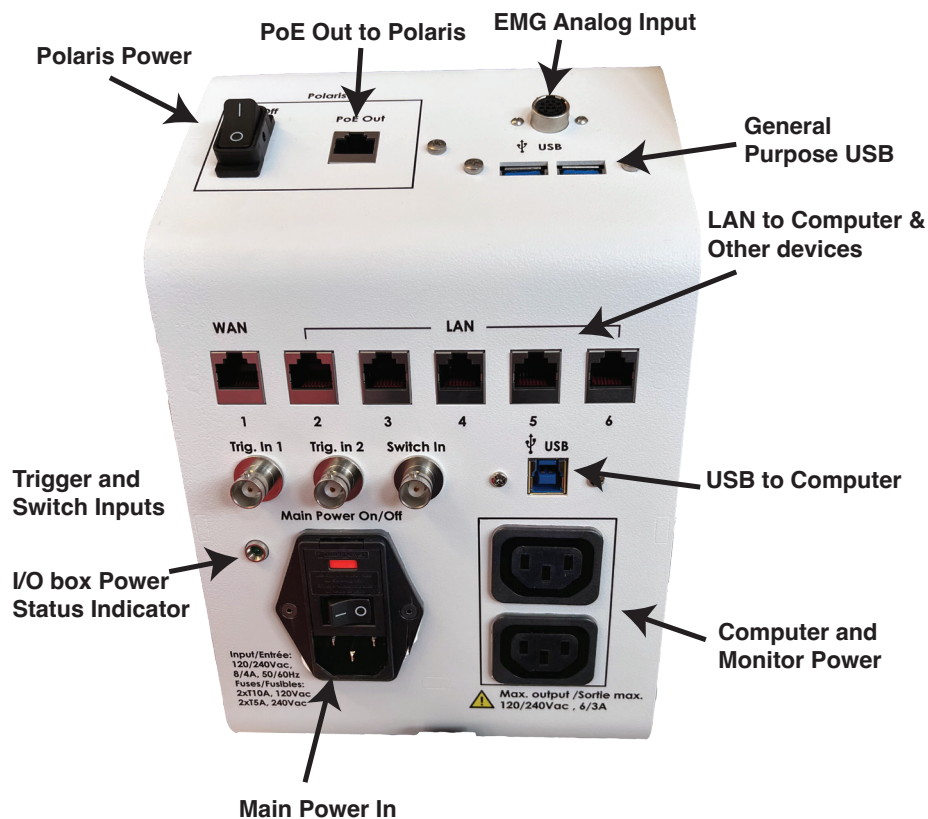

Fig. 3-10

I/O Box with the connections identified

Ethernet port of the computer and the other to One of the LAN Ethernet connectors (any of connection 2-6) ports.

6. Connect the USB cable to one USB port of the computer and the other to the USB port of the I/O box.
7. Connect the power cable to the mains supply and into the main power input of the Isolation Transformer.
8. Turn the main power switches of both the Isolation Transformer and the I/O box to on.

Connecting Peripherals (optional)

1. Unpack the footswitch and connect the BNC cable to the **Switch In** of the I/O box.
2. Connect the trigger out from your stimulator to one of the two **Trig. In** connectors.
3. Connect an active Ethernet cable (connected to a network with a DHCP server) to the **WAN** port.

Setting up your Lyra Camera

The camera sits on top of a lighting stand with a flexible “gooseneck” segment between the two (Fig. 3-11). To assemble these:

1. Open the legs of the camera stand. As you open each of the three legs, they will snap into position at 120° increments of each other.
2. The flexible “gooseneck” bar has two ends, one for the camera mount adapter, and the other with a



Fig. 3-11

Lyra camera on the camera stand.



Fig. 3-12

Closeup of the Lyra (rear view) showing camera mount and Ethernet cable connected.



Fig. 3-13

Closeup of the Vega camera attached to the ball-head on the camera stand.

receptacle that fits on the top of the camera stand. Insert the camera stand end into the camera stand top, and tighten the set screw.

3. Fix the camera adapter to the other end of the gooseneck as in figure Fig. 3-12.
4. Fix the camera body to the camera adapter, again referring to Fig. 3-12.
5. Connect the long Ethernet cable to the Lyra camera and using the Velcro straps, secure the cable to the camera stand taking care to allow enough looseness on the cable to allow free movement of the gooseneck.
6. Connect the other end of the Ethernet cable to the PoE out Polaris connector of the I/O Box.

Setting up your Vega Camera

The Vega uses the same camera stand however instead of the flexible gooseneck, it includes a ball mount that can support the weight of the Vega (Fig. 3-12).

1. Open the legs of the camera stand. As you open each of the three legs, they will snap into position at 120° increments of each other. Remove the plastic cap at the top end of the stand.
2. Unscrew the thumbscrew on the side of the cylindrical mount protruding from the bottom of the ball mount adapter enough for it to fit on the top of the camera stand. Note the mating adapter can be fitted vertically or horizontally onto the camera pole. Fit the ball mount on the camera stand horizontally

and tighten the thumbscrew to secure the ball mount to the pole. The horizontal orientation will allow the Vega to point downwards more easily using the ball head.

3. The top platform of the ball mount (from which you removed the flat plate in the previous step should have a thumb lever that lock into place when the flat plate is replaced into position. Pull the lever out so the flat portion (with the screw that attaches the camera to it) of the top of the ball mount can be removed. The thumb lever should remain open to receive the plate again.
4. Attach the flat plate to the mounting hole of the rear of the Vega. Note the arrow indicating the “lens” direction of the mount that should face the bottom of the Vega.
5. Carefully attach the Vega to the ball mount by presenting the front edge of the plate into the receiver (see instructions that came with the ball mount for more details) and when it is inserted, tilt the camera to bring the plate flat into the receiver. When it is inserted correctly, the thumb lever should snap into place to lock the plate in the correct position. Verify that the camera is locked into place before letting go of the camera.
6. Connect the supplied Ethernet cable (that supports the PoE standard) to the Ethernet jack on the rear of the Vega. Connect the other end to the supplied power supply to the jack labelled Ethernet out (Fig.

3-10).

7. Connect an Ethernet cable from the Ethernet in of the power supply to your Ethernet router or directly to the Ethernet port of the Brainsight computer.

OPERATING THE GEN-2 TROLLEY

1. If this is the first time the I/O box is being used, verify that the fuses on both the isolation transformer and on the I/O box are set to the appropriate voltage for your area. Use two T10A fuses for 120VAC or use two T5A fuses for 240VAC on the I/O box and for the isolation transformer follow the user guide provided by the manufacturer. If it is not already properly set, contact Rogue Research before connecting the I/O box to the computer, or the mains outlet.
2. Connect the medical grade isolation transformer to a wall outlet. To ensure reliable grounding plug the isolation transformer into an hospital grade wall outlet. Make sure the outlet is capable of providing 1000VA.
3. Turn on the main power switches on the Isolation Transformer and the I/O Box. The I/O box power status indicator light () should light up with a green colour. If it fails to turn on (green), verify that the power cable from the isolation transformer is well connected, the isolation transformer is correctly connected to an outlet and turned on. If the status indicator light fails to turn on, contact Rogue Research for further assistance.

4. Turn on the Polaris Camera by turning on the Polaris power button (Fig. 3-10).
5. Turn on the Computer by pressing the power button on the rear of the computer.
6. Adjust the height of the monitor and keyboard/ mouse tray by depressing the foot pedal at the front of the trolley, and moving the keyboard tray up/down as desired.

Testing the Camera

The best way to verify proper functioning of the camera is to try to track tools with it. Make sure the camera is turned on, and connected to the computer via the USB or Ethernet cable. Select **Windows->Polaris Configuration** to open the window (see Fig. 5-4). You should hear the Polaris reset beeps (2). Make sure the tools are enabled in the list, and move one of them in front of the camera while observing the checkbox next to the tool in the list. If the check changes from a red "X" to a green "check", then it is tracking the tool. If instead of a red "X" or green check, you see a grey "X", then the tool is not enabled due to an error. Contact Rogue Research if this is not resolved through troubleshooting (next section).

POWERING DOWN THE GEN-2 TROLLEY

When you are finished with the Brainsight system, you can power it down for later use, or movement to a storage location. To turn off the system:

- Make sure you have saved and closed your current

Brainsight project by selecting **File->Save**. If this is the first time you are saving this project, you will be prompted for a file name. Navigate the file browser to the appropriate directory, enter the file name and click Save.

- Quit Brainsight by selecting **Brainsight->Quit**.
- Quit any other applications you may be using following the instructions provided with each application.
- Shut the computer off by selecting **Apple->Shut Down...** . The computer may take several seconds to complete the shutdown sequence. The computer screen will go blank once the computer has completed its shutdown.
- It is safe to leave the I/O box and Polaris camera on indefinitely. If you plan on not using the system for an extended period, or expect to move the system, turn the Polaris camera off using the Polaris power button on the I/O box and turn the I/O box off by setting the I/O box main power switch to the off position.

TROUBLESHOOTING TRACKING PROBLEMS

The Polaris position sensor is a reliable and accurate device. When set up correctly, it will be able to track your tools without problems. If you encounter a situation where one or more tools do not seem to be tracking correctly, verify the following:

- That there is no glass (e.g. window, mirror) in the

camera's field of view.

- That there are no sources of infrared light (e.g. direct sunlight or halogen lamp) in the camera's field of view.
- That the spheres of the tool are free of scratches, dirt and are seated properly on the posts.
- That the lenses of the Polaris are clean. If needed, GENTLY wipe off dust and dirt using photographic lens cleaning solution and cloth (or lens paper).
- Make sure that you only have one tool of any given type (e.g. coil tracker) in the camera's field of view at a time.

Note that the camera requires periodic maintenance at the factory to maintain proper performance. The manufacturer suggests that the camera be re-calibrated annually, however we have found that the interval can be considerably longer (a few years). If you find that the camera's field of view is slowly shrinking, it is a sign that re-calibration is needed. Contact Rogue Research to arrange for re-calibration.

CLEANING THE TROLLEY AND COMPONENTS

The trolley and components are designed to function for its lifetime without maintenance other than cleaning. The trolley and components can be cleaned using a damp cloth and mild detergent. Ensure the ventilation holes on the computer and trolley I/O box are free of debris and that air can flow freely. The lenses of the Lyra or Vega

as well as the computer monitor can be cleaned with plastic/glass surface cleaner.

DEVICE COMPONENTS

Your Brainsight system can come in multiple configurations:

Brainsight System with trolley, Mac Mini, Lyra and EMG

- BSCT001: Brainsight computer trolley
- NTB003: IOBox, Rogue Research Inc.
- Mac Mini: A2686 or equiv., Apple Computer Inc.
- LG Monitor: 27MD5KLB-B: LG
- Polaris Lyra: 10009414, NDI Inc.
- Isolation Transformer: ISB-100W-UL, Toroid Inc.
- Foot Pedal: MED-100-5(E), XTronics Inc.

Brainsight System with trolley, Mac Studio, Lyra and EMG

- BSCT001: Brainsight computer trolley
- NTB003: IOBox, Rogue Research Inc.
- Mac Studio: A2615 or equiv., Apple Computer Inc.
- LG Monitor: 27MD5KLB-B: LG
- Polaris Lyra: 10009414, NDI Inc.
- Isolation Transformer: ISB-100W-UL, Toroid Inc.
- Foot Pedal: MED-100-5(E), XTronics Inc.

Brainsight System with trolley, Mac Mini, Vega and EMG

- BSCT001: Brainsight computer trolley
- NTB003: IOBox, Rogue Research Inc.
- Mac Mini: A2686 or equiv., Apple Computer Inc.
- LG Monitor: 27MD5KLB-B: LG
- Polaris Vega: 10009353, NDI Inc.
- Isolation Transformer: ISB-100W-UL, Toroid Inc.
- Foot Pedal: MED-100-5(E), XTronics Inc.

Brainsight System with trolley, Mac Studio, Vega and EMG

- BSCT001: Brainsight computer trolley
- NTB003: IOBox, Rogue Research Inc.
- Mac Studio: A2615 or equiv., Apple Computer Inc.
- LG Monitor: 27MD5KLB-B: LG
- Polaris Vega: 10009353, NDI Inc.
- Isolation Transformer: ISB-100W-UL, Toroid Inc.
- Foot Pedal: MED-100-5(E), XTronics Inc.

EMI/EMC TABLES

2.12.1 EMISSIONS compliance class and group

The Brainsight® NIBS system should be tested as a **class A group 1 ME SYSTEM**.

2.12.2 IMMUNITY TEST LEVELS

2.12.2.1 ENCLOSURE PORT

Phenomenon	Basic EMC standard or test method	IMMUNITY TEST LEVELS Professional healthcare facility environment
ELECTROSTATIC DISCHARGE	IEC 61000-4-2	± 8 kV contact ± 2 kV, ± 4kV, ± 8kV, ± 15kV air
Radiated RF EM fields	IEC 61000-4-3	3 V/m ⁸ 80 MHz – 2.7 GHz ⁹ 80% AM at 1kHz ¹⁰
Proximity fields from RF wireless communications equipment	IEC 61000-4-3	Refer to Table 10
RATED power frequency magnetic fields	IEC 61000-4-8	30 A/m 50Hz or 60Hz
Proximity magnetic fields	IEC 61000-4-39	See Table 11

Table 5: IMMUNITY TEST LEVELS for ENCLOSURE PORT¹¹

⁸ Refer to IEC 60601-1-2:2014+A1:2020 Table 4 for more details

⁹ Refer to IEC 60601-1-2:2014+A1:2020 Table 4 for more details

¹⁰ Refer to IEC 60601-1-2:2014+A1:2020 Table 4 for more details

¹¹ Source: IEC 60601-1-2:2014+A1:2020 Table 4

2.12.2.2 Input a.c. power PORT

Phenomenon	Basic EMC standard	IMMUNITY TEST LEVELS Professional healthcare facility environment
Electrical fast transients / bursts	IEC 61000-4-4	± 2 kV 100 kHz repetition frequency
Surges Line-to-line	IEC 61000-4-5	± 0.5 kV, ±1 kV
Surges Line-to-ground	IEC 61000-4-5	± 0.5 kV, ± 1 kV, ± 2kV
Conducted disturbances induced by RF fields	IEC 61000-4-6	3 V ¹² 0.15 MHz – 80 MHz 6 V ¹³ in ISM bands between 0.15 MHz and 80 MHz ¹⁴ 80 % AM at 1 kHz ¹⁵
Voltage dips	IEC 61000-4-11	0 % U_T ; 0.5 cycles ¹⁶ At 0°, 45°, 90°, 135°, 180°, 225°, 270° and 315° ¹⁷ 0 % U_T ; 1 cycle And 70 % U_T ; 25/30 cycles ¹⁸ Single phase: at 0°
Voltage interruptions	IEC 61000-4-11	0 % U_T ; 250/300 cycle ¹⁹

Table 6: IMMUNITY TEST LEVELS for Input a.c. power PORT²⁰

¹² Refer to IEC 60601-1-2:2014+A1:2020 Table 5 for more details
¹³ Refer to IEC 60601-1-2:2014+A1:2020 Table 5 for more details
¹⁴ Refer to IEC 60601-1-2:2014+A1:2020 Table 5 for more details
¹⁵ Refer to IEC 60601-1-2:2014+A1:2020 Table 5 for more details
¹⁶ Refer to IEC 60601-1-2:2014+A1:2020 Table 5 for more details
¹⁷ Refer to IEC 60601-1-2:2014+A1:2020 Table 5 for more details
¹⁸ Refer to IEC 60601-1-2:2014+A1:2020 Table 5 for more details
¹⁹ Refer to IEC 60601-1-2:2014+A1:2020 Table 5 for more details
²⁰ Source: IEC 60601-1-2:2014+A1:2020 Table 5

2.12.2.3 Input d.c. power PORT

Phenomenon	Basic EMC standard	IMMUNITY TEST LEVELS Professional healthcare facility environment
Electrical fast transients / bursts	IEC 61000-4-4	± 2 kV 100 kHz repetition frequency
Surges Line-to-line	IEC 61000-4-5	± 0.5 kV, ±1 kV
Surges Line-to-ground	IEC 61000-4-5	± 0.5 kV, ± 1 kV, ± 2kV
Conducted disturbances induced by RF fields	IEC 61000-4-6	3 V ²¹ 0.15 MHz – 80 MHz 6 V ²² in ISM bands between 0.15 MHz and 80 MHz ²³ 80 % AM at 1 kHz ²⁴
Electrical transient conduction long supply lines	ISO 7637-2	N/A

Table 7: IMMUNITY TEST LEVELS for Input d.c. power PORT²⁵

²¹ Refer to IEC 60601-1-2:2014+A1:2020 Table 6 for more details
²² Refer to IEC 60601-1-2:2014+A1:2020 Table 6 for more details
²³ Refer to IEC 60601-1-2:2014+A1:2020 Table 6 for more details
²⁴ Refer to IEC 60601-1-2:2014+A1:2020 Table 6 for more details
²⁵ Source: IEC 60601-1-2:2014+A1:2020 Table 6

2.12.2.4 Patient coupling PORT

Phenomenon	Basic EMC standard	IMMUNITY TEST LEVELS Professional healthcare facility environment
ELECTROSTATIC DISCHARGE	IEC 61000-4-2	± 8 kV contact ± 2 kV, ± 4kV, ± 8kV, ± 15kV air
Conducted disturbances induced by RF fields	IEC 61000-4-6	3 V ²⁶ 0.15 MHz – 80 MHz 6 V ²⁷ in ISM bands between 0.15 MHz and 80 MHz 80 % AM at 1 kHz

Table 8: IMMUNITY TEST LEVELS for Patient coupling PORT²⁸

2.12.2.5 SIP/SOP PORT

Phenomenon	Basic EMC standard	IMMUNITY TEST LEVELS Professional healthcare facility environment
ELECTROSTATIC DISCHARGE	IEC 61000-4-2	± 8 kV contact ± 2 kV, ± 4kV, ± 8kV, ± 15kV air
Electrical fast transients / bursts	IEC 61000-4-4	± 1 kV 100 kHz repetition frequency
Surges Line-to-line	IEC 61000-4-5	± 2 kV
Conducted disturbances induced by RF fields	IEC 61000-4-6	3 V ²⁹ 0.15 MHz – 80 MHz 6 V ³⁰ in ISM bands between 0.15 MHz and 80 MHz ³¹ 80 % AM at 1 kHz ³²

Table 9: IMMUNITY TEST LEVELS for Signal input/output PORT³³

²⁶ Refer to IEC 60601-1-2:2014+A1:2020 Table 7 for more details
²⁷ Refer to IEC 60601-1-2:2014+A1:2020 Table 7 for more details
²⁸ Source: IEC 60601-1-2:2014+A1:2020 Table 7
²⁹ Refer to IEC 60601-1-2:2014+A1:2020 Table 8 for more details
³⁰ Refer to IEC 60601-1-2:2014+A1:2020 Table 8 for more details
³¹ Refer to IEC 60601-1-2:2014+A1:2020 Table 8 for more details
³² Refer to IEC 60601-1-2:2014+A1:2020 Table 8 for more details
³³ Source: IEC 60601-1-2:2014+A1:2020 Table 8

Test frequency	Modulation	IMMUNITY TEST LEVEL (A/m)
30 kHz	N/A	N/A
134.2 kHz	Pulse modulation (50% duty cycle square wave) 2.1 kHz	65 (r.m.s. before modulation)
13.56 MHz	Pulse modulation (50% duty cycle square wave) 50 kHz	7.5 (r.m.s. before modulation)

Table 11: Test specifications for ENCLOSURE PORT IMMUNITY to proximity magnetic fields

Chapter 4: EMG Pod

The Brainsight 2 channel electromyography (EMG) acquisition device is designed to measure the voltages generated by muscle activity and provide that information to your Brainsight system. The voltages are measured on the skin using disposable, self-adhesive surface electrodes. Typically, it is used to measure the muscle evoked potential (MEP) generated by a TMS pulse, for example during motor mapping.

SAFETY NOTES



Statement of intended use



This device is intended for use in teaching and research applications only. This device is not intended nor should be used for medical applications. It is not intended to treat, diagnose or monitor a subject.

The EMG device comes pre-calibrated. No adjustment is needed throughout the life of the device.



Safety Symbols





The following symbols are used throughout this manual to highlight important safety information, or information that is especially important to obtain best results in using the apparatus.





	This symbol is used to denote advice to refer to the user manual for proper operating procedures and safety information.
	Attention! This symbol denotes information regarding the safe use of the equipment to prevent injury or damage to the equipment.
	This symbol is used to denote advice to obtain the best results using your Brainsight EMG system.

	Type BF Applied part. This means that the input connectors are suitable for connection to humans. There is no direct electrical connection to the earth.
	This symbol is used to denote a high voltage warning.

Safety Tips

	Keep the subject out of reach from the computer or any other non-isolated device or other person touching non-isolated parts. The subject should only be able to reach and touch all BF applied parts including electrode leads, the differential sensor and isolation unit.
	Use disposable surface electrodes. Do not use implanted electrodes. Do not use electrodes beyond their expiration date as shown on the package.
	Make sure the cables are well managed to prevent the subject or others around the subject from tripping on them.

	Make sure that the position of the computer trolley enables easy access to the main power cord in case immediate disconnection is required.
	To avoid temporary discomfort when applying the electrodes, snap the disposable electrodes to the electrode leads prior to applying the electrodes to the skin. Otherwise, the pressure required to snap the leads to the electrodes while on the skin may cause minor, transient discomfort.
	If the equipment fails to perform as expected, immediately discontinue use and contact Rogue Research for customer support or repair/replacement of the unit.
	If using the I/O box, a medical grade isolation transformer has to be used. Make sure fuse rating of both parts are correctly set to your local voltage. Failure to do so may result in damage to your equipment, or loss of protection.
	This device may cause electrical disturbances in sensitive equipment within its operating environment

	Connection of a PATIENT to high frequency (HF) surgical equipment and to an ELECTROMYOGRAPH or EVOKED RESPONSE EQUIPMENT simultaneously may result in burns at the site of the ELECTRODES and possible damage to the APPLIED PARTS
	Do not modify the equipment in any way. Modifying the equipment in any way may lead to data quality degradation, introduce potential safety hazards and void conformity to safety standards.
	Operation in close proximity to a short-wave or microwave therapy equipment may produce instability in the APPLIED PARTS.
	Ensure that all components are kept away from sources of electromagnetic radiation. Failure to do so may result in data with additional noise.
	Avoid accidental contact between connected but unapplied APPLIED PARTS and other conductive parts including those connected to protective earth.

	Examine the paths of all the wires, particularly the ones from the amplifier to the isolation box, and from the isolation box to the analog receiver. Try to avoid loops in the wire as they may pick up noise. Keep the wires away from the TMS coil and cable. To minimise noise from the input, short electrodes leads can be twisted. This will reduce the loop area and it's likely to induce less noise on the inputs.
	The computer is plugged into the electrical mains. Use caution when connecting or disconnecting the computer power cable.
	Do not attempt to service this device while in use.
	To avoid the risk of electric shock, this equipment must only be connected to a supply mains with protective earth.
	Do not modify this equipment without authorization of the manufacturer.

	If this equipment is modified, appropriate inspection and testing must be conducted to ensure continued safe use of the equipment.
	Do not replace any components that require tools to perform that are not explained in this manual. Other replacements should be performed by authorized personnel only.
	Only connect items to that have been specified as part of this ME system, or listed in this manual as compatible with this ME system.
	The operator should not simultaneously touch any part of the system (e.g. computer, camera or conductive object) and the subject.
	Do not connect any multiple-socket outlet or extension cable to the ME system.

Fig. 4-1

Device overview: Parts used near the subject.

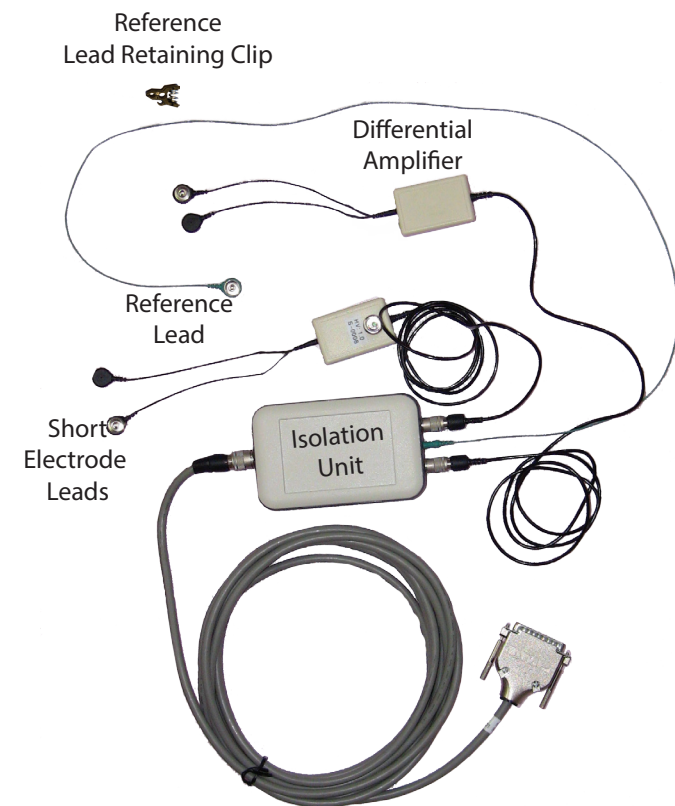

Contraindications

- Do not use on patients with implanted electronic devices of any kind, including pacemakers, implanted defibrillators, electronic infusion pumps, implanted stimulators or any similar electronic assistive devices.
- Do not use on irritated skin or open wounds.

OPERATING, TRANSPORT AND STORAGE ENVIRONMENT

Operating

- Temperature Range: min=15°C, max=30°C
- Humidity Range: 40%-60%
- Use indoors
- Keep away from direct sunlight

Transport

- Temperature Range: min=-20°C, max=40°C
- Maximum humidity: 95%, non-condensing
- Handle with care

Storage

- Temperature Range: min=15°C, max=30°C
- Humidity Range: 40%-60%
- Store indoors
- Keep away from direct sunlight

Expected Product Lifetime

- 5 Years

MAIN COMPONENTS:

The EMG device consists of several components. Some of which are to be used near the subject and are electrically isolated while some are near and connected to the computer. The two are linked by an analog cable.

Differential amplifier.

The differential amplifier has a shielded 3-pin mini connector to accept a twin electrode lead. A cable connects the amplifier to the isolation unit via a push/pull-style connector. It performs an analog subtraction of the signal from one surface electrode from the other. The amplifier is small enough to be worn near the measurement site (e.g. wear it on the wrist to measure finger muscles). A snap connector is fixed to the case to allow you to snap it to a velcro strap (e.g. to be worn on the wrist).

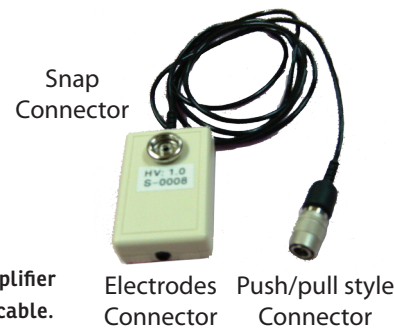

Fig. 4-2

Differential amplifier and connector cable.

Electrodes Connector Push/pull style Connector



Short electrode leads

The electrode lead is specially designed to minimise signal contamination from external electrical sources (e.g. 50-60 Hz mains). It is shielded and uses a single mini 3-lead plug for the two electrode signals and the shield ground. The electrode connector is a standard snap style to ensure compatibility with a variety of surface electrodes (e.g. MEDI-TRACE™ Mini 130 Pediatric Foam Electrodes or equivalent).



Fig. 4-3

Twin-electrode lead.



Reference electrode lead

The reference electrode lead is connected directly to the isolation box using a 1.5mm mini-din connector. The reference electrode is connected to the lead by a snap connector. You can use the same surface electrode as with the other electrodes, however a larger reference electrode is preferred when available. You can also use disposable reference electrodes (e.g. Ambu® Neuroline Ground electrodes).



Fig. 4-4

Reference electrode lead.



Isolation unit.

The isolation box can accommodate the signals from two differential amplifier pods.

The front of the box has two push/pull style connectors, one for each amplifier pod and a 1.5mm mini-din receptacle for the reference lead. The rear of the box (Fig. 4-5, right) has a larger push/pull connector for one end of the analog cable which links to the analog receiver.

The connectors leading to the amplifier and the reference lead are Type BF applied parts.



Fig. 4-5

Isolation unit: Left: viewed from the front. Right: Viewed from the rear.



Fig. 4-6

Both models of Analog Receiver Cables. Left: Push-pull connector to DB25 for Gen-1 I/O Box and standalone Analog Receiver. Right: Push-pull to Push-pull cable for Gen-2 I/O Box.



Analog Receiver

The Analog receiver can either be a stand-alone box, or incorporated into one of two models of Brainsight computer trolley "I/O Box". Refer to the respective chapters of this manual for assembly and use of the computer trolley.

The standalone receiver includes the receiver and a medical grade power supply. The front of the standalone box has a DB-25 connector (labelled "analog Input") to connect to the isolation box, a USB connector to connect to the Brainsight computer and a power input jack for



To maintain compliance with IEC 60601-1 regarding the earth leakage current, the computer connected via the USB cable must conform to IEC 60601-1 standard for medical device safety. If the computer does not conform to this standard, the computer and/or the I/O Box mains must be connected to a medical grade isolation transformer (e.g. ISB-100W from Toroid Corporation of MD). In any case, the subject must always be kept out of reach of the computer and any peripheral connected to it in order to prevent touch current.

the medical grade power supply. The rear of the box has three BNC connectors, two for TTL triggers (from up to two TMS devices) and one for a switch.

CLEANING THE EMG DEVICE

If you need to clean peripherals likely to be in contact with different subjects, they can be cold-sterilised with an

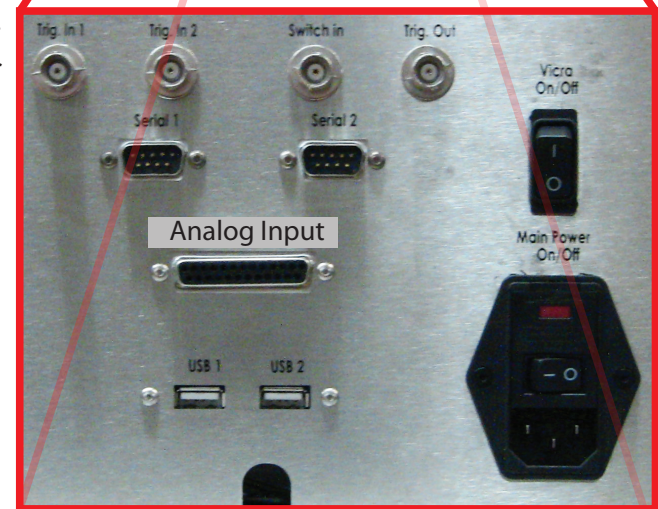

Fig. 4-7

Standalone Analog Receiver with power supply: Left: Front of unit with analog input connector, USB connector and the DC input connector. Lower left: Medical grade power supply. Below: Rear of receiver with trigger inputs. Right: I/O Box as Brainsight computer trolley.



appropriate sterilizing agent. No part of the system can be placed in an autoclave. Shut down and disconnect all cables before cleaning. Use a damp, soft, lint-free cloth and mild detergent, with isopropyl alcohol swabs, or with a 70% isopropyl alcohol solution to clean the exterior of the enclosures. Avoid getting moisture in any openings. Do not spray liquid directly the enclosures. Do not use aerosol sprays, solvents, or abrasives.

The elastic/Velcro straps holding the amplifier to the subject may be cleaned by unsnapping it from the amplifier and soaking it in a mild detergent, rinsed and hung to dry.

INSPECTING THE EMG DEVICE

All components should be visually inspected before each use to ensure that no mechanical deterioration has occurred. It is important to periodically visually examine the covering of the cables for cuts and tears as well as checking the connectors for bent pins, exposed wires or any other damage.

PREPARING THE EMG DEVICE FOR USE

Before using the device, make sure that you have enough unused surface electrodes (two per channel) and a reference electrode. Review Fig. 4-1 for a complete wiring diagram.

If you have the standalone analog receiver:

Connect the analog receiver to the Brainsight computer:

1. Plug the medical grade power supply to a main

power outlet.

2. Using the included USB cable, connect the USB port on the analog receiver to a USB port on the computer.
3. Connect the medical grade power supply to the DC input on the front panel of the analog receiver to activate the receiver. To deactivate the receiver, either unplug the DC input at the receiver, or unplug the medical grade power supply from the main outlet.
4. Using a cable with BNC connectors, connect the output trigger of the TMS device to one of the trigger-in ports of the analog receiver.

If you have the Gen-1 or Gen-2 I/O box:

Follow the assembly and use instruction of this user manual for safe and correct operation of the computer trolley. power cable connected to the main switch.

Connecting the EMG Parts to the Analog Receiver or I/O Box

1. Connect one or both amplifiers to the isolation box by plugging in the connector(s) into the receptacle(s) labelled "CH 1" or "CH 2" on the isolation box by holding the connector by the black plastic portion, gently pushing the connector into the receptacle while rotating the connector until it clicks into the receptacle (i.e. they are correctly aligned).



If only one channel is used, unplug the unused channel to prevent accidental contact with non-isolated device or undesirable voltage source.

2. Connect the analog cable to the isolation box by plugging the appropriate connector into the receptacle of the isolation box labelled "To Analog Receiver" using the same method as with the amplifier connector above.
3. If you are using a standalone Analog Receiver or Gen-1 I/O box, connect the other end of the analog cable (DB-25 connector) to the connector labeled "Analog Input" by pushing it into the connector labelled and secure it by tightening the two thumbscrews on either side of the connector. If you are using a Gen-2 I/O box, connect the push-pull connector of the cable into the connector labelled "EMG".

USING THE EMG DEVICE.

1. Make sure the subject is kept far enough away from the computer to prevent touching it.
2. Decide on your measurement location. Typically one electrode goes on a muscle and the other on a bony location near the first electrode. Fig. 4-8 shows a typical electrode configuration.
3. Place the isolation box near the subject. The box comes with a belt clip to allow the subject to wear it on the waist.
4. Using the Velcro strap, attach the differential amplifier to the subject close enough such that the short leads can reach the electrodes. The Velcro strap has a snap on it that snaps into a receptacle on the

- amplifier. For a finger twitch (using TMS) exercise, placing the strap around the wrist is a good choice.
5. Connect the snap end of the short electrode leads to the surface electrodes, and the shielded mini-din into the amplifier pod. **Note that disposable electrodes should only be used once. A “flat line” may result if the electrodes are reused or have expired.**
 6. Prepare the skin surface according to the instructions that came with the surface electrodes.
 7. Apply the electrodes to the skin following the instructions that came with the electrodes.
 8. Repeat steps 4-7 for the second channel if you are planning to use it.
 9. Attach the reference lead to the subject, usually on a bony surface or other reasonable neutral location (e.g. away from muscle).
 10. Connect the other end of the reference lead into the reference connector on the isolation box.
 11. Follow the instructions included with your Brainsight system to configure the software to record the data from the EMG unit and perform your experiment according to your protocol.

SAFELY TERMINATING USE OF THE EMG DEVICE

The Brainsight EMG device was designed to operate in a safe and reliable manner. If for any reason, the use of the device needs to be terminated quickly and safely, simply do ANY of the following:

- Remove the electrodes (both the signal electrodes and the reference electrode) from the subject. The electrodes are self adhesive and are easily removed. They can be removed at any time.
- Disconnect the differential amplifier and reference lead. You can either disconnect the electrode cable from the amplifier by pulling out the connector, or the amplifier from isolation unit by pulling out the connector. Disconnect the reference lead cable from the isolation unit by pulling the connector out of the receptacle.
- Disconnect the isolation unit from the Brainsight computer. You can disconnect it by pulling the cable connector out of the receptacle of the isolation box.

ERROR MESSAGES

Error messages related to the EMG device are displayed in the trigger options window (Fig. 16-15). The following is a list of error messages and remedies:

No trigger box hardware can be found

See the Troubleshooting section for instructions on verifying that the hardware is connected properly.

TROUBLESHOOTING

Your EMG unit was designed to be easy to use and to provide accurate results. Nevertheless, some problems may occur.

The EMG (or anything else) is not sampled when



Fig. 4-8

Example of electrode placement (the electrode on the index finger would actually be better if it were on the knuckle).

the coil is triggered.

This can occur if the subject and coil tracker are not visible by the Polaris camera, the trigger pulse from the TMS device is either not reaching the trigger-in, or if the trigger signal is not compatible with the I/O box. First, make sure the trigger cable is correctly plugged in (and that the cable is not damaged). Next, verify that Brainsight is correctly configured to trigger an event recording using the correct trigger in. Finally, the trigger pulse itself must be a rising pulse (0-5V) and must last longer than 5ms.

The EMG is being triggered, but the resulting waveform is flat, random noise.

Check that the surface electrodes and reference electrode are properly fixed to the subject's skin, and in the case



Examine the paths of all the wires, particularly the ones from the amplifier to the isolation box, and from the isolation box to the analog receiver. Try to avoid loops in the wire as they may pick up noise. Keep the wires away from the TMS coil. To minimise noise from the input, short electrode leads can be twisted. This will reduce the loop area and it's likely to induce less noise on the inputs.

of disposable electrodes, that they are fresh. Make sure that the electrode leads are correctly plugged into the amplifier and that the reference lead is correctly plugged into the isolation box. Check that the amplifier(s) are plugged into the isolation box and that the isolation box is connected to the analog receiver. Make sure you are stimulating an area that should elicit an MEP response in the muscle being monitored. Check that you have configured Brainsight to sample the same amplifier (e.g. channel 1 or 2) that you are using.

The EMG is being triggered and we see a waveform, but we are also getting a lot of noise.

Make sure that the electrodes are well secured on the skin, and that the skin was prepared before fixing the electrodes (e.g. rubbed with an alcohol wipe, etc.). Make sure the locations of the electrodes are correct. Make sure that the reference lead is well placed and properly

fixed to the skin. Make sure that the cables are not near the TMS coil when in use. Keep the cables away from large sources of electromagnetic radiation and prevent loops in the cables.

Further Assistance

If your problem was not solved with the above information, you can contact us directly by e-mailing us at support@rogue-research.com. We can also be reached at +1 514 284-3888 (or toll free in North America at 1-866-984-3888).

ELECTROMAGNETIC COMPATIBILITY

Medical electrical equipment requires special precautions regarding EMC and needs to be installed and put into service according to the EMC information provided in this manual.

Portable and mobile RF communications equipment can affect Medical Electrical Equipment.

The EMG unit should not be used adjacent to or stacked with other equipment and that if adjacent or stacked use is necessary, the EMG unit should be observed to verify normal operation in the configuration in which it will be used.

The use of Accessories, transducers, and cables other than those specified by the manufacturer, may result in increased Emissions or decreased Immunity of the EMG unit.

EMG SYSTEM SPECIFICATIONS

Overall System:

- Overall EMG Amplification:
Models 1 & 2 amplifiers 13500 V/V:
Model 3 amplifiers 4444 V/V:
- Input range: **Models 1 & 2:** 1.5mVpp,
Model 3, 4.5 mVpp
- Overall Bandwidth: 16-470 Hz
- Overall Noise: **Models 1 & 2:** <5.33 μ Vpp (R.T.I),
Model 3: <10 μ Vpp (R.T.I)
- ADC resolution: 12 bit
- ADC sampling rate: 3kHz per channel
- Power Consumption: 9Vdc, 1.5 A and USB 5Vdc, 500mA
- BF Applied part Isolation Voltage: 5300 VRMS

Sensors:

- Bandwidth: 16-550 Hz
- CMRR (60Hz): -115 dB (typical)
- Input Impedance: 300 (minimum), 1250 (Typical) Ω //1.6pF

ANALOG CABLE PINOUTS

Note that only Channels 1 & 2 are used.

PARTS LIST

With I/O box (vers model NTB003)

- 2x Differential amplifier SENS003: Rogue Research Inc.
- 1x Isolation unit BELT002: Rogue Research Inc.
- 1x BNC Coaxial Cable 10FT long for trigger port: 115101-19-120: Amphenol RF
- 1x BNC "T" Adapter: 112461: Amphenol RF
- 1x Analog Cable ANAH001: Rogue Research Inc.
- 1x Reference electrode Lead Green 1.5mm DIN 441273X25036001
- 2x Short electrode Leads ELECO01: Rogue Research Inc.
- Clip, Lapel: 38031: PI Technologies
- ECG Electrode: 31112496: Cardinal Health
- Neuroline Ground: 71410-M-1: Ambu Inc.

With I/O box (vers model NTB002)

- 2x Differential amplifier SENS003: Rogue Research Inc.
- 1x Isolation unit BELT002: Rogue Research Inc.
- 1x BNC Coaxial Cable 10FT long for trigger port: 115101-19-120: Amphenol RF
- 1x BNC "T" Adapter: 112461: Amphenol RF

- 1x Analog Cable ANAC001: Rogue Research Inc.
- 1x Reference electrode Lead Green 1.5mm DIN 441273X25036001
- 2x Short electrode Leads ELECO01: Rogue Research Inc.
- Clip, Lapel: 38031: PI Technologies
- ECG Electrode: 31112496: Cardinal Health
- Neuroline Ground: 71410-M-1: Ambu Inc.

Pin	Description	Pin	Description
1	5V USB bus	14	0V USB bus
2	Ch1+	15	0V USB bus
3	Ch1-	16	Ch2+
4	0V USB bus	17	Ch2-
5	Ch3+	18	0V USB bus
6	Ch3-	19	Ch4+
7	0V USB bus	20	Ch4-
8	5V USB bus	21	NC
9	NC	22	NC
10	NC	23	NC
11	NC	24	NC
12	NC	25	0V Medical Supply
13	9V Medical Supply		

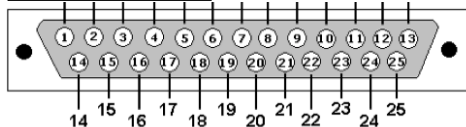

Fig. 4-9

Cable pinout diagrams for the 2 models of Analog receiver cable. Left: ANAC001001. Right: ANAC002001.

DISPOSAL

Dispose of the product in accordance with your local government requirements. Contact your local recycling centre for more information. For more information about product content contact Rogue Research Inc.

Description	Pin
5V USB	1
Ch1-	2
Ch1+	3
5v USB	4
Ch2+	5
Ch2-	6
5v USB	7
0V Medical Supply	8
9V Medical Supply	9
0V USB	10
0V USB	11
0V USB	12

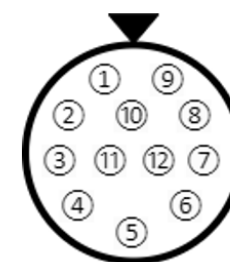

Front view

Chapter 5: Installing Brainsight

Brainsight uses a simple installer to install the software and various components with the exception of your tool files, which need only be installed once. If you are a Brainsight 1 user, the file format for your tools has changed. You will need a new serial number to download Brainsight 2 and the new tool files. Contact Rogue Research for more details.

COMPUTER SETUP

If you are providing your own computer, it is recommended to create a (or more) password protected account to ensure any data that may contain sensitive information is secure.

GET THE SOFTWARE

If you have an up to date Brainsight CD or USB thumb-drive, insert it into the computer's CD drive or USB port. Otherwise, follow the instructions on the downloads page at www.rogue-research.com to download the disk image and if you have not done so yet, your tools archive and support files.

Fig. 5-1

Example of a Brainsight disk image.

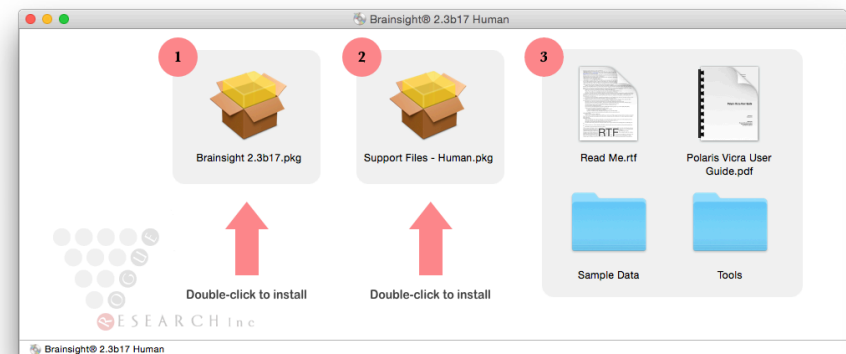

INSTALLING THE SOFTWARE

Brainsight uses an installer to install the software as well as the drivers and support files. Double-click on the disk image to mount it on your desktop.

Double-click on the installer package to initiate the install process (Fig. 5-1).

Fig. 5-2

First step in the installer.



Fig. 5-3

Final confirmation screen.

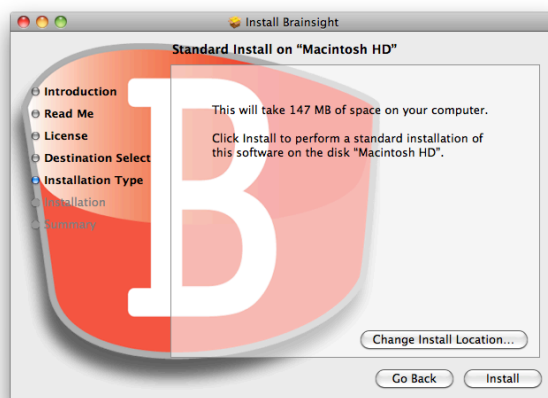

Click on Continue to get to the terms of use page. If you agree to the terms, then click "Continue" a second time. In the next screen (Fig. 5-3), simply click "Install" and all the required components will be installed.

Once you click the Install button, you will be requested to enter the name and password of a user with administrative privileges. Enter it to continue the install.

Note that as of macOS, the USB->serial driver needed to communicate with the Polaris P4, Vicra and Spectra was built into the OS itself, so we no longer need to install a separate driver for this. We strongly recommend you update your macOS as this is a more robust solution by eliminating the need for an external driver and the

associated security permissions issues it has caused over the years.

Once the install is complete, the final screen will appear confirming success. Click on the Close button to complete the install.

INSTALLING SUPPORT FILES

(Perform this only once)

If you have not already done so, install the TMS support files. These include sample data (which will be installed on your desktop) as well as the files needed for MNI atlas support and the model head-based project template.

Double-click on the **Support Files-Human.mpkg** icon to launch the installer. Follow the same steps described in "Installing the Software" on page 40 to complete the installation.

QUICKLOOK PLUGIN

One of the software components installed is a Quicklook™ plugin. This adds the ability to display preview thumbnail images rather than a generic icon. The plugin supports many of the image data formats supported by Brainsight including (but not limited to) DICOM, MINC, NIFTI and Analyze. Note that if you use other software on your computer that installs its own QuickLook plugin for the same formats, either one may be called upon by the operating system.

INSTALLING YOUR TOOLS

(Perform this only once)

Brainsight uses a simple file to represent each of your tools and are included with your Brainsight CD or USB key, as well as stored in a database keyed to your Brainsight serial number that can be accessed via our web site. Note that if you have already installed your new tools for an earlier version of Brainsight 2.x (including any beta versions), you can skip this step, otherwise:

Make sure your tools folder is accessible (i.e. decompress it if it is an archived folder by double-clicking on the archive).

1. Launch Brainsight, and click **I Agree** to dismiss the splash screen.
2. Select **Window->Polaris Configuration** to open the Polaris window (Fig. 5-4).
3. Click **Add...** and select all the tools in the subsequent file selection dialog box. Click Open to confirm the selected tools. Note that the tools should appear in the list of tools.
4. If they are not already enabled, Enable each tool by clicking on the check box next to each one. Note that you can only enable one tracker of a type (e.g. CT-xxx class of trackers) at any given time. If, for example, you wish to calibrate two separate coils, both with CT-type trackers, then you will have to enable one first, perform the calibration, then return to this screen again to switch the enabled tracker to the other, then calibrate that second coil. When you are using the coils during a TMS session, Brainsight will

automatically switch the active tracker if you switch the tracked tool.

Once all the tools have been added, you can delete the tools folder you downloaded since Brainsight has copied the tools into the private folder.

Newer models of the Polaris camera (e.g. Vega, Lyra) have changed from a serial/USB cable to Ethernet. This opens the possibility of having more than one camera visible on the Ethernet network. If you have more than one camera, select your camera from the popup button. This selection will be used throughout the software

Note:

If you are upgrading from Brainsight 1.5 or earlier and are using a P4 model Polaris (serial number P4-xxxxx), you may need to run the Polaris firmware updater, or the camera will fail to track your tools. Note the P4 line of cameras has been discontinued by the manufacturer, NDI and maintenance is no longer available. Contact Rogue Research for assistance in updating your camera or in discussing upgrade options.

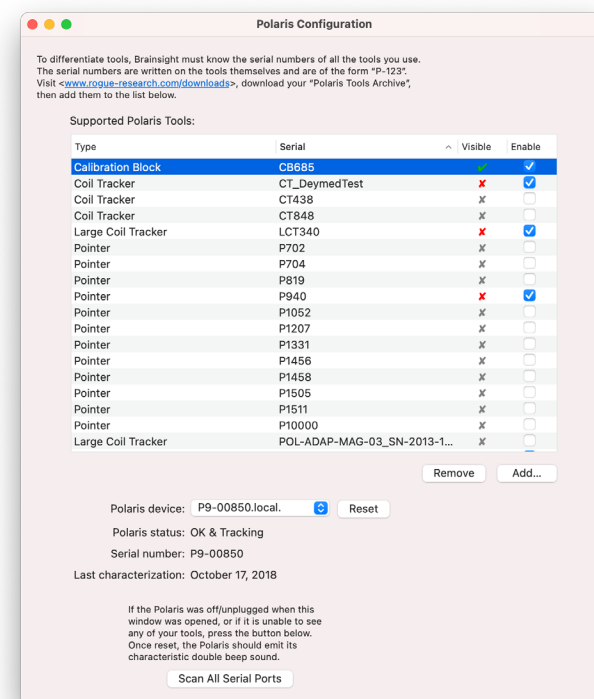

Fig. 5-4

Polaris Configuration Window

where interaction with the Polaris camera is required. You may need to come back to this screen after you have assembled and turned on your Vega

SETTING YOUR PREFERENCES

When you first install Brainsight, it should work “right out of the box”. There are many options that allow you to customize certain aspects of the software. This section will describe these options. Some of these options require an understanding of the software’s functionality that is described later in the manual. It is a good idea to read through this as a list first with the understanding that many of these options will become clearer once you have familiarized yourself with the different aspects of Brainsight.

Launch Brainsight, and select **Brainsight->Preferences** (see Fig. 5-5).

Crosshairs colour: Refers to the colour of the crosshairs that indicate the location of the cursor. To change the colour, click on the colour box to open the colour picker to pick a new one.

Annotation highlight colour: An annotation can be a landmark, target or sample. When any of them are selected in any list, the 2D and 3D representations in any window are highlighted by a box that surrounds the object. The colour of the box is set by this preference. To change the colour, click on the colour box to open the colour picker to pick a new one.

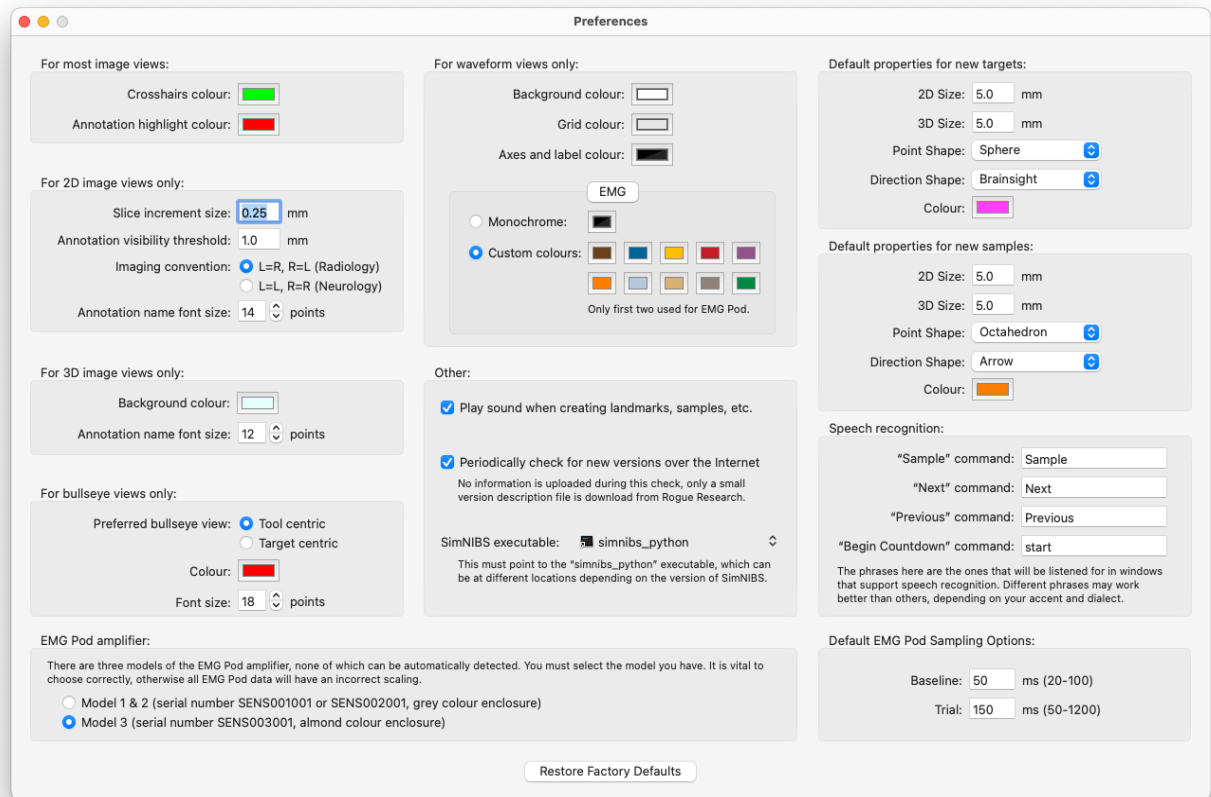

Fig. 5-5

Preferences Pane.

Slice increment size: When viewing a 2D plane it is possible to go from one slice to the other using the arrow keys or the mouse's scroll wheel. Each keypress of the arrow or movement of the scroll wheel will move the cursor the distance set by this preference. Change it by typing a new number in the box.

2D View annotation visibility threshold: When a marker location intersects a 2D imaging plane, the annotation is drawn on the plane. The threshold value determines how close to the plane the marker needs to be to be considered on the plane.

Annotation label font size (2D): This is the size of any labels associated with any annotation, when the relevant display option is active. Change the font size by entering a number, or clicking on the up/down arrows.

Imaging convention: When viewing 2D transverse and coronal slices, there is an ambiguity regarding which side of the image is the subject's left or right (this ambiguity dates back to when X-rays were viewed as translucent films placed on a light box). There are two conventions, often referred to as Radiology and Neurology for historical reasons. Radiology is the convention where the subject's right is displayed on the left of the screen and vice-versa. Neurology refers to the convention of the subject's right being on the right of the screen (think of it as looking at the subject's face, or the subject's back, or looking with the subject). Brainsight always displays an R symbol for the subject's right side (on the left when in Radiology convention, and on the right when in

Neurology convention), so you will always know which convention you are using.

3D Background colour: When Brainsight renders a 3D scene, the surrounding space (background) requires a colour. To change the colour, click on the colour box to open the colour picker to pick a new one.

Annotation label font size (3D): This is the size of any labels associated with any annotation, when the relevant display option is active. Change the font size by entering a number, or clicking on the up/down arrows.

Preferred bullseye view: In the session perform window, you can use a bullseye view to easily determine the location of the coil w.r.t. the target. The bullseye view has two modes, one being tool centric where the static crosshairs represent the tool's origin and the target icon moves on the screen as you move the tool, or target centric where the static crosshairs represent the target and the tool (e.g. TMS coil) icon moves as you move the tool

Bullseye colour: The bullseye view represents the tool in green (consistent with the cursor which often represents the location of the tool) and the target in another colour (default is red). You can change that colour here by clicking on the colour icon and selecting your preferred colour from the colour picker.

Bullseye text font size: The bullseye view includes a live text display of the target name and important position information including the current target name and the

linear, tilt and twist target error. You can make these more or less prominent by changing the font size.

Waveform Background colour The waveforms (e.g. EMG) can be drawn over your preferred background. It is usually good practice to consider the background colour in conjunction with the choices of the waveform colours as well to ensure they have good contrast with each other and do not interfere. Click on the colour box and select your preferred colour from the colour picker.

Waveform colours: The waveforms themselves can be viewed in any view either as a monochrome colour, or as colours with each channel having a different colour. Each colour can be individually set by clicking on them and selecting the desired colour from the colour picker. Note that in instances where there are more channels than colours, the colours will be repeated in the same order.

Play sound when...: When an event occurs (during a navigated session), Brainsight will often want to make a sound (some sort of beep) to notify you (as you might be focused on the subject and not watching the screen) when an important event occurred, for example when a new sample is acquired. There are times when it might be important for Brainsight to not make these sounds (but you may need the computer to make other sounds, so muting may not be an option). They can be deactivated by un-checking the box.

Periodically check for new versions over the internet: When launching Brainsight and this option is enabled, it will

anonymously ping our server to let you know if a new version of Brainsight is available. It is generally a good practice to keep Brainsight up to date unless you need to maintain a consistent version during a long term study. You can disable this feature by using this checkbox.

SimNIBS executable: If you have installed the SimNIBS current modelling platform and intend to use it within the Brainsight targeting step, you need to tell Brainsight where the executable (**simnibs_python**) is located (the default location is in your Users/UserName/Applications/SimNIBS-X.X/bin folder). Use the file selector to locate and record this location. Note that if you have multiple user accounts on your Brainsight computer, you should choose a universally accessible location when installing SimNIBS and note that each time you upgrade SimNIBS, you will need to update this preference.

Default properties for new targets: In Chapter 15, you will define targets for stimulation, and how they are to appear on the screen. When a new target is created, some default values are needed, and they are defined here. The **2D size** represents the size of the glyph when drawn on 2D planes (e.g. transverse), while the **3D size** determines the size when drawn in a 3D view (they are different because the nature of the displays often require different values for effective display). The **point shape** describes the shape of the glyph that indicates the location of the target. The **Direction shape** determines the shape of the glyph that indicates orientation (when the target is a trajectory, rather than a simple marker). The **colour** is the colour

to use when drawing the glyphs when the marker is not highlighted. Highlighted markers are always drawn in red to differentiate them from the others.

Targets are points that are set prior to a TMS session.

Samples are recordings of the location and orientation of the tool (e.g. TMS coil) during a navigated session. The default values for their appearance can be set here. The attributes are the same as for targets, so refer to the target preferences for a description of the individual attributes.

Speech recognition words: The default words for Brainsight to use during the subject registration step representing Sample, Next and Previous commands. Change the words by typing them in these fields.

Default EMG pod sampling options: Each EMG sample has a fixed duration and this can be set at any time during the navigated session where EMG is being acquired, but the default used can be set here. Baseline represents the time recorded before the trigger (e.g. TMS pulse) and the trial is the time recorded after the trigger.

EMG Pod amplifier: Brainsight now has 2 models of EMG amplifier. Set the model you have here. The model# is printed on the label on each amplifier. You can also use the colour of the case. If the amplifier is in a grey case, then it is model 2. If it is an almond case, then it is model 3. **Failure to select the correct model will result in incorrect EMG amplitudes being recorded or displayed.**

Chapter 6: The Overall Steps of Image-guided NIBS

INTRODUCTION

This chapter is intended for those who are new to neuronavigation. The general steps will be outlined and each step will be covered in more detail in subsequent chapters. Note that neuronavigation is useful in TMS as well as focused ultrasound (fUS), EEG, fNIRS and tES. This chapter will usually use TMS as an example, however it applies in the other uses as well and when the differences are important, the other modalities will be mentioned.

NEURONAVIGATION

Neuronavigation (often referred to as frameless stereotaxy or Image-guided TMS) can be described like a GPS system. A GPS system uses satellites to find the GPS unit on the earth. Software in the GPS unit translates the calculated position that are in latitude and longitude coordinates to coordinates on a map in the GPS' memory. The GPS uses this information to display a representation of the unit on the map. It is assumed that you are holding the GPS unit since we don't care where the GPS is unless it is attached to whatever we want to track (us, our car etc.).

A neuronavigator does the same thing. The satellite is replaced by a position sensor, usually an optical camera. The GPS antenna (that receives the satellite signals) is replaced by a tracker, in our case a small triangular shaped object with 3 or more reflective spheres on it. The map is replaced by anatomical images (usually MR images) of the subject. The navigation software communicates with the position sensor to obtain the location of the trackers (one on the TMS coil and one on the subject) and uses a registration matrix (obtained by identifying homologous anatomical landmarks on the images and the subject) to map the location of the TMS coil from the real world (as measured by the position sensor) to the image space. Once calculated, a representation of the coil can be displayed on the images. Stimulation targets can be identified in advance and the navigator can help you get the coil over the target.

Fig. 6-1
Overview of neuronavigation

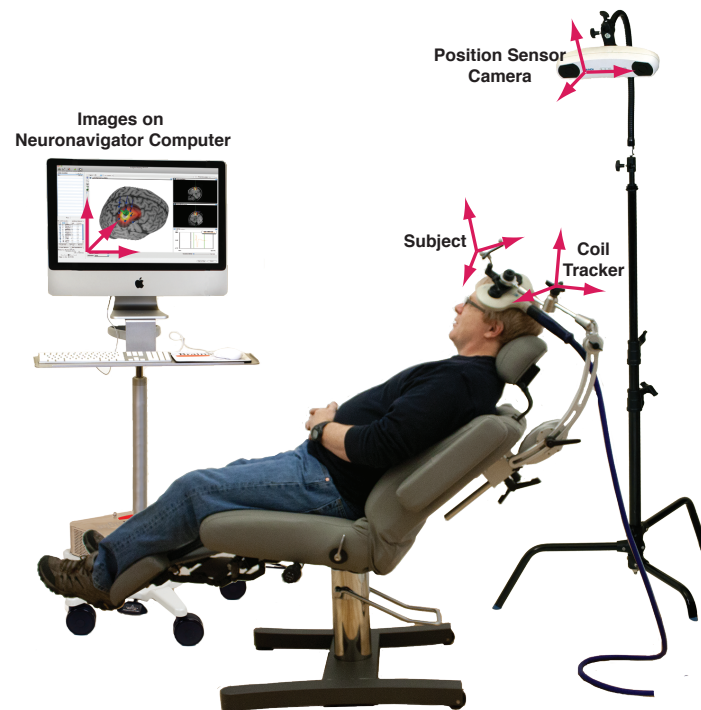

The overall layout of Brainsight 2 is designed to follow the typical steps involved in preparing and ultimately performing a TMS study. With the exception of the coil calibration, each tab along the top of the window represents one step in the process of getting ready for or carrying out a TMS session. The results of these preparations are stored in a Brainsight Project file. This file will contain links to the image data used as well as all the information you've input into the system. It will also be the repository for all data acquired during the TMS session(s) you perform using the project file.

The remainder of this chapter will introduce each step and how they are related. Each step will be explained in detail in the chapters that follow.

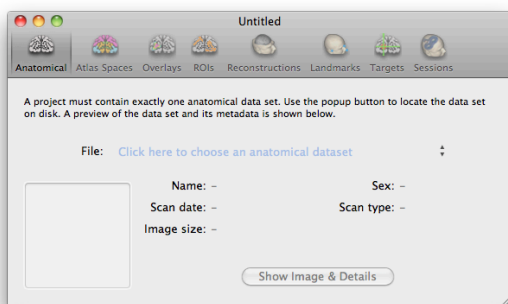

Fig. 6-2

Brainsight project window.

TYPICAL STEPS FOR IMAGE-GUIDED TMS

Calibrate your TMS Coil

The position sensor monitors the location and orientation of a tracker mounted on the coil. Additional information is needed to convert that position to the position of a point of reference for the coil (or the display of the coil's magnetic field). You will, under the software's direction, use a calibration tool to teach the computer where the reference point is on the coil.

Select the Anatomical Data Set

This is a short, simple step. You will select the anatomical image file(s). Currently, we support DICOM (and ACR-NEMA), MINC (both MINC1 & MINC2), Analyze 7.5, NIFTI-1, PAR/REC and BrainVoyager™ anatomical (.vmr).

Co-register to the MNI (and Talairach) Coordinate Space

This step is optional. If you wish to use MNI or Talairach coordinates as a source of target(s), then you need to co-register the individual subject's MR to the MNI coordinate space. You can do this by loading the matrix from MINC tools (e.g. using mritotal), typing in the matrix from SPM, or you can perform the registration manually in Brainsight.

Once the registration is performed, the images will not change (it is common in fMRI analysis to warp the individual's MR into MNI space for comparison) as we remain in "native" space. The transformation between the native MRI and MNI space (and by extension, Talairach

space) is kept in memory allowing the coordinates of the cursor to be expressed in native or MNI coordinates.

Select One or More Overlay Data Sets

This step is optional. If you are using functional data as a guide for targeting, you can load them in Brainsight and display them on both the 2D slices as well as the curvilinear reconstruction (described below).

Create a Region of Interest Using the Region Paint Tool

This step is optional. If you wish to highlight a particular region (e.g. motor cortex), use the region paint tool to paint the region in the anatomical (or any overlay) data. The region of interest will be visible in any of the 2D views, and can be used as the boundary to generate a 3D representation of it as well (see Perform 3D reconstruction).

Perform 3D reconstruction(s)

One of the most important features in modern image display software is the ability to display 3D representations of your data. This is especially useful in neuro-navigation where you are required to use the image display to position a tool in 3D over the subject's head. Brainsight currently supports two types of reconstruction: Surfaces based on voxel labelling (either automatically using intensity thresholding) or manual region painting, and curvilinear reconstruction.

The first is often referred to as a segmented surface mesh, or isosurface, where a surface (e.g. skin) is repre-

Fig. 6-3

A: Typical screenshot of the automatic skin segmentation.

Notice that the MR voxels of the head are highlighted in purple (as opposed to the “air” voxels as was the case in Brainsight 1), and the resulting skin surface.

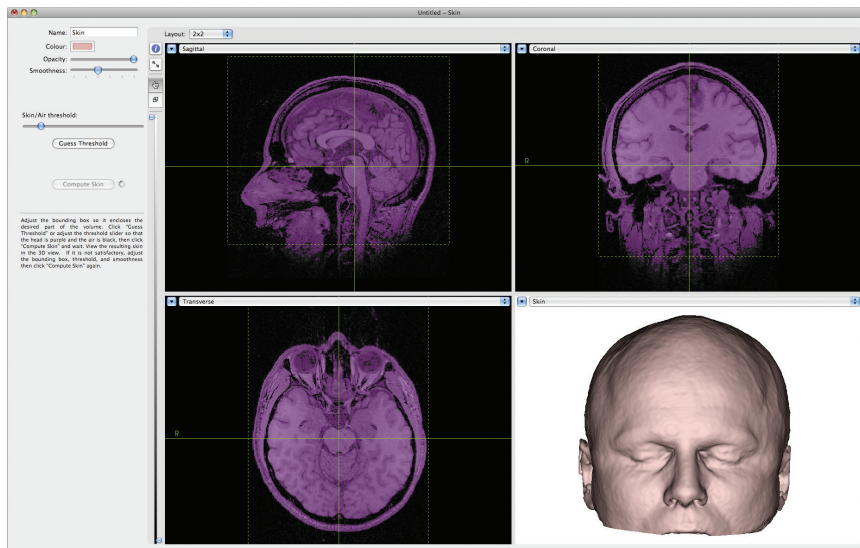

B: Curvilinear surface generated by the automatic curvilinear surface tool.

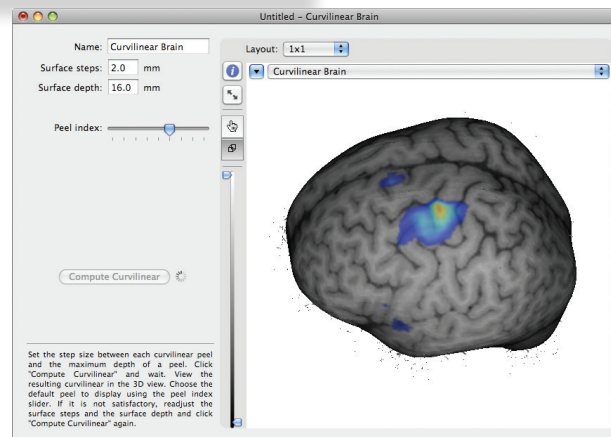

sented as a series of triangles generated by segmenting the raw MRI voxels (see Fig. 6-3a for an example of a segmented skin surface) based on a voxel intensity threshold.

The second reconstruction technique is called curvilinear reconstruction. This technique was originally developed for visualization of a class of lesions involved in Epilepsy called focal cortical dysplasia (see Bastos et al., Annals of Neurology, July 1999). The technique also proves useful for TMS because it allows for detailed viewing of the brain anatomy within the region of the cortical ribbon that is thought to be reached by TMS.

In short, a smooth surface representing the outer shape of the brain is generated along with a series of concentric surfaces (like the layers of an onion), and those surfaces are painted with the intensity values of the voxels that intersect that surface. By interactively peeling these surfaces, an excellent appreciation of the anatomy within the cortical ribbon can be obtained (see Fig. 6-3b).

Fig. 6-4

Close-up of the 4 typical anatomical landmarks.

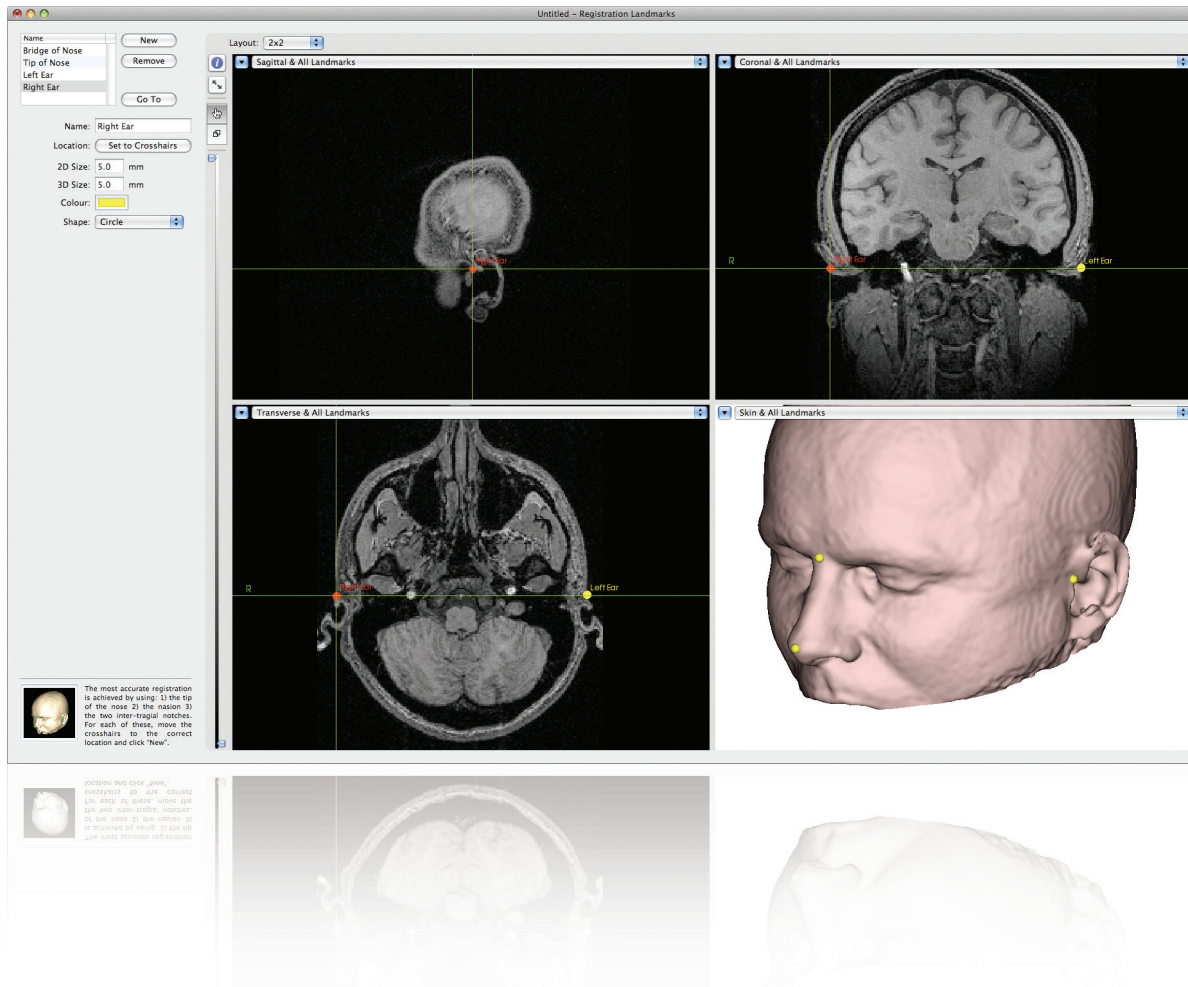

Select anatomical landmarks for registration

As mentioned earlier, co-registering the subject to the images is performed by identifying homologous points between the images and subject. The image version of the landmarks are identified in advance, typically by clicking on the landmark on the 3D skin and/or the 2D MRI slices, and recording the landmark.

Select your target(s)

Targets can be chosen using a variety of methods. The most straightforward is to visualize the target anatomically on the image display and record the location. If an MNI registration was performed, then MNI or Talairach coordinates can be used. Finally, if functional data is superimposed, then functional peaks can be used by clicking on a peak and creating a new marker at that location.

Targets can be recorded as a simple point (x, y, z), a trajectory (which is a point along with an orientation), or a grid of points for mapping exercises.

Current modelling can be used to calculate and visualize an estimate of the induced current in the brain from a given coil and position/orientation. This can assist in selecting the optimal coil position/orientation to preferentially stimulate a specific area while avoiding another.

Perform a TMS session

Once all the "homework" has been done, a TMS session can be performed. The session itself is performed as a sequence of steps. As with the main window, the steps for

a session are laid out as a sequence of buttons along the top of the window.

- 1. Prepare the setup.** Before starting the session (usually before the subject arrives), you need to set up your equipment. Much of the setup is dependent on the protocol for the experiment. In the context of the neuronavigation equipment, the setup involves making sure the position sensor camera is in a position to see the trackers on the subject, the coil (particularly when it is at the intended position on the subject) and the pointer in the various positions required to identify the landmarks.
- 2. Connect the equipment.** Brainsight 2 offers new features when connected to a supported TMS device via a serial port. For example, you can connect your Brainsight to any stimulator that has a TTL trigger out signal using a BNC cable to automatically record the coil location when it is fired. If you add a serial cable to the Magstim 200² or bi-stim device, Brainsight can communicate with the device to record the coil intensity for each pulse. More devices may be supported in the future as well.
- 3. Sit the subject and fix the subject tracker.** Once the apparatus is set, you are ready to begin the experiment. Place a subject tracker on the subject's head using either the head strap or the glasses. Place the subject in the chair (if you are using a chair).

- 4. Perform the subject-image registration.** Under the direction of the software, touch the same landmarks on the subject's head that were identified on the images. After identifying all the points, verify the quality of the registration by touching the scalp at different locations about the head and observe where they are on the computer screen.
- 5. Position the coil and stimulate.** Now, using the 3D brain, oblique 2D slices and the bull's-eye display, steer the coil to the target and begin your stimulation. During the TMS session, the location and orientation of the coil can be recorded (and other information in some cases), either manually or using the TTL pulses from the stimulator to trigger the acquisition. These are referred to as coil samples.
- 6. Acquire physiological data** (optional). If you are using our EMG and/or supported EEG and/or NIRS device, then you can record data during the TMS session (e.g. EMG at each pulse).

Review the acquired data

After the TMS session, you may want to review the data acquired. For example, you may wish to look at the recorded TMS locations to see how they correlate with the stimulus results, verify that the intended targets were indeed stimulated for quality assurance purposes, or pick selected recorded TMS locations for use as targets in future TMS sessions. If you acquired EEG or NIRS physiological data during the acquisition, you can export the data in file formats common to that modality (e.g. EDF+

for EEG and ".nirs" for NIRS).

Chapter 7: Calibrating Your Tool

Brainsight tracks your tool (TMS coil or fUS transducer) using a small triangular shaped (3 spoke) device called a tracker. A tracker has three or more reflective spheres in a distinct formation. The distinctness allows the position sensor to distinguish the tool tracker from the subject tracker (despite their similar appearance) and other tracked objects. Brainsight needs additional information in order to be able to display the tool's position given the position of the tracker attached to it. This information is the offset from the tracker to the coil's **reference point**, usually associated with the point thought to be at the coil's maximum output, often referred to as its **hot spot** when tracking a TMS coil, or the central axis of a fUS transducer. The procedure to obtain this information is called calibrating the tool.

PLACING THE TRACKER ON THE TMS COIL

The tracker is fixed to the coil using a short, hexagonal rod and a coil specific adapter that accepts the rod. The tracker is attached to the fixation adapter using a short hex rod. Receptacles for the hex rods are found under the tracker and on the fixation adapter. The receptacles have one or two set screws that are used to fix the hex rod in the receptacle. While attaching the tracker to the coil, take into consideration the orientation of the tracker while keeping in mind the expected location of the coil and the position sensor camera (see Fig. 7-1).

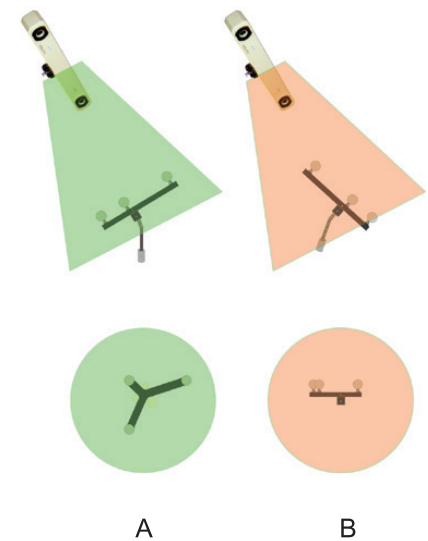

Fig. 7-1

Coil Calibration Manager.

Coil-Specific Tracker Adapters

The coil tracker is attached to the coil using a coil specific adapter, taking into account the shape and design of each coil type. In addition, if you are using our Gen 4 subject chair, you may have a combination tracker mount/coil arm fixation mount adapter. In these cases, the adapter will have both the tracker mount and receptacle for the coil holder arm. In general, coil tracker adapters need to be rigidly attached to the coil in such a way as to enable the tracker to be well positioned for visibility, be rigid (not move accidentally), not impede normal use of the coil and not damage the coil.

Coil winding hole: When the coil has holes in the winding, a plastic “plug” can be attached to the hole. This method has the advantages of placing the tracker over the top of the coil itself which is the optimum location.

Coil handle: When the coil does not have a hole, then the handle may be an appropriate place to use a ring style adapter. Coil rings for several coil models are available. The main drawback is that the coil handle may be made of a soft material, making it difficult to rigidly attach the ring. It is advisable to re-calibrate the coil often when coil rings are used in case the tracker ring slips without being noticed.

Fixed to another feature of the coil body: In some coils, there are no handles (or appropriate ones) nor are there holes. In these cases, another method is used. For example, the Magstim air-film coil has a specific adapter that uses the mounting points originally intended for the 2 handles.



For three generations of Magstim figure-8 coils (the beige 1st generation, model 9925, blue 2nd generation model 3190 “remote” coil, and 4102 D702 coils) have plastic inserts that fit into either hole. To install, place the upper half into the hole (either one is ok), then the lower half under the coil. Use the plastic bolt to fix both halves together. **Be careful not to overtighten the plastic bolt** (it is plastic, not metal!). When present, be sure to align the flat, thinner part of the lower adapter towards the middle of the coil to prevent the disk from touching the head.

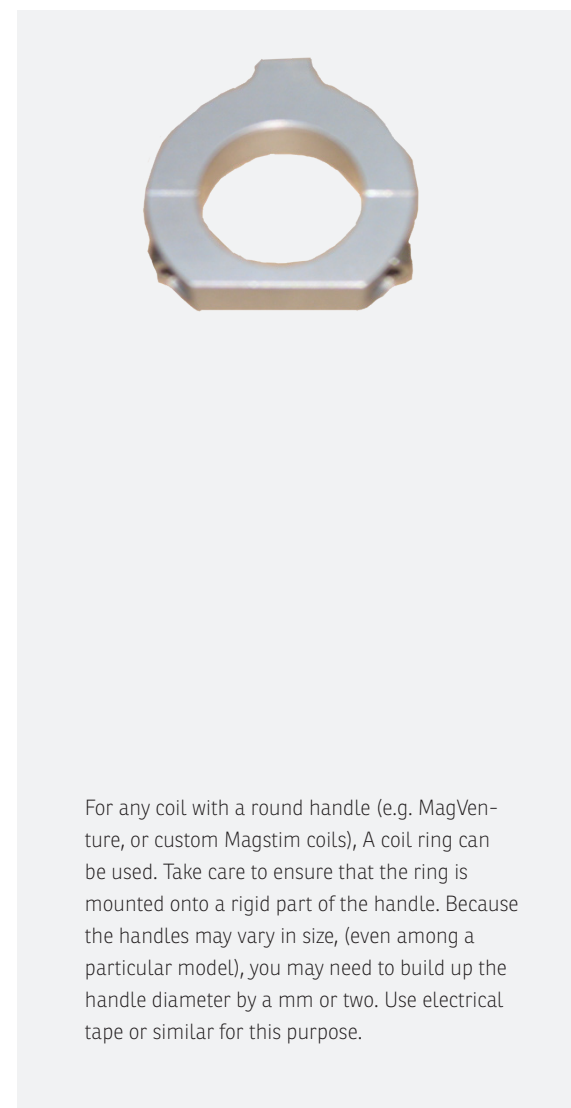

For any coil with a round handle (e.g. MagVenture, or custom Magstim coils), A coil ring can be used. Take care to ensure that the ring is mounted onto a rigid part of the handle. Because the handles may vary in size, (even among a particular model), you may need to build up the handle diameter by a mm or two. Use electrical tape or similar for this purpose.

The adapter for the **Magstim air-film** coil uses the mounting points for the handles as a rigid hard-points. This requires that the coil be partially disassembled to remove the handles. Once the handles are removed, the adapter is placed in the holes for the handles, and using longer screws, the original handles are replaced into holes on the top of the adapter and the assembly is held together using the longer screws that go out of the coil, through the adapter and into the handles. Note that this procedure should be performed by authorized personnel. Contact Rogue Research or Magstim for details.



If you have the **Brainsight Gen4 subject chair** and coil arms, you will likely be using a different type of tracker adapter for your coil. The new chair uses a new method of fixing the coil to the arm, improving the ease in orienting the coil while being held by the arm. The new arm uses coil-specific adapters to attach the coil to the arm, and in many cases, the adapter includes an integrated coil tracker fixation sleeve.



The tracker is attached to the fixation adapter using a short hex rod. Receptacles for the hex rods are found under the tracker and on the fixation adapter. The receptacles have one or two set screws that are used to fix the hex rod in the receptacle. While attaching the tracker to the coil, take into consideration the orientation of the tracker while keeping in mind the expected location of the coil and the position sensor camera (see Fig. 7-1).

- Loosen the set screws on both the tracker and the adapter, taking care that the screws don't come out completely.
- Insert the hex rod into the receptacle of the coil adapter. Make sure that a flat section of the rod is

aligned with the set screw(s). and using the 1/16" hex tool, tighten the set screw(s).

- Insert the tracker onto the other end of the hex rod. Make sure that a flat section of the rod is aligned with the set screw(s). and using the 1/16" hex tool, tighten the set screw(s).
- Check that the hex rod is secure at both ends by lightly trying to twist the tracker.

MANAGING TOOL CALIBRATIONS

Brainsight manages the tool calibrations with an internal database. You do not need to worry about file names or locations. You simply need to give the tool a name that fits your needs, and match that to the tracker attached to the coil. Select **Window->Tool Calibrations** to open the tool calibration manager window (Fig. 7-2). The calibration manager allows you to create new tool calibrations, re-calibrate existing ones and remove old calibrations. It also allows you to export the calibration matrix as a tab delimited text file.

- To remove one or more calibrations, select it from the list of existing calibrations and click **Remove**.

Fig. 7-2

Coil Calibration Manager.

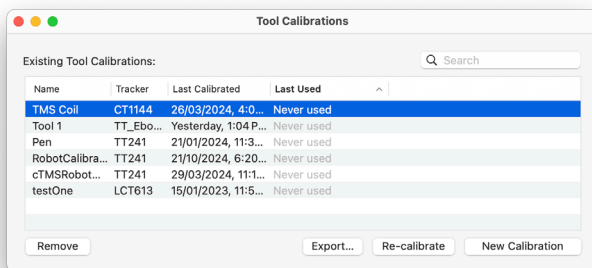

- To re-calibrate, select the calibration from the list of existing calibrations and click **Re-calibrate**.
- To create a new Calibration, click on **New Calibration**.
- To export a calibration to a text file, select it from the list, click **Export...** and use the file save dialog box to navigate to the desired folder, enter a file name and click **Save**.

PERFORMING A TOOL CALIBRATION

As with earlier versions of Brainsight, you calibrate your coil using the calibration block provided with your Brainsight tools. While the user interface has been improved,

Fig. 7-3

Coil calibration window.

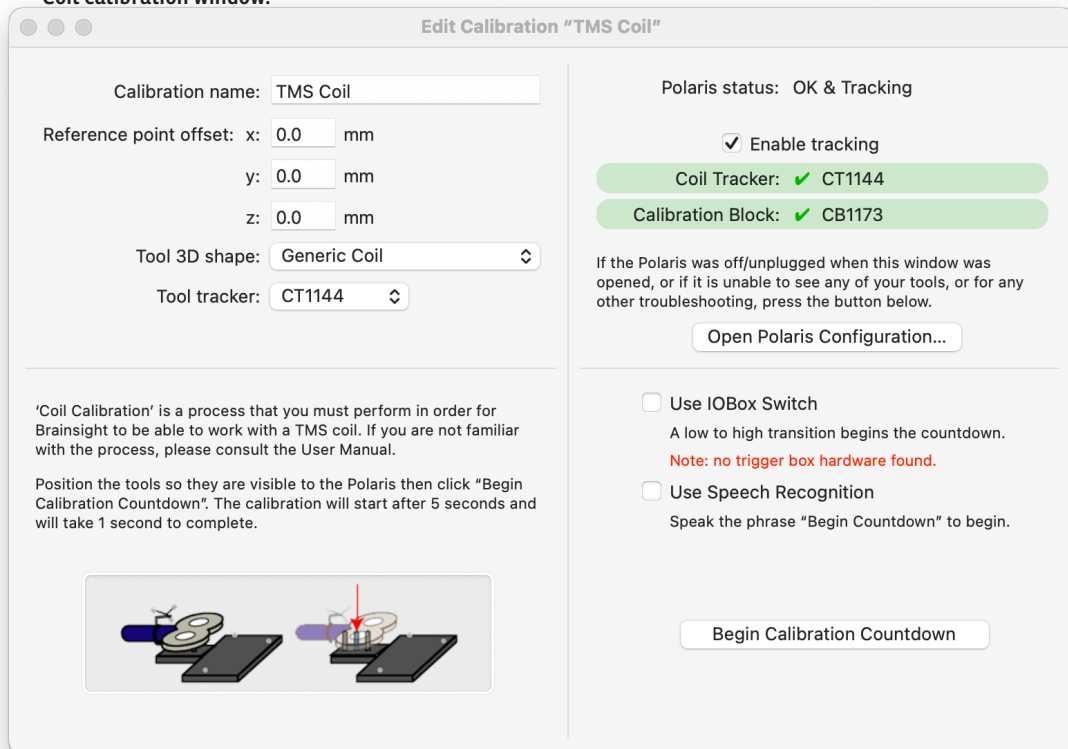

the calibration procedure is relatively unchanged. If you clicked on either Re-calibrate or New Calibration, the window illustrated in Fig. 7-3 will open.

- Make sure you have a tracker fixed to the tool, and that the orientation of the tracker will be optimum for the expected orientation of the tool during the NIBS session with regards to the camera orientation (Fig. 7-4).
- Place the calibration block on a table and move the Polaris camera to ensure that the block's spheres are in the camera's field of view. Alternatively, if you are using the head and coil holder apparatus, you can install the mounting pin on the bottom of the calibration block, and place the block in the receptacle used for the chin rest (Fig. 7-4). This has the advantage of already being within the camera's



Fig. 7-4

A: Mounting pin to allow you to mount the calibration tool to the chin rest receptacle on the subject chair.

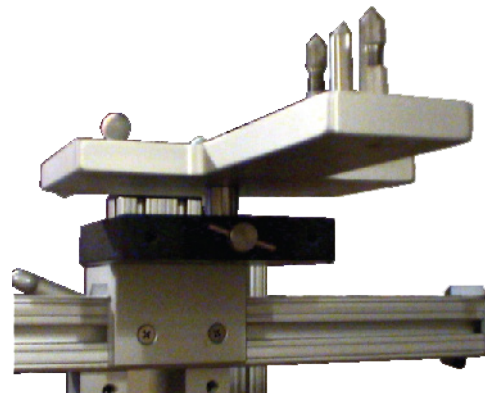

B: Calibration block in the chin rest receptacle.

Fig. 7-5

Close-up of the reference indicator pin and the two stabilizer pins. Note that new types of stabilizer with wider depth stops were introduced and are used for the recently introduced calibration jigs (see next page).

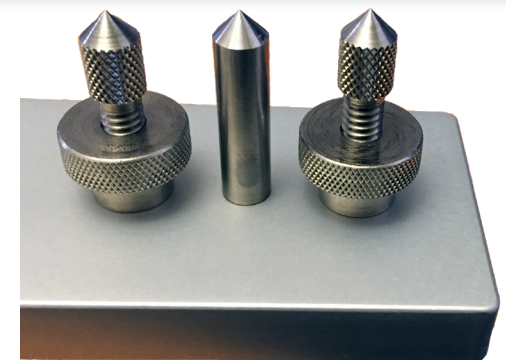
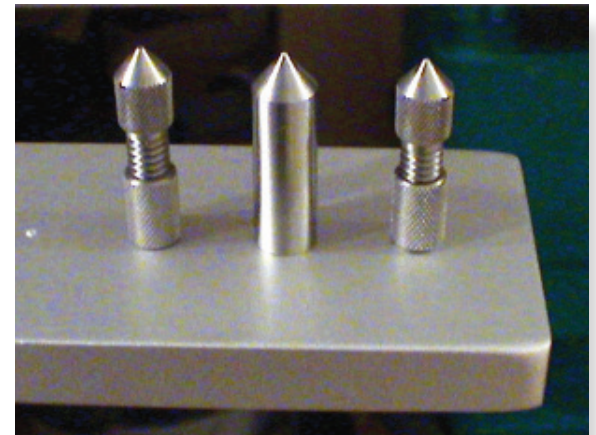

field of view (or relatively close) as the camera would typically be placed to see the subject's head.

- Examine the alignment pins on the block (Fig. 7-5) to make sure the two outer stabilizing pins are well adjusted for the shape of the coil.
- Referring back to the calibration window, give the calibration a name, which will be used to refer to it in the software (e.g. "fig 8 coil", or simply "coil", or if you plan on tracking two coils at the same time, "coil A").
- If you have one tool tracker, the correct one should already be displayed in the **Tool Tracker** popup button. If you have multiple trackers (to track 2 coils at once, for example), select the tracker that is attached to the coil from the popup menu.
- If desired, enter an x, y, z offset for the reference point. This would allow you, for example, to move the reference point to a location other than the location touched by the reference indicator pin, for example the location of the fUS focal point. See Fig. 7-7 for an illustration of the coordinate system for the offset.

If you have a calibration jig for your tool (Fig. 7-6)

- Ensure that the depth stop screws are the ones with the wide, flat section (see Fig. 7-5), and that they are screwed all the way down as they act as the platform to support the jig.
- Select the calibration jig appropriate for your model

Fig. 7-6

Rogue Research recently introduced calibration jigs to simplify the calibration procedure. They consist of plastic inserts that fit into the calibration block and have coil specific shapes etched on the surface. The coil simply slips into the jig and can easily be held in place with one hand. Contact Rogue Research for more information.

A: Calibration jig for a common coil (Magstim 9925 or Alpha coil) on the adapter.

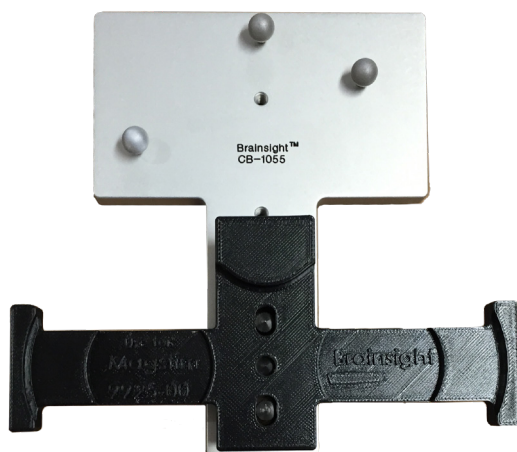

B: Coil placed in the jig for calibration.



of TMS coil or fUS transducer, and insert it on the jig.

- Place the tool onto the jig.

If you do not have a calibration jig:

- If you have an assistant, have one person hold the coil and place it on the calibration block such that the centre pin (the reference spot indicator) is touching the “hot spot” of the coil. Take care to ensure that the coil is straight and level.

The orientation of the tool on the calibration block will dictate the orientations of the inline and inline-90 view planes (see Fig. 7-7). Alternatively, use the articulated arm to hold the coil and place the coil as described on the reference indicator. **It is very important to be precise. Any error in positioning will translate into a systematic error in tool positioning.**

The next step will be to initiate the calibration measurement. Once the calibration has been triggered, a 5 second countdown will occur to give you time to steady the coil. The countdown can be initiated using one of 3 methods:

- 1: enable voice recognition (click **Use Speech Recognition**) and say “begin countdown”;
- 2: On older iMac computers and laptops (mid 2011 or older) that support the IR remote (not the AppleTV remote), enable the Apple remote (by clicking **Use Apple Remote**; and pressing the Play button. Note that the remote works best when not in the field of view of the position sensor camera,

or having the camera face the computer as the camera’s IR output can interfere with the reception of the remote’s signal.

3: Click **Begin Calibration Countdown**. The software will count down 5 seconds to give you time to steady the coil (helpful if you are alone and have to click and then quickly place the coil). After the countdown, the appropriate measurements will be performed (will take about a second) and the calibration will be complete.

- Close the window by clicking the close button (the

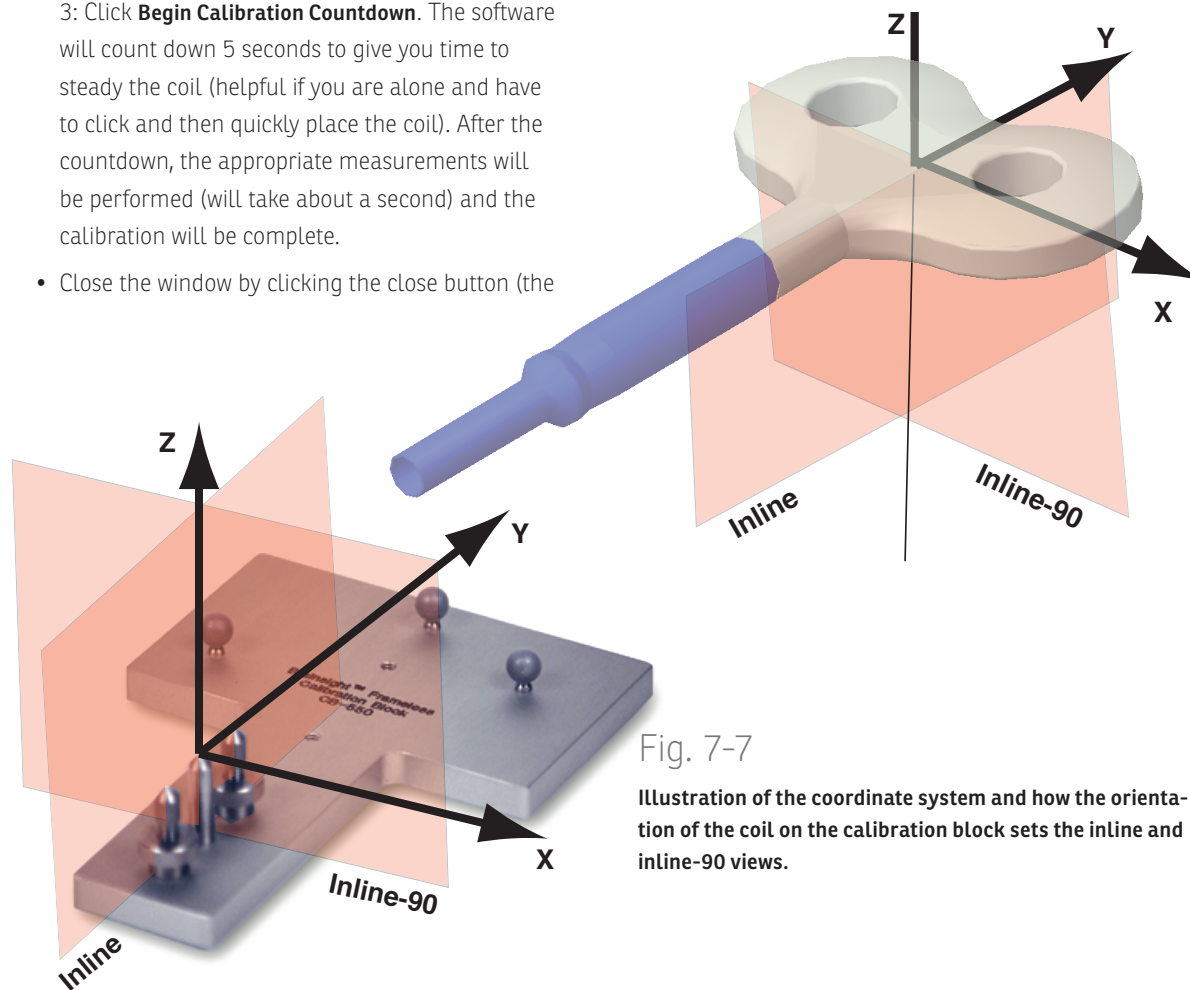

Fig. 7-7

Illustration of the coordinate system and how the orientation of the coil on the calibration block sets the inline and inline-90 views.

top left button).

SPECIAL CONSIDERATION FOR fUS TRANSDUCERS

When using a focused ultrasound (fUS) transducer, it is important to understand the relationship between the physical transducer, the location of the transducer focus and the location on the crystal from where the focal distance is measured. When the transducer is calibrated, the calibration plane is defined by the part of the transducer that is physically resting on the calibration jig. This location is almost certainly different than the plane from which the focal distance is measured. Review the fUS documentation or contact the transducer manufacturer to obtain this information.

You can decide where you wish to define the tool origin within Brainsight. This decision will dictate where the cursor is placed in the Brainsight display (observed during the NIBS session) and in general, the three strategies to set the origin are to set the origin at the calibration face, the top of the curved crystal or at the virtual focal point.

At the calibration plane

Choosing the calibration plane is the simplest option in the calibration step, however care is required when projecting from this point to estimate the location of the hot spot of the transducer relative to this point. Referring to Fig. 7-8, the focal point will be $f-d$ away from the calibration plane. To view that location when tracking the transducer, you can use the offset slider (in the perform

Fig. 7-8

Important variables to consider when calibrating a fUS transducer

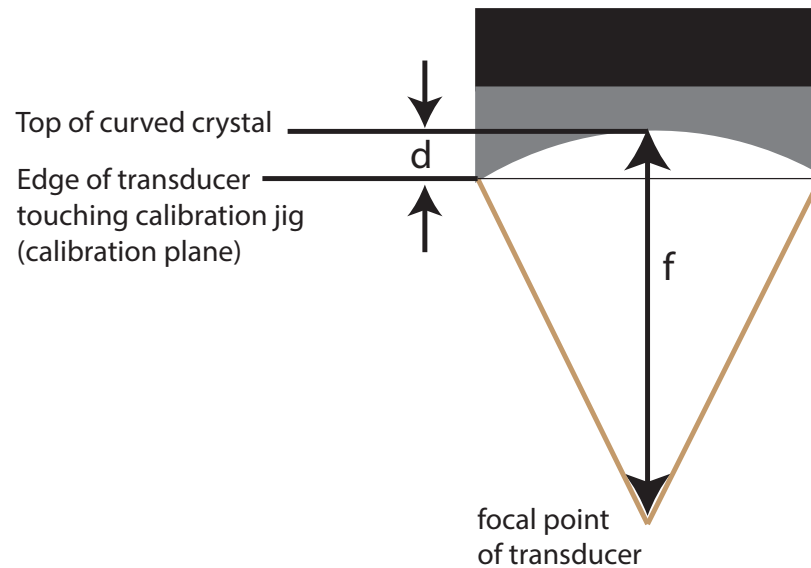

step) by setting the value to $f-d$.

At the top of the crystal

This is likely the most reasonable strategy to set the tool origin, if the value of d is known. Enter the negative of d in the Z component of the tool offset (see Fig. 7-3). The location of the cursor will be slightly above the calibration face (offset by the distance d).

At the focal point

Finally, the origin of the tool can be set to the location of the hot spot of the transducer. Since the physical edge of the transducer is certainly below the top of the curved crystal, enter the value of $f-d$. When the transducer is placed on the head (during the NIBS session), then cursor origin will be at the location of the focal point (in the head) rather than indicate the location of the transducer itself.

Chapter 8: Importing Brainsight 1.7 Projects

The internal file format for Brainsight projects has changed significantly since version 1.7. Brainsight 2 supports opening these older projects so you can both visualize the data acquired with 1.7 and use the data for new TMS sessions. When opening an older project, it will be converted to a Brainsight 2 project, leaving the original project unchanged.

MAPPING THE OLD TO THE NEW

When opening an old project, all the data is mapped from the old representations to the new ones, which can take a few minutes, particularly if the project has several curvilinear reconstructions and your computer does not have a lot of RAM (e.g. less than 2 GB). The good news is that this needs only be done once for a project.

Importing the Project into Brainsight 2

- Launch Brainsight 2.
- Select Open Project from the File menu, and select the Brainsight 1.7 project.
- After a period of time, the project importer window will appear (Fig. 5-1).
- Markers and trajectories from the old project will be listed on the left, and receptacles for anatomical landmarks, targets and samples will be shown on the right. All the markers and trajectories on the left need to be sorted into landmarks, targets and samples for Brainsight 2 projects (review chapter 3 for these concepts). If you used standard names for the anatomical landmarks, they will automatically be copied into the landmarks list on the right. Otherwise, select the landmarks from the list on the left and click **>Landmarks** to copy them over, or simply drag and drop them from one list to the other.

- Select any targets from the list on the left, and click **>Targets** to copy them to the target list (or drag and drop them).
- Select any samples from lists on the left and click **>Samples** to copy them to the samples list (or drag and drop them). These will be placed in a single TMS session entry in the new project.

Note that Brainsight 2 removes the ability to set the highlight colour as it is always red. Any highlight colours from the 1.7 project will be ignored.

Fig. 8-1

Brainsight 1.7 project importer window.

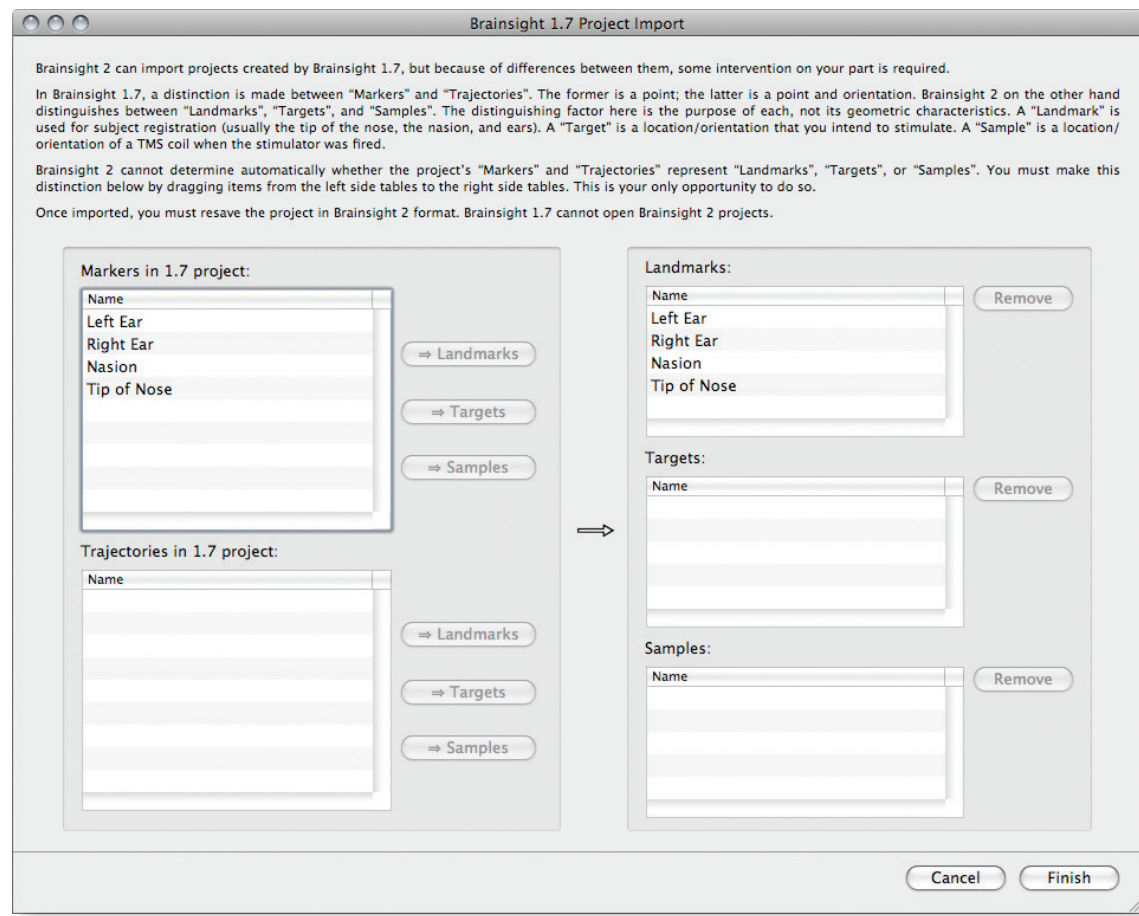

Chapter 9: Loading Anatomical Images

The anatomical images form the basis for the coordinate system onto which all data is registered to. For example, fMRI data is co-registered to it and overlaid. The subject's head (in the lab) is co-registered to the images to allow the display of the TMS coil or fUS transducer on the images. For this reason, loading anatomical images is the first step in preparing your project.

Brainsight supports the use of your subject's specific MRI (recommended), or in the cases where the subjects MR images are not available, a template Brain (ICBM 152 average brain). The subject-specific MR images are preferred because they will be the most accurate for targeting, however in some cases, using the model brain may be sufficient, particularly when reproducibility is the main goal. This may be the case when the target is found during a pilot session rather than from the images directly (e.g. motor based target).

INTRODUCTION

When Brainsight is launched and you click "I agree" to the licence statement, a new shortcut assistant window will appear. You can either open or create a project, configure your hardware or initiate common tasks such as calibrating your tool or digitize an EEG cap. You can by-pass the assistant window at any time by selecting the same options from the appropriate menu.

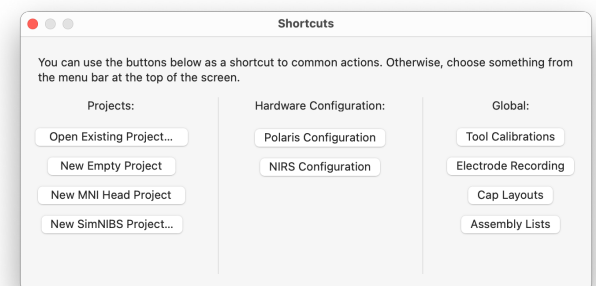

Fig. 9-1

New Shortcut Assistant Window

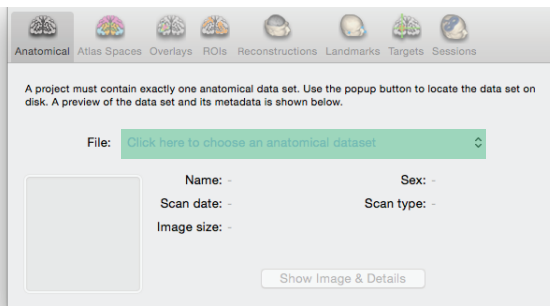

Fig. 9-2

Click on the file selector box (highlighted in green) and select **"Choose..."** from the popup menu.

OPENING A PREVIOUSLY SAVED PROJECT

Click **Open Existing Project...** in the New Project Assistant Window, or select **File->Open Project...** When the file selector window opens, navigate to, and select the desired project to open. If the project was recently opened in Brainsight, you can use a shortcut by selecting the project file directly from the **Open Recent Projects** menu.

CREATING A NEW PROJECT USING SUBJECT-SPECIFIC IMAGES

- Click **New Empty Project** in the New Project Assistant window, or select **File->New Empty Project**. A new, untitled project window will appear.

- Click the file chooser (the section highlighted in green in Fig. 9-2) and select **"Choose..."**, from the popup button. A file selector dialog will appear. Note that you do not need to identify the file format as Brainsight will figure this out automatically. Do the following for each supported file format:

- MINC: Select the MINC file by either clicking on the file and clicking **Open**, or by double-clicking the file.
- Analyze (and hdr/img type NIFTI files): These files come in pairs. The header (using the .hdr extension), and the image data file (with a .img extension). Select either file by either clicking on one of them and clicking **Open**, or by double-clicking the file. The image file will be opened automatically.

- NIfTI files (using the .nii extension): Select the NIfTI file by either clicking on the file and clicking **Open**, or by double-clicking the file.
- DICOM CD: If your DICOM images came on a DICOM CD, use the free application "Horos" (<https://www.horosproject.org>) or other suitable DICOM reader to read the CD and extract the desired scan. Follow the Horos instructions for more details, or follow the instructions in Fig. 9-5).
- DICOM files: All the files for the data set must be in the same folder prior to opening the images.

Select any slice of the volume and click **Open**. Brainsight will search the folder for remaining slices from the scan and load them.

- PAR/REC: These files come in pairs. The header (using the .par extension), and the image data file (with a .rec extension). Select either file by either clicking on the file and clicking **Open**, or by double-clicking the file. The image file will be opened automatically.
- BrainVoyager VMR (versions 1-4): BrainVoyager typically performs several image processing steps to convert the native space images into normalized (MNI) space and stores intermediate images. Use the AC-PC aligned images (but not scaled) by selecting the appropriate .vmr file.

Note about DICOM CDs. It is common to receive DICOM files on a CD-ROM formatted in a common DICOM standard. The CD often contains multiple scans and it is difficult to extract the files associated with the desired scan. We recommend using a free application called OsiriX to read the DICOM CD. The software will read the CD and display a list of scans on the CD (it may take a few minutes to scan the disk and build the catalogue. Simply select the scan from the list, click the "Export" button and select the destination for the scan on your hard disk.

Once the images load, a thumbnail of the scan will appear on the project window along with some details extracted from the header (Fig. 9-3). You can proceed to

the next step, or view the metadata in the header as well as the image volume by clicking the **Show Image & Details** button, which will open a viewer window (Fig. 9-4).

CREATE A NEW SIMNIBS-BASED PROJECT

Brainsight now supports integration with the SimNIBS current modelling environment (SimNIBS 4). To create a new project with the intent of using SimNIBS current modelling, generate a standard SimNIBS pre-processing data set (a folder with several items including a segmented version of your subject's MRI generated using the SimNIBS charm function. Click New SimNIBS Project and at the prompt, navigate to the location of the .msh file in the SimNIBS subject-specific simulation folder and select it. It is important that the contents of the folder remain as created by SimNIBS.

Note that the SimNIBS-based project will also load the 3D segmented objects including skin, grey and white matter as well as other anatomical structures needed for

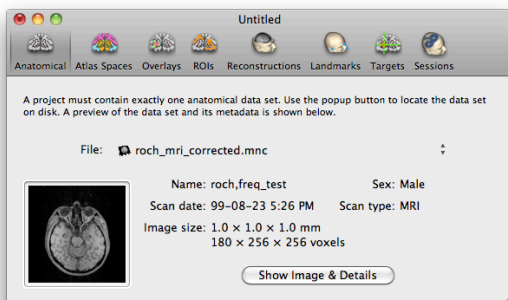

Fig. 9-3

Project window with the anatomical MR scan loaded.

Fig. 9-4

Anatomical Image Detail View

In addition to showing the usual tri-planar images, the files header information is also kept and shown in detail.

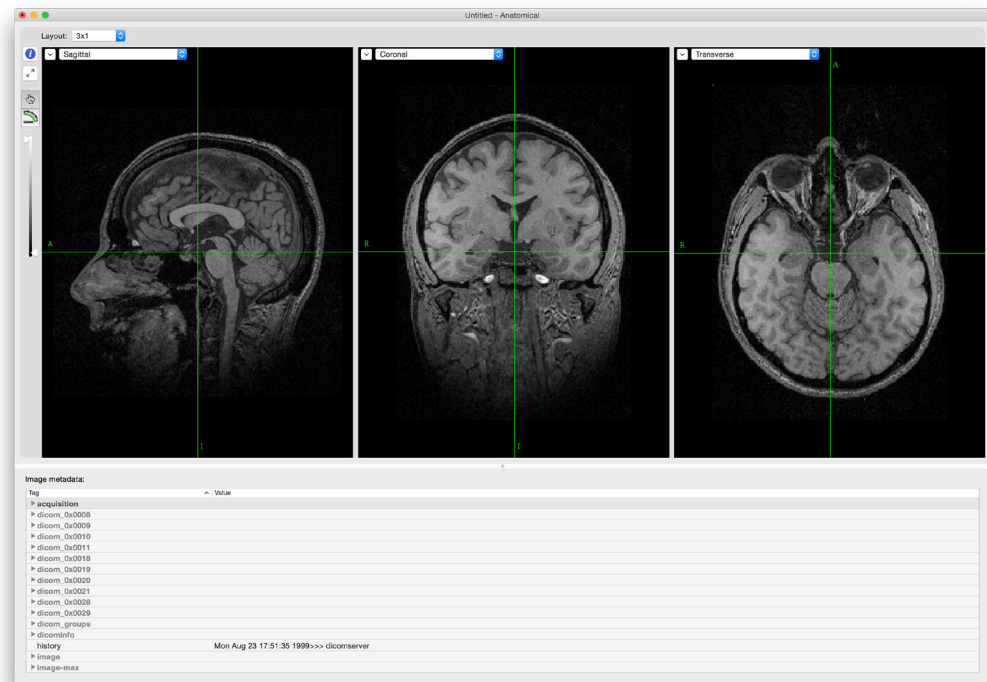
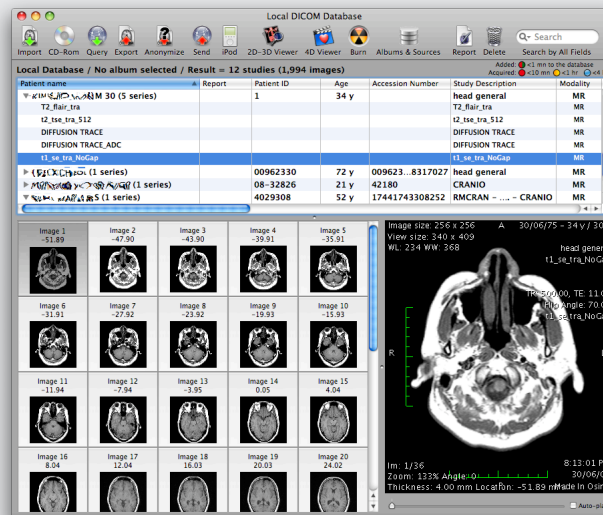
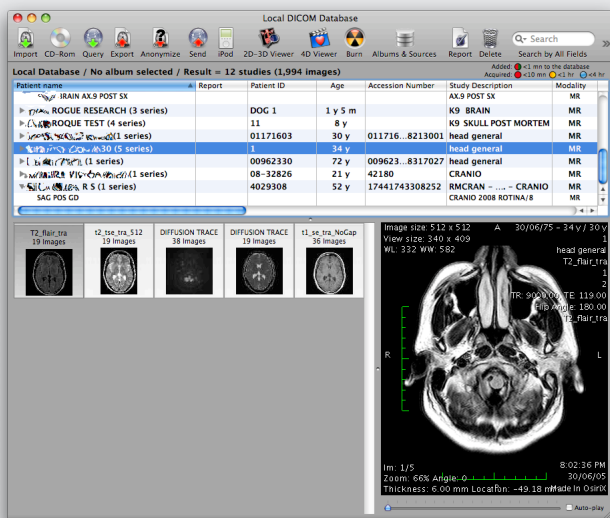

Fig. 9-5

Typical steps for importing DICOM images from a DICOM CD using the Osirix or Horos apps.

A: Launch Horos and insert the DICOM CD. Wait for the CD to be read, or press the CD button at the top of the screen to have Osirix scan and load the imaged from the CD (or drag the CD icon from the desktop onto the Osirix window). It may take a few minutes to scan the CD and load the images.



B: Select the scan that you wish to use (make sure it is selected in the list view and that the thumbnail images from the scan appear in the lower left view box) and click Export.

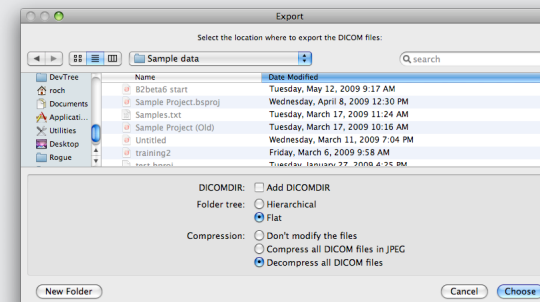

C: Select "Flat Folder" and "Decompress all DICOM files". Navigate to your image folder, and press Choose. Osirix will extract and save the scan in a folder using the subject's name and scan number.

the current simulation.

Note: While earlier 2.5beta versions of Brainsight supported SimNIBS 3, Brainsight 2.5.0 (non beta) supports SimNIBS 4, mainly due to the changes in how the files generated by the SimNIBS reconstruction pipeline (charm vs. headreco). If you have Brainsight projects created with one of the 2.5b versions, use the migration tool provided with SimNIBS 4 to migrate the SimNIBS generated files to the SimNIBS 4 format, then open the project in Brainsight.

CREATE A NEW PROJECT USING THE MODEL HEAD IMAGE SET

When MR images are not available, it may be appropriate to use a template head. Brainsight incorporates the MNI 152 average brain for this purpose (<http://www.bic.mcgill.ca/ServicesAtlases/ICBM152Lin>). Be sure to have downloaded and installed the “Support Files Human” (version 1.7 or newer) from our web site (the same way you download Brainsight updates). The MNI 152 is a template based on the average of 152 individual subject MR images that were co-registered to the MNI coordinate space and averaged.

To use the average brain template:

- Click **New MNI Head Project** from the New Project Assistant window (Fig. 6-1), or select **File->New MNI Head Project**. The data set will be loaded automatically.

Fig. 9-6

Project window with model head selected

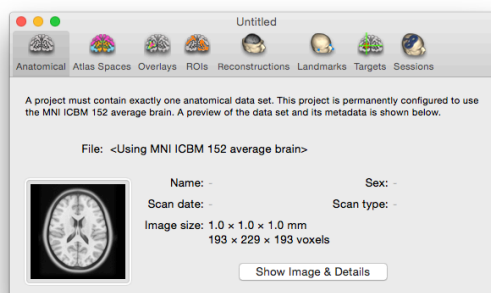

“Chapter 15: Selecting Targets for Stimulation”.

WHEN TO USE THE MODEL HEAD VS. SUBJECT-SPECIFIC MRI?

Making the choice between using (and often paying for) subject-specific images vs. a model head can have significant impact on the accuracy and reliability of your study. In general, using a model head is best reserved for the following cases:

- The target will be based on a pilot study or by observing an external response (not by interpreting the anatomical images).
- Reproducibility is the main goal of using navigation (reproducibility vs. specificity).
- Anatomical targeting accuracy of about 10 mm is

Note that the data summary pane shows the image resolution and voxel count, but not the name (there is no name stored in the MNI 152 average brain image file).

The MNI Head project already has a 3D skin, brain surface and brain curvilinear reconstruction, so unless you wish to create additional surfaces, you can skip to

sufficient.

Subject-Specific MR images should be considered in cases where:

- Targets are based on subject-specific anatomy.
- Targets are based on a functional overlay (e.g. fMRI).
- No external measure of target correctness is available.
- Anatomical targeting accuracy of about 3 mm is required.

THE IMAGE DISPLAY WINDOW

The image display window, as the name implies, is the main method of displaying image data. The exact configuration of the window depends on the context of the display (i.e., what step in the process you are in). The relevant controls are shown in Fig. 9-7. The example window shown in Fig. 6-7 is taken from a later step in the data processing workflow (the skin segmentation step) as it shows tools that are normally found throughout the software, with the exception of the anatomical detail view window (due to its simplicity).

Different perspectives of the image data are displayed in individual views, called (to no surprise) Image Views.

Layout Control

Each display window starts in a default layout configuration. In the example of Fig. 9-7, it is a 2x2 layout. The layout can be changed using the layout control popup menu.

View Configuration (HUD)

Configure each image view (if desired) by clicking on the HUD button (we call it a HUD, for Heads Up Display because the window floats over the image view when invoked). When viewing a 2D image, you can change the zoom (note that the zoom applies to all 2D views); while viewing a 3D image, you can also change the view's orientation. In a graph view (e.g. EMG), a zoom controller allows you to set the vertical and horizontal scale.

Note: Many image manipulations are performed without

Fig. 9-7

Typical image view window with the important controls highlighted in green.

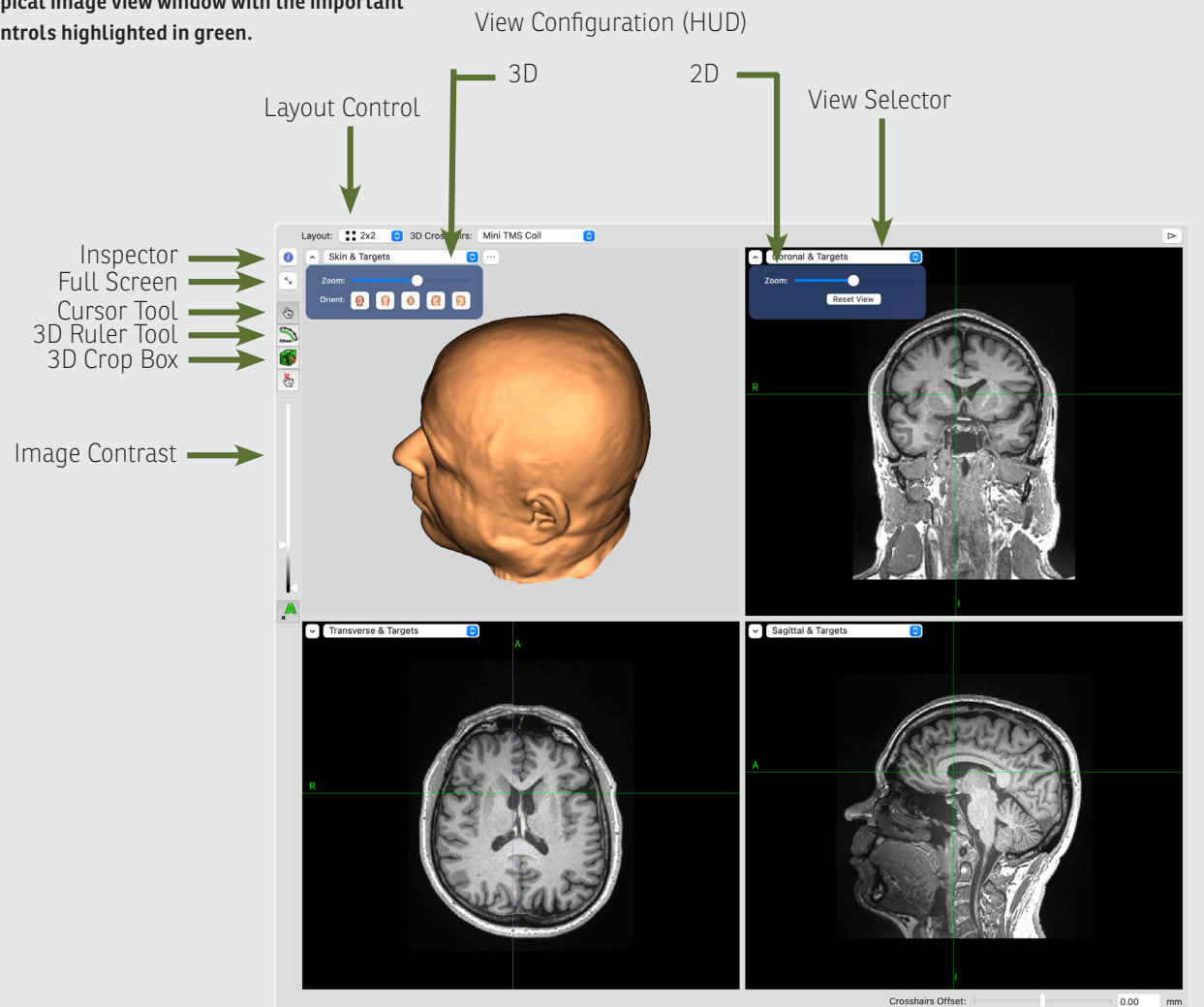

needing to invoke the HUD. For example, option-click-dragging the image performs panning, while option-scroll wheel zooms the image. Zooming a 2D image view will apply to all 2D images, while zooming in a 3D or graph view only applies to that view. Panning always applies to the single view only.

View selector

You can change what is being displayed by clicking on the view selector. A series of common views and a customize option are listed, where you can select exactly what you wish to view from an array of options.

Inspector

Invoking the inspector opens a control window that allows you to change certain context sensitive window settings and the appearance of ROI (Fig. 9-10A) and overlay image data (Fig. 9-10B). From this window, you can also choose the peel depth of curvilinear reconstructions (Fig. 9-10C).

Full Screen Control

This button toggles the view window in/out of full screen mode. You can use full screen mode if you want to maximize the amount of screen space used for image display.

Cursor Tool

The new “smart” cursor tool replaces the multiple tools found in Brainsight 1 with gesture interpretation to determine your intent when clicking the mouse. When clicking the mouse on the images, one of several things

may occur depending on the context of your motion:

- Single-clicking (without motion) on the image moves the cursor to that location (both for 2D and 3D views).
- In a 3D view, clicking and dragging rotates the image. Clicking and dragging inside the blue circle (it appears when you click) rotates the objects in the direction you drag. Clicking and dragging outside the circle rotates in a twist direction.
- Click-dragging with the option/alt (⌘) key down pans the image.
- Option-scrolling (using the scroll-wheel, or track-pad) zooms the image (both for 2D and 3D views)
- Click-dragging on a 3D object with the command (⌘) key down will trace the cursor along the surface of the 3D object.

3D Ruler Tool

You can measure the distance between two points in the 2D view, or create complex paths along a 3D surface (e.g. skin) and view the length.

In the 2D view, clicking on the start point, then dragging while holding the mouse button down will create a straight line whose end-point will follow the mouse. You can then move the start and/or end points by click-dragging either one with the mouse.

In the 3D view, you can create straight or complex curves on any 3D surface (Fig. 9-8). Clicking between anchor

points will insert a point between them, while pressing the delete key will delete the currently selected (or last) anchor point.

3D Crop Box

This mode works in conjunction with a 3D object (e.g. skin) displayed in a 3D view. When invoked, you can click on a 3D surface to activate the box (Fig. 9-11). You then move the walls of the box in and out by click-dragging the spherical handles to set a clipping plane location. Letting go of the handle updates the clipping of the object according to the clipping box. Once done, turn the box off by selecting the smart cursor again.

Fig. 9-8

A: 3D ruler tool in straight-line mode: Shift-click-dragging along a surface creates a curved ruler along the surface. Note the curve appears as a straight line from above, but follows the surface when viewed from another angle. The length is displayed at the bottom of the view, and anchor points are automatically placed at 1cm intervals for reference.

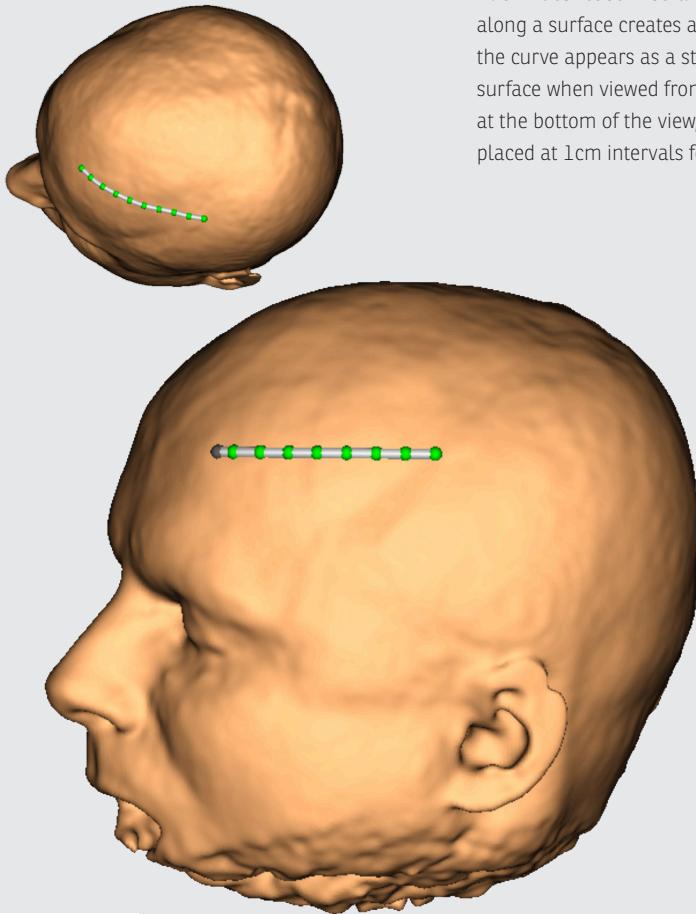

76.2 mm

Other functions:

- Pressing delete will delete the last, or currently selected anchor. If a middle anchor is deleted, the previous and next anchors will automatically be joined.
- Clicking between two anchors will create a new anchor between the other two.
- Click-dragging any anchor will move that anchor along the surface

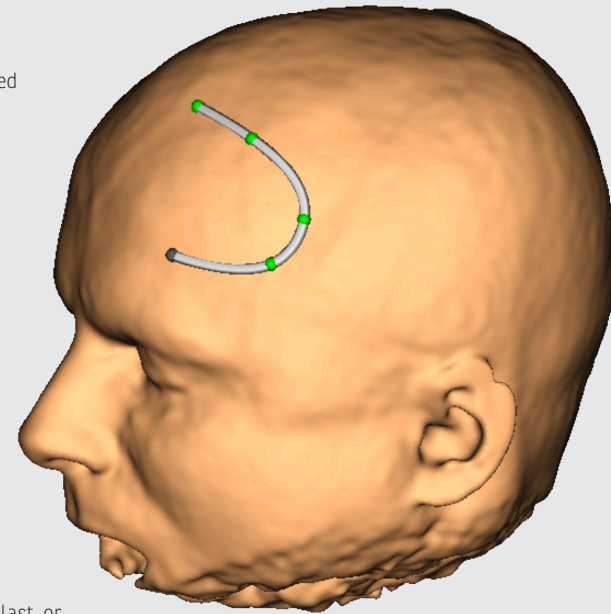

B: Spline mode:

Click on the surface to drop anchors at the location of each click to create complex curved splines. Each spline can be repositioned by click-dragging it.

Fig. 9-9

Custom View control window:

You can customize what is displayed in any 3D Image View using this window (accessed by selecting **customize...** in the view selector popup menu button):

3D Planes: Allows you to view the brain through one or multiple 3D planes.

Reconstructions: Allows you to select one or more 3D reconstructions generated from the 3D reconstruction step.

Accessories (in an Online Session): Allows you to add and track 3D representations of various objects, including the cursor, coil, trackers and the Polaris field of view.

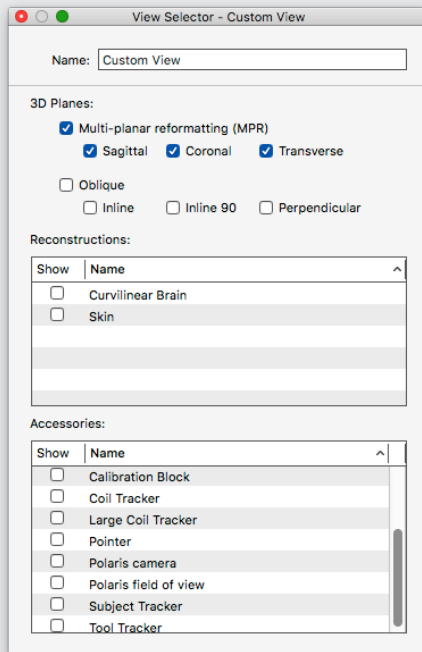
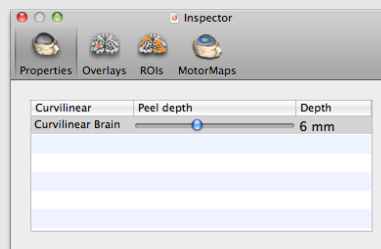

Fig. 9-10

Inspector tool:

When creating overlays, curvilinear surfaces, ROIs and motor maps, it is often convenient to change certain properties at different times. For example, you may wish to change the curvilinear peel while picking a target, or changing the overlay opacity. Rather than having to go back to the relevant steps to change these, the **inspector** button allows you to bring up a window that allows you to access and change many of these settings at any time, in any step. Clicking on the Inspector button (the blue circle with the "i" in the middle) calls up the inspector window.

A: Curvilinear surface inspector



B: Overlay inspector

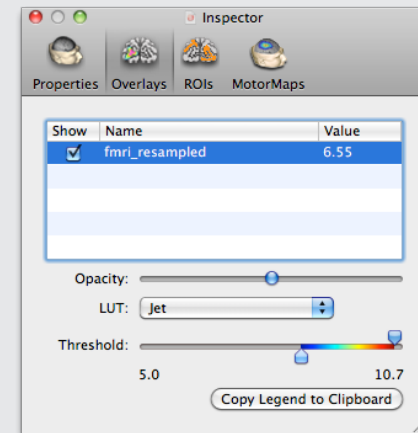

C: Region of Interest Inspector

(motor maps are described in Chapter 19)

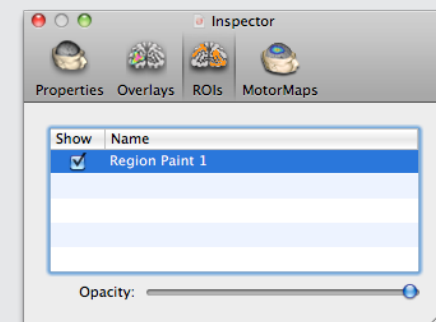

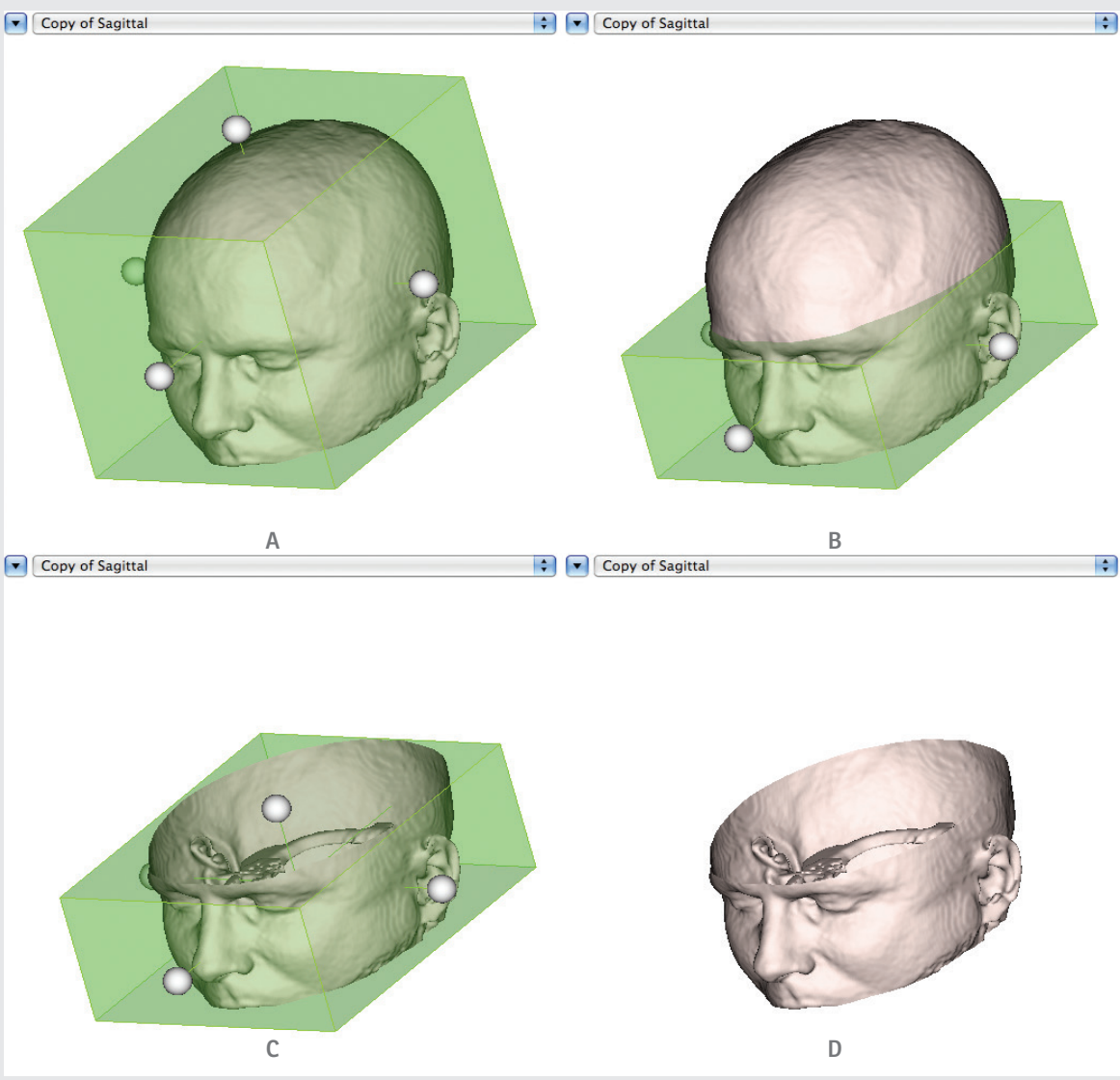

Fig. 9-11

Using the clipping box to clip an object (e.g. skin).

- A: Move the walls of the box by dragging the spherical handles (click-dragging).
- B: The upper wall was dragged down into the head.
- C: The head is cropped according to the bounding crop box.
- D: The crop tool is deactivated (be selecting the smart cursor tool) leaving the cropped object. Note that the box only applies to the object selected. Other objects inside the skin would remain whole unless another crop box is invoked and cropped.

Chapter 10: MNI/Talairach Registration

For many years, neuroscientists have used a common coordinate grid (often referred to as “stereotaxic space”) to localize their regions of interest (e.g. anatomical areas, or functional regions) so that data from multiple subjects could be combined or compared on a standard template. This is accomplished by mathematically aligning the coordinate grid of each brain using common anatomical references and using the brain’s size to scale the grid accordingly. The result is the ability to associate homologous anatomical regions of any brain to a common coordinate. The first stereotaxic coordinate system to gain mainstream acceptance was the Talairach and Tournoux atlas. They created an atlas from a single human brain specimen by cutting the brain into regularly spaced slices (and fixing them to slides), labelling the slices for various anatomical regions and superimposing a coordinate grid on them. Using coordinate space mapping techniques, any individual brain can be mapped to that common grid along with

any data recorded associated with that brain. More recently, an improved version of the Talairach brain, the MNI brain, was developed based on a model brain composed of an average of many individual brains mapped to that common space (instead of an individual brain). In many papers, it is common to report findings in “Talairach space” or “MNI space” to allow others to easily use these findings. The subtle differences between Talairach and MNI space is beyond the scope of this manual. Several reports exist in the literature that compare the two as well as the various methods that are commonly used to calculate these registrations (and how they are interrelated).

Brainsight provides tools to co-register your subject’s brain images to the MNI and Talairach coordinate spaces. This step is only required if you wish to use MNI or Talairach coordinates to define targets, or to export sampled coil coordinates in MNI or Talairach space.

Fig. 10-1

MNI/Talairach Atlas Registration Manager

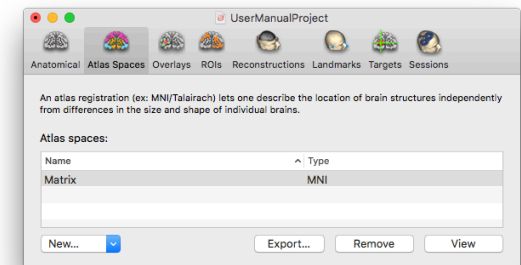

The relationship between the native MR images and Talairach space can be represented in many ways, depending on the type of transformation. Currently, Brainsight supports a linear transformation (translation, rotation and scaling), which can be represented by a single 4x4 matrix. You can either use a pre-existing transform from another program (e.g. MINC tools or SPM), or perform the procedure manually here. If you have a pre-existing transform, then it is advisable to use it here instead of the manual tool to maintain consistency between the coordinates obtained using your favourite analysis software and Brainsight. Use the Brainsight tools only if you do not already have a registration matrix derived from your preferred software.

Note: As updates to Brainsight are released, transformations from a wider variety of software programs will be

added. Please let us know which ones are important to you. It is important to understand the utility as well as to temper expectations of the overall accuracy of employing a linear transformation for the mapping. In practical terms, one should not expect better than a few mm in mapping accuracy.

You can perform more than one registration, and select or change which one to apply at any time. If you have already performed this step using another software application (e.g. SPM or MINC tools), then you can save time and maintain consistency by using that matrix as described in "Loading a pre-existing matrix", otherwise, perform the manual registration.



Fig. 10-2

Initial Manual MNI Registration Window.

MANUAL MNI REGISTRATION

In addition to supporting registration from SPM and MINC tools, Brainsight includes a manual registration tool. The manual registration tool will require you to perform a few steps to enable the software to calculate a linear transformation to map between the subject's native MRI to the reference Brain (MNI Brain). In the first step, you will identify two well established brain structures, the anterior and posterior commissure (AC & PC). This will

be used to rotate the brain image to align it along the AC-PC plane (correcting for tilt and twist rotations). The second step will be to tell the software the overall size of the brain by moving the walls of a box to the edges of the brain in the lateral, vertical and anterior-posterior (AP) directions. These distances are compared to the width of the reference brain to calculate the correct scaling

Fig. 10-3

MNI registration step with AC & PC identified.

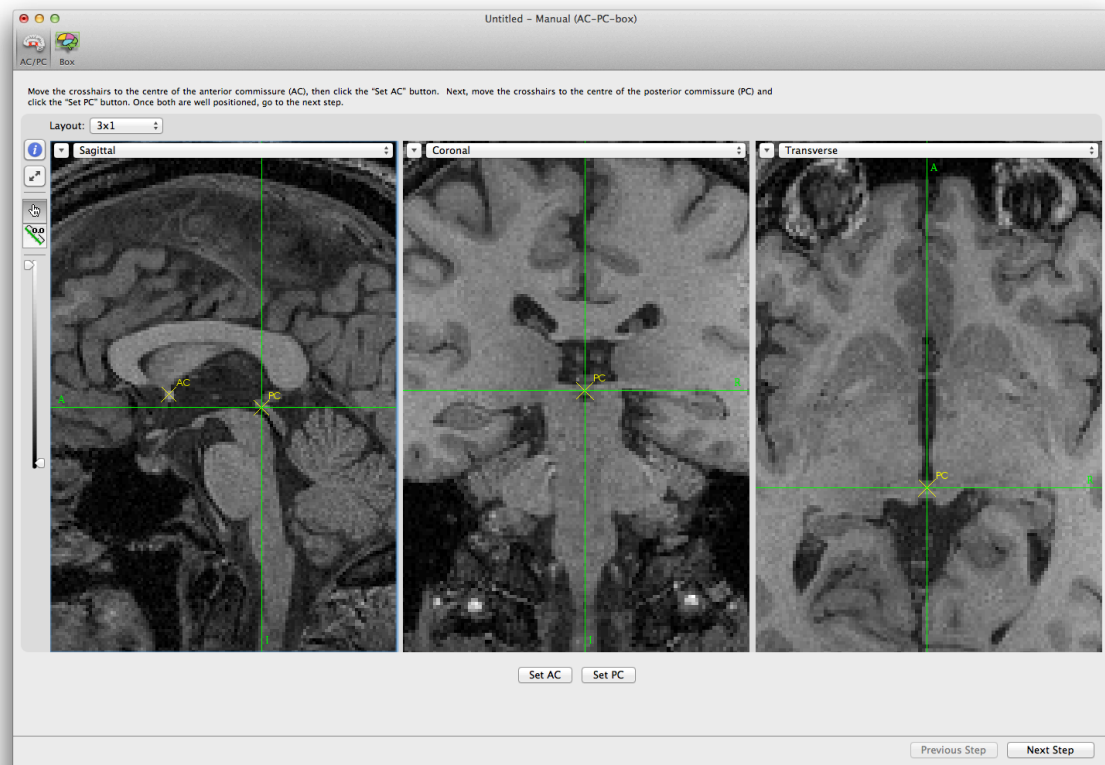

factors in the 3 directions. This information is enough to calculate a basic linear fit.

Select **Manual (AC-PC-scale)** from the New... popup menu, the MNI registration task manager will appear (Fig. 10-2).

- Move the cursor to the centre of the anterior commissure (AC) and click **Set AC**.
- Move the cursor to the centre of the posterior commissure (PC) and click on **Set PC**.
- Adjust either (if needed) by moving the cursor to the desired location and clicking either **Set AC** or **Set PC** again (Fig. 10-3).
- Click on **Next Step**.
- Correct for head tilt (if any) by moving the Alignment slider while observing the coronal image. Set the alignment so that the vertical green line follows the midline between hemispheres.
- Set the size of the bounding box to the outer limits of the brain on the AC-PC axis. Pay special attention to the coronal view for setting the left/right and superior/inferior limits and the transverse for the anterior/posterior limits (see Fig. 10-4). **Note that the sagittal view is not helpful because the outer perimeter of the brain is surrounded by the sagittal sinus. The sagittal image should be ignored.**
- Click **Update**. In a moment, the registration will be calculated and the ICBM 152 average brain will be warped and overlaid on the MR images. To visually

examine the quality of the fit:

- Drag the lower threshold control to the right a bit to remove the background colour and better see the outer perimeter of the model brain (displayed using the JET colour scale).
- Change the opacity back and forth repeatedly to better evaluate the fit. By swinging the opacity back and forth, you can flip between the original brain and the reference brain and gain an appreciation of the fit.

- You can interactively adjust the bounding box and click Update to adjust the fit until a reasonable fit is obtained.
- Click **Finish** to complete the task.

Note: The registration procedure is meant to calculate the native to MNI space calculation. Both the MNI and

Fig. 10-4

MNI registration step with set brain boundaries. Focus your attention on the upper, lower and lateral bounds of the coronal slice, and the anterior and posterior bounds of the transverse slice.



Talairach coordinates can be used.

LOADING A PRE-EXISTING MATRIX

If you have the file containing the registration matrix (MINC tools), choose **From .xfrm...** from the **New** popup menu button, and select the file, otherwise choose **From Matrix**. Note that a window displaying anatomical images with the ICBM 152 average brain (warped using the loaded matrix) will appear (Fig. 10-5). The actual matrix is also displayed on the top left of the window.

Every transform matrix represents a transformation from one coordinate system to another. The matrix entered either by loading an xfm file or entering the matrix manually must be from the "World" space coordinate system as defined by your anatomical images (e.g. scanner coordinates), to the MNI space. For example, when using SPM, the .mat file does not work because it is from voxel space (whose definition changed over the years) to MNI space, while the PDF report works because it describes the world space to MNI space transform.

If the overlay does not match the anatomical data (particularly if it does not agree with how it looked in your other software), then you may need to manipulate the matrix. Currently, you can invert and/or transpose the matrix (by clicking the Invert or Transpose buttons) or edit the matrix manually by typing in the numbers directly.

A NOTE ABOUT MNI AND TALAIRACH SPACE

When using "normalized" space coordinates, it can be very easy to get confused. In the "old days", Talairach was the coordinate space used. More recently, a modernized version of the normalized space was developed by the International Consortium of Brain Mapping (ICBM) to try to develop a brain more representative of the overall population (Talairach was based on a single individual brain). This group developed the "MNI" brain, which was created by co-registering multiple brains (imaged using MRI) into a common Talairach-like space.

In Brainsight, the entered registration, be it by matrix or performed manually is assumed to be to the MNI space. We have implemented the formula proposed by

Lancaster, Fox et. al. (Lancaster et. al., "Bias Between MNI and Talairach Coordinates Analyzed Using the ICBM-152 Brain Template", Human Brain Mapping 28:1194-1205 (2007) to convert from MNI to Talairach space for compatibility reasons.

EXPORTING THE MNI REGISTRATION MATRIX

In certain cases, you may wish to export the MNI registration created in the step for comparison with other methods or for use in other programs (to maintain consistency). To export the matrix into an ".xfrm" format file (a simple text file used in MINC tools and easily converted to other formats), click **Export...** in the Project window (Fig. 10-1) navigate to the desired folder, enter a file name and click **Save**.

Fig. 10-5
Verification screen for MNI registration. Registration matrix is shown at the top left.

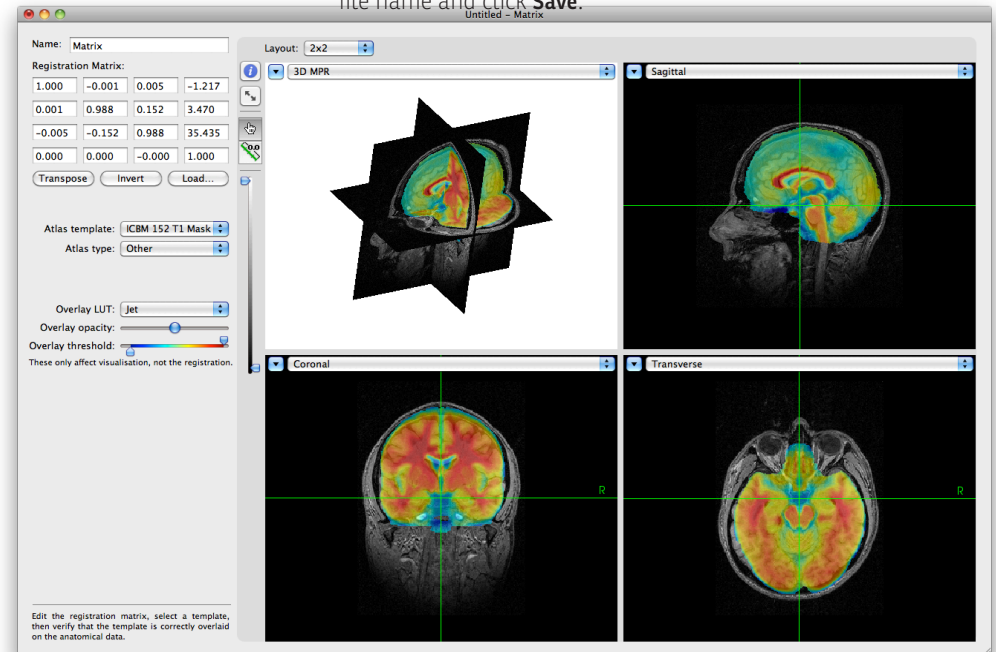

Chapter 11: Image Overlays

In addition to using MNI or Talairach coordinates, you can load functional or other anatomical data, (e.g. a T2 MRI) to overlay them on the anatomical MRI. You can also overlay an Atlas and warp it from its MNI reference space to the native shape of the subject.

Fig. 11-1

Overlay manager.

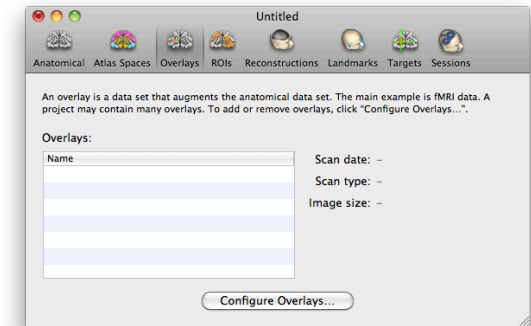

Click on **Configure Overlays...** to add or edit overlays.

ADDING FUNCTIONAL OR ANATOMICAL OVERLAYS

Overlays are simply volumetric data sets that have some intrinsic meaning to you. In the case of functional or anatomical data, the data should be in the native space of the subject.

- To add a new overlay, click **Add...** Select the image file (using the same rules for the different file formats as was applied for the anatomical image data as described in Chapter 9).
- The file needs to have been co-registered using another software program (and either re-sampled, or the registration matrix exported to be entered here). Select the registration method used:
 - If the data set was re-sampled to match the

Fig. 11-2

Overlay window

anatomical, select **"none"** as the registration.

- If the method stored the registration to the anatomical images in the header (as is sometimes done with MINC and NIFTI), select **"from headers"**.
- If a matrix is used, select **"Matrix..."** and enter the matrix manually, or by loading a supported matrix file format (MINC .xnm, SPM12 .mat and plaintext files with 16 numbers, each separated by a whitespace character). When entering a manual matrix, take special care to ensure that the matrix is correct by observing the orientation and fit of the overlay on the anatomical images.
- For BrainVoyager images, select the .vmp (versions 1-6) file which has been co-registered to the anatomical images, and select **"from header"** as the registration. As with BrainVoyager anatomical images, use the AC-PC aligned (but not scaled to MNI space) images.
- For an atlas file, use **From current MNI registration** (see next section).
- Set the threshold of the images. The checkboxes at either end of the Threshold slider allow you to either show or hide the data beyond your set threshold. If shown, data that is either above or below your threshold level (depending which checkbox is unchecked) will be shown as a solid colour from the extreme ends of your LUT (e.g. blue would represent all data below the chosen threshold, and red would be displayed for all data above a chosen threshold).

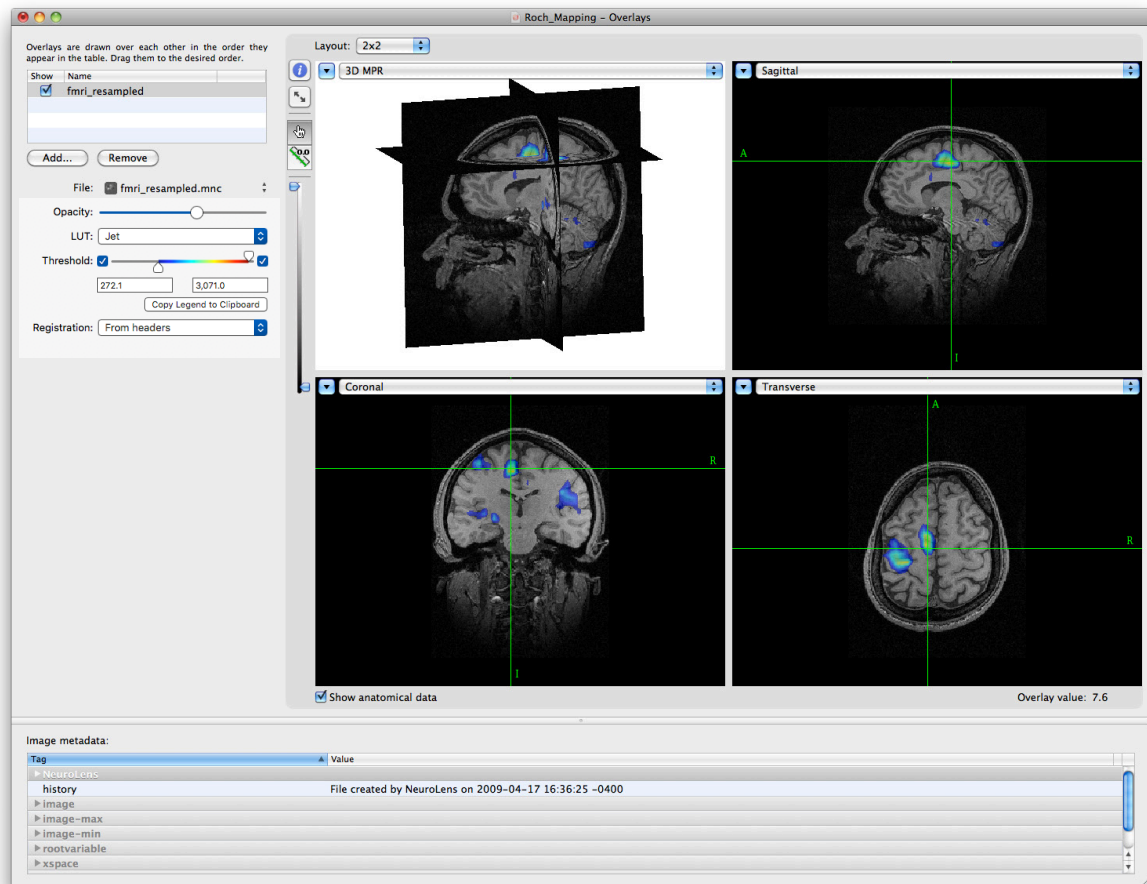

Note that Brainsight does not support showing both positive and negative changes in response at the same time (yet). You can work around this limitation by loading the overlay twice and setting the thresholds to display the positive on one, and the negative on the other.

- Select the desired lookup table (LUT) using the **LUT** popup menu button.
- Set the desired opacity of the overlay using the opacity slider.
- The overlay value (if the overlay selected in the list) at the cursor location is displayed at the bottom right of the window.

You can load multiple overlays, and select which ones you want to be visible by default by enabling/disabling the visible checkbox next to each entry. You can also change the order of overlays by dragging the images in the list around to set the desired order. When finished, close the overlay window by clicking on the close button at the top left of the window.

LOADING AN MNI ATLAS FOR OVERLAY

You can load and overlay an Atlas however there are a few requirements:

- You need to perform an MNI registration (see Chapter 10) so the software knows how to transform space to/from MNI space.
- The Atlas file needs to have defined the transforma-

tion from the image voxels (voxel space) to the MNI space, stored either in the header or as a separate transformation file. Atlases in MINC format usually have this embedded so they should work. Other formats (e.g. NIFTI) will need to be validated first.

- In this version of Brainsight 2, the atlas must have 256 indexed regions or less. This will be improved upon in a future release.

To load an atlas as an overlay:

- Click **Add...** and select the atlas file using the file selection dialog that is shown.
- Once loaded, select “Atlas” as the LUT (it is an indexed colour table to maximize the contrast between adjacent atlas regions).
- Select “**Using atlas space**” as the registration method.

Fig. 11-3

Overlay window with atlas

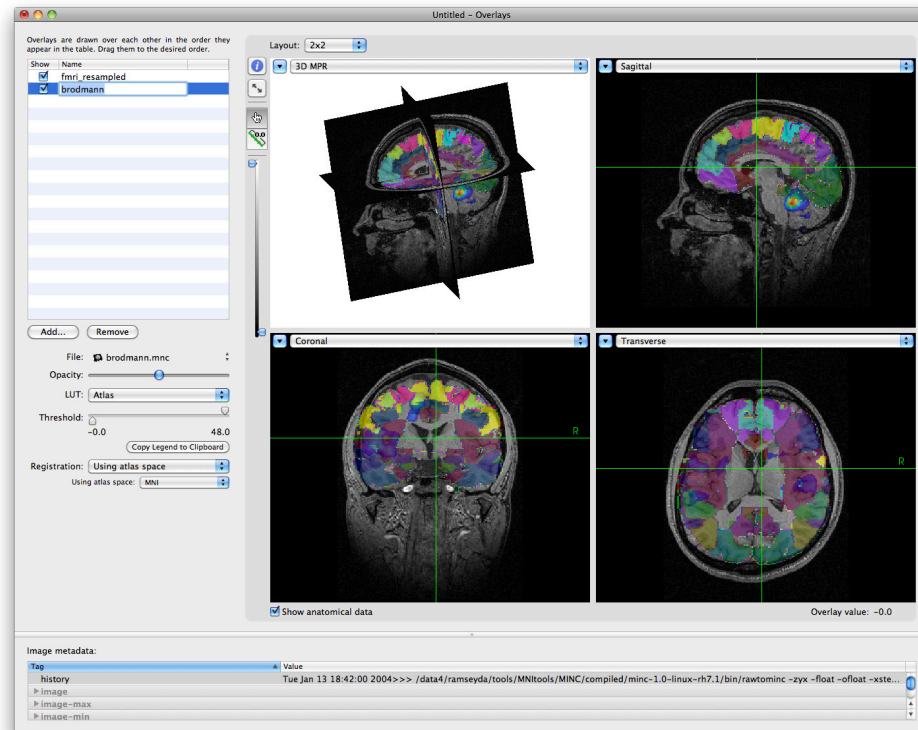

This is disabled if you did not perform an MNI registration. If you performed more than one atlas registration, select it from the popup menu under the registration method popup menu.

- Select MNI or Talairach to identify the base coordinate system for the atlas.
- Verify that the Atlas overlays correctly on the anatomical images. Note that Talairach atlases may have a poorer registration quality as it undergoes an additional transformation from Talairach to MNI space before being transformed from MNI to the subject's native space.

Chapter 12: Region of Interest (ROI) Painting

INTRODUCTION

In most 3D reconstruction techniques involving MR and CT images, voxels in the images are first labelled (segmented) and grouped so a suitable method of calculating a 3D surface to represent the shape of the boundary of the labelled voxels can be used. There are other examples of the utility of labelling a region of voxels including algorithms that use labelled regions of interest (ROIs) for resting state fMRI analysis or generating diffusion maps.

Brainsight implements a basic ROI tool that allows you to manually label, or paint, voxels on the 2D slices to create regions of interest. Once the region has been painted, it can be treated as any overlay and displayed in any of the planes. It can also be exported as a NIfTI file for use in other analysis and display software.

Region painting refers to the process of segmenting the region you are interested in (e.g. the skull, or a particular brain structure) from the surrounding data by labelling it (e.g. painting image voxels) as illustrated in Fig. 12-1A. 3D reconstruction methods, described in Chapter 10, can take this labelled data and create a 3D surface (3D mesh) to be displayed and manipulated as a discrete object (Fig. 12-1B).

Fig. 12-1

A: Example of a painted Region of Interest (ROI).

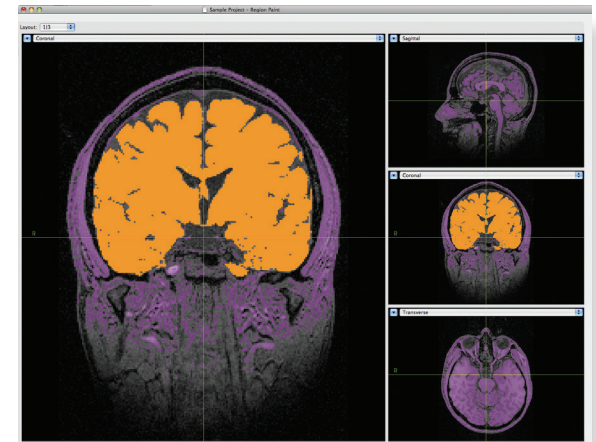

B: Example of a 3D surface representation of the edge of the ROI using the "Surface from ROI" described in the next chapter.

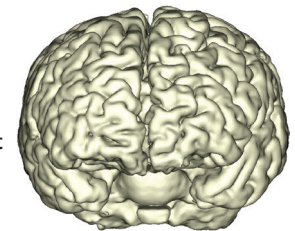

Brainsight currently supports region growing (we call it a threshold/seed operation) and manual painting to create and edit ROIs. The threshold/seed tool is useful if your structure of interest contains a distinct region that can be isolated by selecting an intensity range. Think of the seed tool as a persistent flood fill (often called a paint bucket) tool, which spreads "paint" to all connected voxels that fall within the threshold intensity range. You typically set an intensity range for your structure then drop a seed in the structure. The seed will initiate a fill operation (region growing) at the seed location. You then go to the next slice, and the seed will follow you to that slice, and initiate a fill again. The seed is smart enough to search a small area for the threshold if it lands on a new slice outside of the threshold area (this can happen if the shape of the structure changes from slice to slice).

The manual painting tools can be used to delineate areas that are not strictly intensity based, or where the seed/threshold either missed a spot, or filled into an unwanted area (despite being within the threshold bounds). For example, the skin reconstruction can usually be performed automatically because there is a large difference in intensity between the skin and surrounding air. The brain can also be isolated (mostly) except in regions where there might be structures with similar intensity ranges that exit the brain cavity into other areas (e.g. optic nerves). In these cases, you would let the seed(s) apply to the slice, and use the paint/erase tools to edit the results to conform to the structures.

CREATING AN ROI

This section will cover creating an ROI and explain the use of the tools as they are needed. To create an ROI, select the ROIs tab at the top of the project window then click **New ROI->Empty**. The region paint window will appear (Fig. 12-3). The window will have a layout with 4 image view panes. The larger view is the painting view, while the other 3 are for location reference. Clicking in the 3 smaller views will move the cursor. Clicking in the paint view will perform an operation that depends on the currently active tool.

If your structure can be isolated by a range of image intensities, then:

1. Set the orientation in which to paint by selecting it from the orientation popup menu of the painting view. You can change orientations anytime and continue painting in the other slice (although that can get confusing).
2. Optionally, click on **Smooth data set** to apply a 5mm Gaussian smoothing kernel to paint from a smoothed version of the data. This will reduce sharp edges and noise, but will also blur out small structures.
3. Use the threshold sliders to set a range of intensities that help isolate your structure of interest. The voxels that fall within the upper and lower threshold bounds are referred to as the isolated voxels, and are displayed in purple (you can change that colour by

Fig. 12-2

ROI manager. Note that the volume is shown for each ROI.

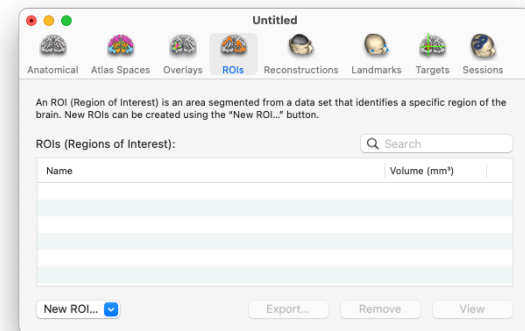

clicking on the colour indicator box and selecting a new colour using the colour picker, and the opacity using the opacity slider). See Fig. 12-3.

4. Select **Seed** (among the painting tools as shown in Fig. 12-5) and click in the region of interest. The result will look like Fig. 12-4 B.
5. If the structure of interest consists of multiple disconnected regions that are isolated using the threshold values, add seeds to those regions by clicking in them.
6. If a region that is not isolated by the threshold values exists, you can use the Pencil and Fill Region tools to include it manually. Select **Pencil**, and draw the border of the region (Fig. 12-4 C). Select **Fill Region** and click in the middle of the region to fill the region (Fig. 12-4 D). Note that you can avoid clicking back and forth between the Pencil and Fill tools by remaining in the Pencil tool, and flood fill by option-clicking where you want to fill.
7. To exclude a region that was mistakenly included, select **Eraser**, and use it to delineate the unwanted part from the rest of the painted region, then use the Erase Region tool to clear the region by clicking on the isolated paint region. Note that as with the Pencil and Fill tools, you can remain in the Eraser tool, and option-click the region to apply the Erase Region to it.
8. Once the region has been painted, proceed to the

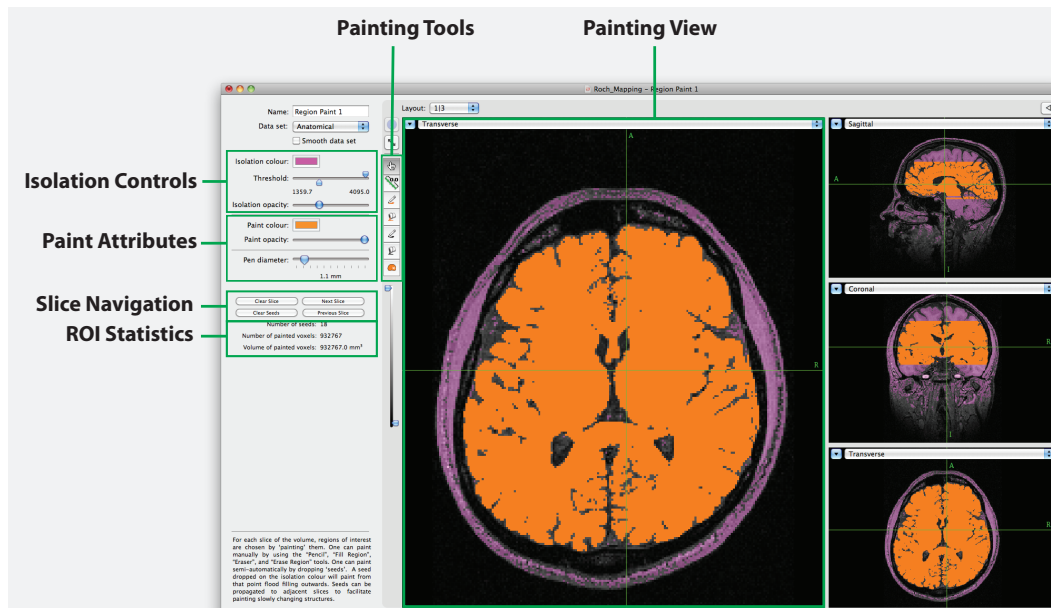
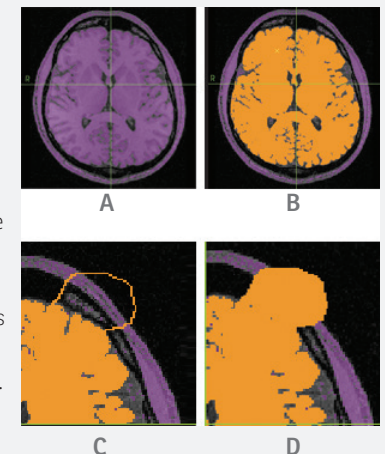

Fig. 12-3

Region paint tool. The area in purple is referred to as the isolated region. It represents the voxels in the displayed slice that fall within the threshold range set using the threshold sliders which are part of the isolation controls. The painted region is shown in orange (in this example) and is generated by a seed being dropped in a thresholded region.

Fig. 12-4

Region painting Tool, using seed/threshold and line pencil/fill region methods. eraser/erase region work the same way as the pencil and fill region tools except they erase painted voxels. Note that the fill and erase region tools use the painted voxels to define the boundaries, NOT the thresholded voxels.



next slice by clicking **Next Slice** or **Previous Slice**.

9. Notice that any seed in the last slice is propagated to the new current slice and applied to paint the slice. Add seeds as needed and manually add/remove painted regions as in the previous steps.
10. If you find that after several slices that you have too many seeds (e.g. disconnected structures in previous slices are now joined, or the seeds have migrated to unwanted regions), click Remove All Seeds to clear the seeds, and then click Clear Slice to erase all paint in the slice and start fresh.
11. Once you have painted the entire region, close the window. This is probably a good time to save your project.

Note that during this process, you will almost certainly click on something you did not want to, losing the work you just did. To Undo the last operation, simply select **Edit->Undo (Cmd-Z)**.

IMPORTING AN ROI

If a labeled volume has been created in an external program (or exported from Brainsight as part of another project), you can import the data from a file. Click **New...->From File...** and select the file. A dialog will appear (Fig. 12-6) to select what data set to display under the ROI (typically the anatomical data) and if needed, select the min and max thresholds to map that range to the ROI bitmap. Recall that unlike overlays, ROIs are single value bitmaps so any data set that has more than one

Fig. 12-5

Close-up of ROI tool listings.

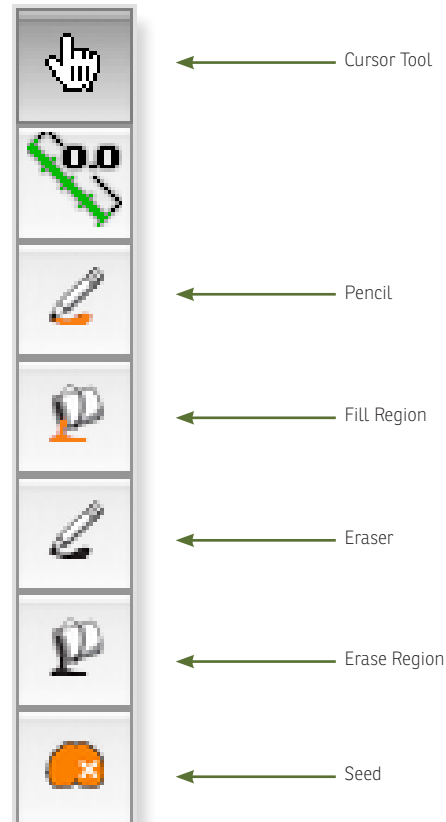

Conceptually, the Pencil/Eraser and Fill Region/ Erase Region tools are opposites of each other. The Pencil and Fill Region tools label voxels while the Eraser and Erase Region tools clear voxels.

value needs to be mapped to the single value using the threshold. Any values between the min and max values will be mapped as a 1 value, and voxel whose value falls outside the threshold window will be mapped to 0.

EXPORTING AN ROI

Once you have created an ROI, you may find it useful to export it into a volumetric image file for use in other applications. For example, you might find the drawing tools to be useful in generating regions of interest for ROI-based analysis (e.g. for probabilistic tractography). Once the ROI is complete, click **Export...** Once the save file dialog appears, navigate to the desired folder, enter a file name (the name of the ROI is used as a default name) and click **Save**. The file will be saved as a NIFTI (.nii) file. using the anatomical data set as the template for the voxel size and image orientation.

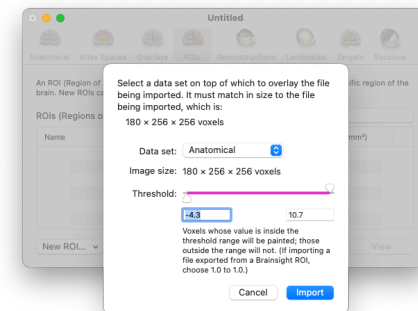

Fig. 12-6

ROI import screen.

Chapter 13: 3D Reconstruction

3D reconstruction is the operation of creating a 3D surface for the purposes of display to aid navigation. These 3D objects can be painted with a solid colour or texture consisting of the image voxels intersecting the surface (see curvilinear reconstruction). Brainsight currently supports several reconstruction methods: the automatic skin, automatic curvilinear, and reconstructions derived from overlay data sets and ROIs. 3D surfaces generated from 3rd party software can also be imported and visualized.

Fig. 13-1

3D reconstruction manager.

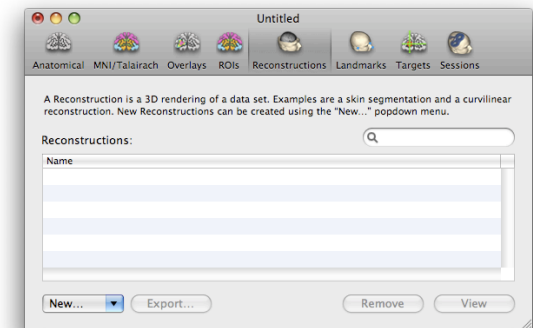

3D reconstructions are performed for many purposes. First, a skin reconstruction is performed to simplify the identification of anatomical landmarks for the subject-image registration (Chapter 16). Second, a 3D brain reconstruction is performed to simplify target selection and provide a more intuitive view of the brain (and scalp) while placing the coil during a NIBS session. Finally, 3D reconstructions of regions of interests or ROIs can help visualize relevant functional activations or specific anatomical structures relevant to your particular protocol.

PERFORMING A SKIN RECONSTRUCTION

- From the reconstruction manager pane of the project

window (Fig. 13-1), click on **New...** and select **Skin**. An image view window will open.

- If desired, set the bounding box to encompass the whole head by dragging the boundaries with the mouse. Any surface will be cropped to this bounding box. Note you can also use the 3D crop tool to crop the surface interactively in any image view at any time in any step within Brainsight, when desired as opposed to this crop, which can only be changed by returning to this step and repeating the reconstruction with a different crop box setting. You might leave part of the bottom out here to have a “clean cut” bottom if the intensity of the MR image drops off. Otherwise, the head may look “ghoulish”, although this is an aesthetic recommendation (see Fig. 13-2).
- If the MR data is noisy, you might notice that the skin reconstruction includes several small “floating bits” where clumps of noisy voxels were converted to small 3D objects. Enable **Keep only largest piece** and repeat the reconstruction to automatically remove all the unwanted small objects.
- Set the colour to your desired setting by clicking on the colour box, and selecting the colour using the palette that appears.
- If needed, adjust the threshold to isolate the head vs. the surrounding air (and MR noise) as much as possible.
- Click Compute Skin. The skin object will appear in

Fig. 13-2

Skin segmentation step with head properly cropped.

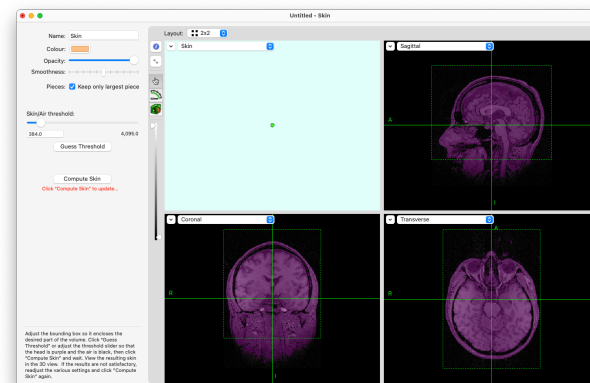
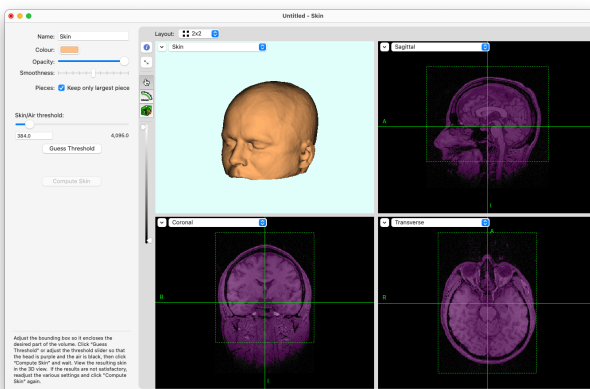

Fig. 13-3

Completed skin.



the top left view shortly (Fig. 13-3).

- If the results are not satisfactory, adjust the threshold and recompute the skin again.
- Once the desired skin has been created, close the window by clicking the close button (top left button)

CREATING A CURVILINEAR RECONSTRUCTION OF THE FULL BRAIN

Many software programs represent a 3D brain as a surface mesh much in the same way we generate the 3D skin (see Fig. 12-1). While this often provides a good representation of the brain surface, it has drawbacks in the context of TMS. First, TMS does not only stimulate the brain surface, but potentially the entire thickness (approximately) of the cortical ribbon. Second, if you want to use fMRI peaks as targets, it is important to be able to visualize the location within the brain where the activation was recorded (many surface based models project the fMRI data to the cortical surface, effectively moving the target).

The curvilinear reconstruction is designed to provide you with a 3D representation of the entire cortical ribbon, by creating a representation that can be interactively peeled to different depths, much like peeling the layers of an onion.

To create a curvilinear reconstruction:

- Click **New...** and select **Full Brain Curvilinear**.
- The default settings are typical values which are a

stop depth of 16mm with a slice spacing of 2mm. You can change these values to your preference. Simply enter your desired end depth and spacing. The start is assumed to be 0mm.

- Click **Compute Curvilinear** to generate the curvilinear surface. The process can take up to one minute depending on your computer.
- Once the brain has been generated, rotate it to examine the brain surface, and use the peel slider to peel the surface to different depths.
- Close the window by clicking on the close button at the top left of the window.

Fig. 13-4
Curvilinear surface "peeled" to reveal fMRI peak.

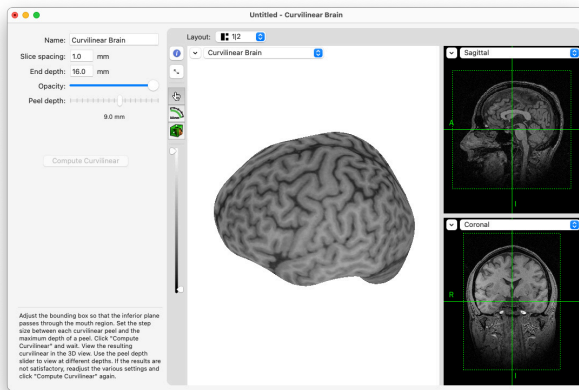

IF THE RECONSTRUCTION DOES NOT WORK:

The automatic curvilinear reconstruction is designed to work without requiring any user input. Occasionally though, the algorithm will fail. Without going deep into the implementation of the algorithms, one of the causes of failure is an error in determining the approximate

Fig. 13-5

Adjusting the crop box to help the automatic curvilinear algorithm

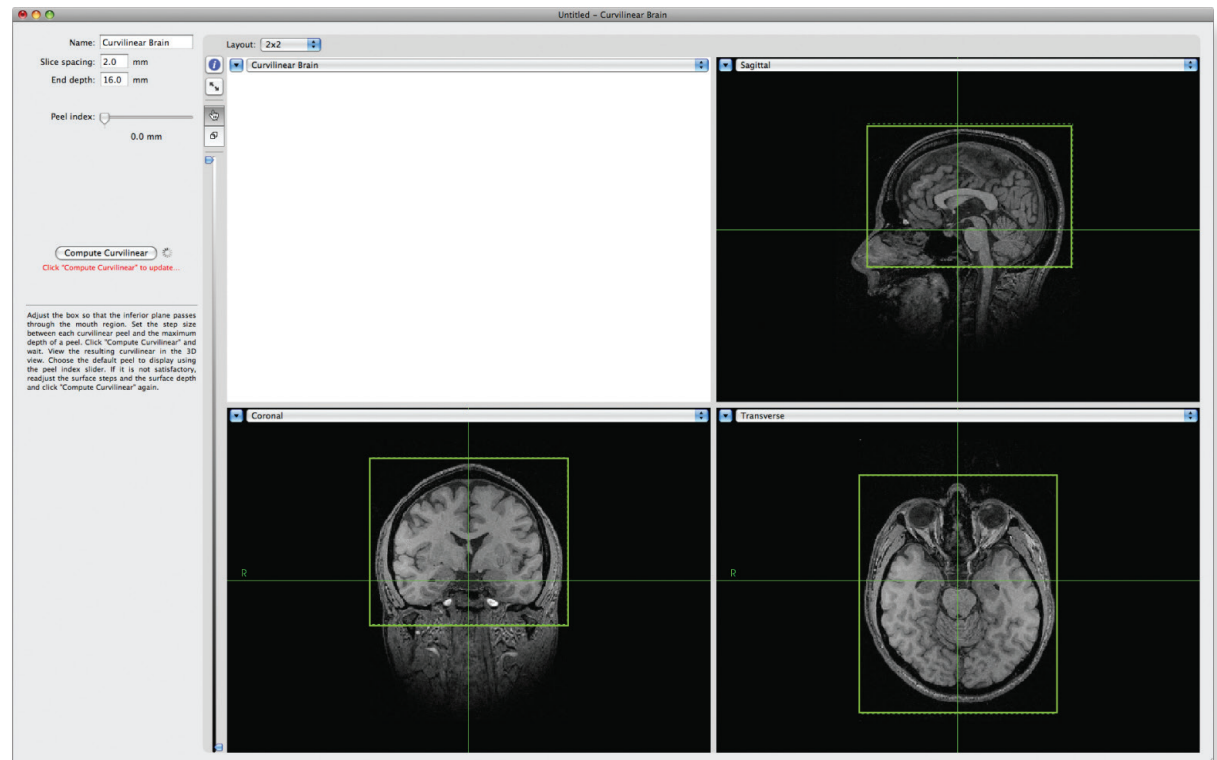

centre of the brain (which is the starting point for the algorithm). This can be corrected by adjusting the bounding box to delineate the brain from the rest of the head. This is particularly helpful in cases where the image acquisition is in the sagittal plane with large field of views (so there is a lot of neck in the field of view). To adjust the starting point:

- Move the edges of the box until the brain is delineated (Fig. 13-5).

- Click Compute Surface again and view the results.
- If this does not help, use a workaround procedure described in the next section.

CREATING A CURVILINEAR BRAIN RECONSTRUCTION USING A MODEL SHAPE

In certain cases, particularly when using the model brain or individual MR images of subjects whose scans contain artifact or lesions, the automatic curvilinear reconstruction may fail. In these cases, there is an alternate method to obtain a good curvilinear reconstruction. Consider how the curvilinear reconstruction works. The first step in the automatic algorithm is to attempt to generate a 3D shape of the brain by finding the brain boundary and generating a 3D mesh (and generating the concentric slices as additional meshes). The second phase is to “paint” the surface of this mesh with the values of the MRI voxels that touch the mesh. The failure in the curvilinear reconstruction is a failure in the first phase. Instead of attempting to interpret the subject’s MRI to determine the shape, the MNI model head can be used as a reasonable substitute for the shape. By performing an MNI registration, the model head can be loaded as an overlay and warped to “match” the shape of the subject’s brain. That adjusted shape can be used to generate the 3D mesh for the curvilinear, then the original voxels can be used to paint this surface.

The workaround procedure is as follows:

- If the anatomical data set is a subject-specific MRI,

then perform an MNI atlas registration to calculate the subject-MNI transformation (see Chapter 10). If the anatomical is the model head (see “Opening a Previously Saved Project” in Chapter 9), skip this step.

- Select the overlay step (Chapter 11). Load an MNI model head as an overlay. An appropriate overlay image file can be found in the Sample Data folder that came with your Brainsight computer, or on your Brainsight software USB key. Locate the file “icbm_avg_152_t1_ta_lin_masked.mnc” and load it.
- If the anatomical MRI is subject-specific, then select **Using atlas space** as the Registration method (by selecting it in the popup menu button) and MNI Atlas as the subtype. If the anatomical data set is the model head, select **From headers** as the registration method. Close the overlay window.
- Select **New->Curvilinear from overlay**, which will open the curvilinear creator window (Fig. 13-6). Select the MNI overlay as the overlay dataset (it is the default if you only have the one overlay). Set the lower threshold to a value above 0 to highlight the brain.
- Set the slice spacing and end depth to your preferred values and Click **Compute curvilinear** to create the surface.
- Note that while the shape appears reasonable, the

resulting surface as displayed in this window uses the model head voxels (and the threshold overlay) for the display. This is normal. When the same curvilinear is used in any other window (e.g. targets and perform), the original anatomical voxels will be used.

CREATING A CURVILINEAR SURFACE FROM AN ROI (FOR SMALLER STRUCTURES)

In most cases, the automatic curvilinear surface will meet your needs. In some cases however, it may be desirable to perform a curvilinear reconstruction of a more localized region of the brain (e.g. cerebellum) or of the whole brain, if the automatic curvilinear reconstruction failed. In these cases, you can create a curvilinear reconstruction based on a region of interest. For example, you can use the region of interest tool to paint the cerebellum.

To create a curvilinear surface based on an ROI:

- Use the ROI tool to segment your structure (see Chapter 12).
- Click **New...** and select **Curvilinear from ROI**.
- Select the ROI from which you want to generate the 3D surface (if you have multiple ROIs) and set the step size and end depth. For smaller structures, a step size of 1mm and an end depth of 10mm might be more appropriate than the default values.
- Click **Compute Curvilinear**, wait for the process to complete, and view the results in the 3D view.

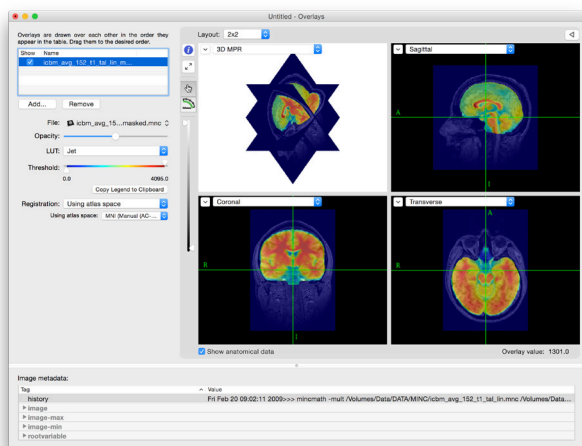

Fig. 13-6

Curvilinear reconstruction using a model head for the shape.

A: Overlay step:

Load the model brain as an overlay and use an atlas registration to warp it to match the shape of the subject brain.

B: Create the curvilinear from overlay.

Note the voxels from the overlay are used to paint the surface in this step, but in subsequent steps (e.g. targeting), the anatomical image's voxels are used.

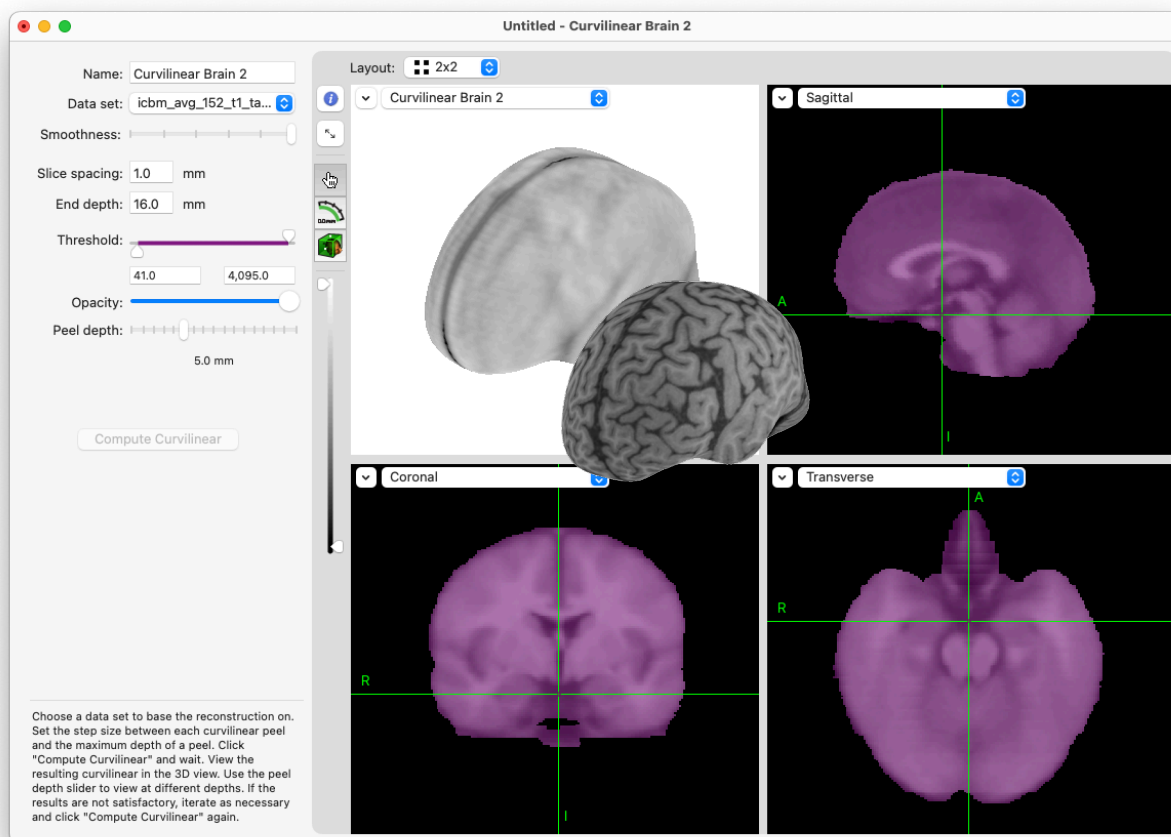

- If the surface appears too spherical (see left of Fig. 13-7), then the smoothing setting was likely too high. Lower it by dragging the smoothness slider to the left a couple of notches, then click **Compute Curvilinear**. After a moment, the change will appear in the 3D view.
- If the surface was too rough (middle of Fig. 13-7) then increase the smoothing by a notch or two by moving the smoothness slider to the right and click **Compute Curvilinear** again.
- The expected result is shown on the right of Fig. 13-7.

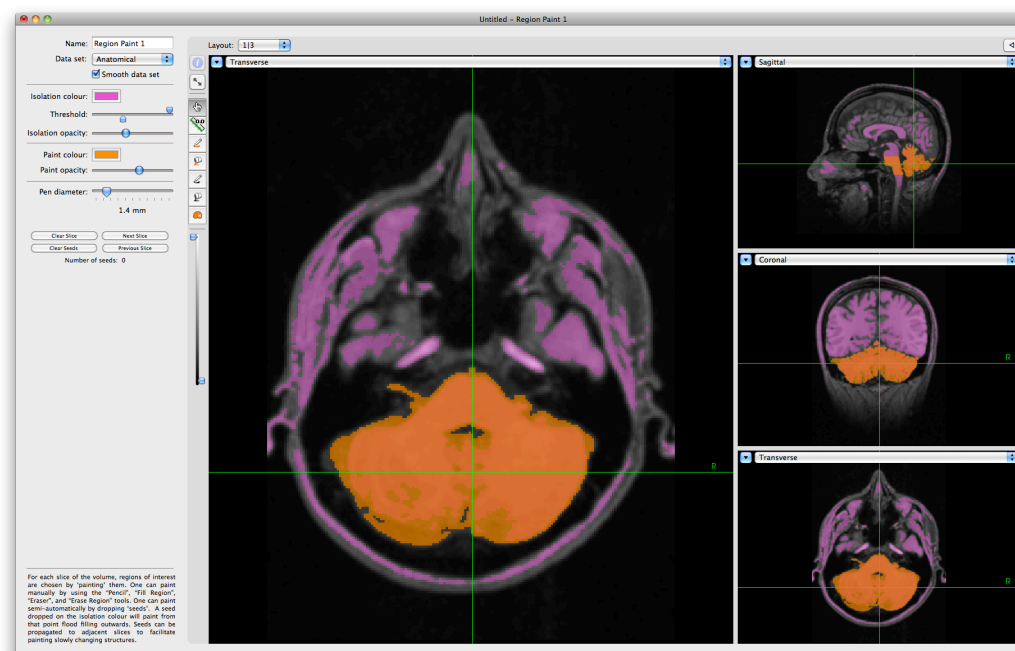
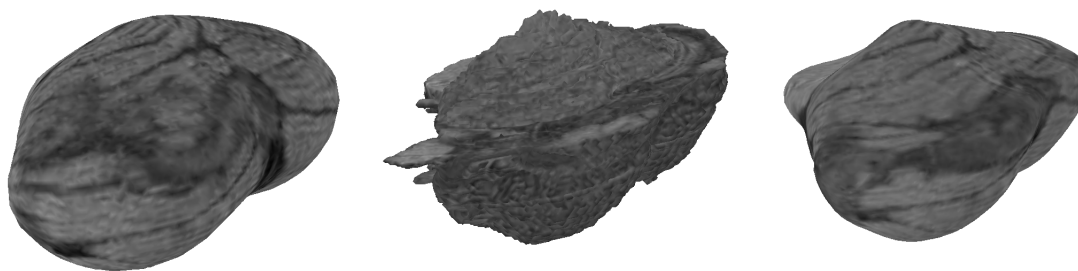

Fig. 13-7

ROI of a the Cerebellum (top) and the curvilinear surfaces derived from it (below) using various smoothness values.



CREATING A 3D SURFACE FROM AN OVERLAY

To create a 3D representation based on an overlay data set:

- Click **New...**, then select **Surface from Overlay** to open the surface creation window.
- Select the overlay to generate the 3D surface from (if you have multiple overlays).
- Set the lower and upper thresholds to the desired value to delineate the desired intensity range.
- Click **Compute Surface**, wait for the process to complete, and view the results in the 3D view.
- Verify that the surface is acceptable. Change the threshold or smoothness parameter if needed and click **Compute Surface** to update it.

If you cannot isolate your structure solely using an intensity

range, cancel this process by closing the window (do not save the surface) and use the ROI tool to delineate your structure and see the next section on creating a surface from ROI.

CREATING A 3D SURFACE FROM AN ROI

Creating a surface from an ROI is simpler than creating a surface from overlay.

- Click **New...** and select **Surface from ROI** to open the surface creation window.
- Select the ROI to generate the 3D surface from (if you have multiple ROIs).
- Click **Compute Surface**, wait for the process to complete, and view the results in the 3D view.
- Verify that the surface is acceptable. Change the smoothness parameter if needed and click **Compute Surface** to update it.
- If the overlay is noisy and you obtain a lot of small objects and only expect (want) the largest one, enable **Keep only largest piece** and click compute again.
- The colour can be selected by clicking the colour button and then the colour from the resulting colour picker window. Enabling **Blend in overlays** will have any overlays turned on be painted on the surface.

IMPORTING 3D SURFACES FROM OTHER SOFTWARE

Brainsight can import surfaces saved in AutoCad™ (.dxf),

Fig. 13-8

Screenshot of the surface from overlay function.

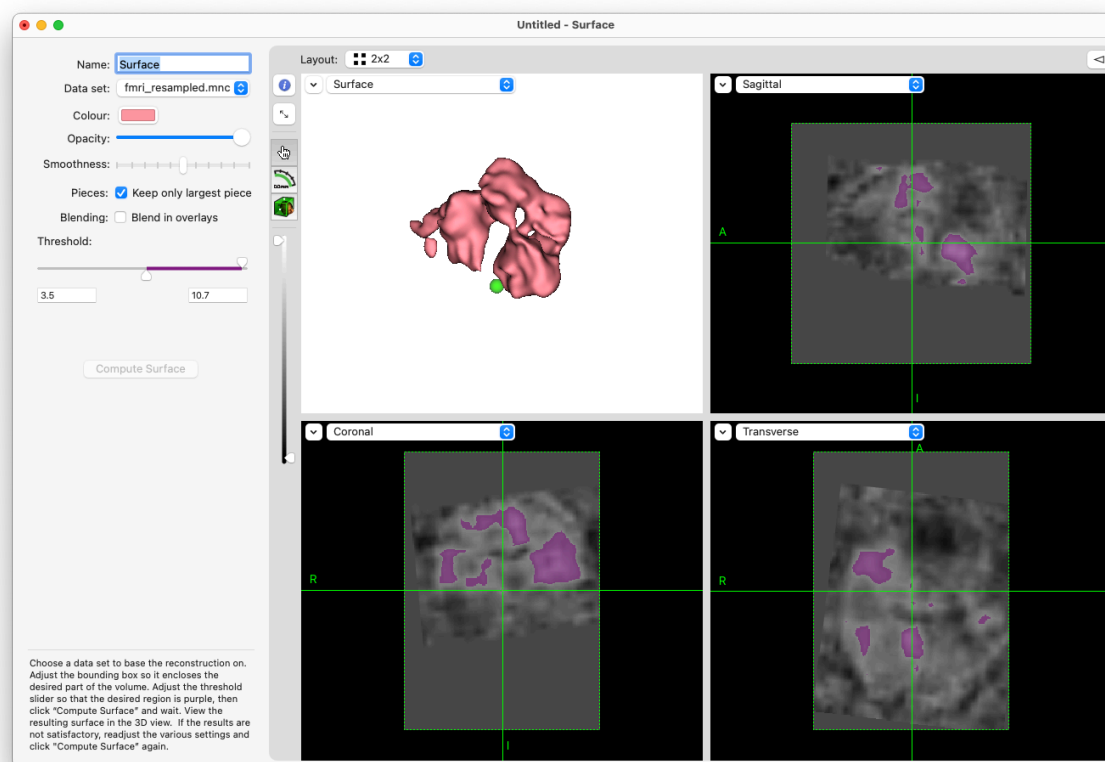

polygon (.ply), VTK (.vtk) and stereolithography (.stl) formats. It is important that the coordinate system of the mesh be in one of the coordinate systems understood by Brainsight, (Brainsight, World and optionally MNI) and selected in the file dialog when importing. Otherwise, the location of the objects will be incorrect.

To import a surface:

- Click **New...** and select **Import from File...**
- Select your surface file from the file selection dialog and the coordinate system of the object and click **Open**.

Brainsight 1.7 users can take advantage of this by using the STL export feature in 1.7 to export a surface and import it into Brainsight 2.

EXPORTING 3D SURFACES

Although this function was mainly created for our veterinary neurosurgical application, it might be useful to note that any 3D surface created can be exported as AutoCad™ drawing interchange format (.dxf), VTK (.vtk), Polygon (.ply) as well as in stereolithography (stl) file formats.

To export a 3D surface:

- Select it from the list surface of 3D surfaces shown in the reconstruction manager window.
- Click **Export...**
- Select the file format to use from the format popup menu, enter a file name, navigate to the desired

Fig. 13-9

Surface created from an ROI.

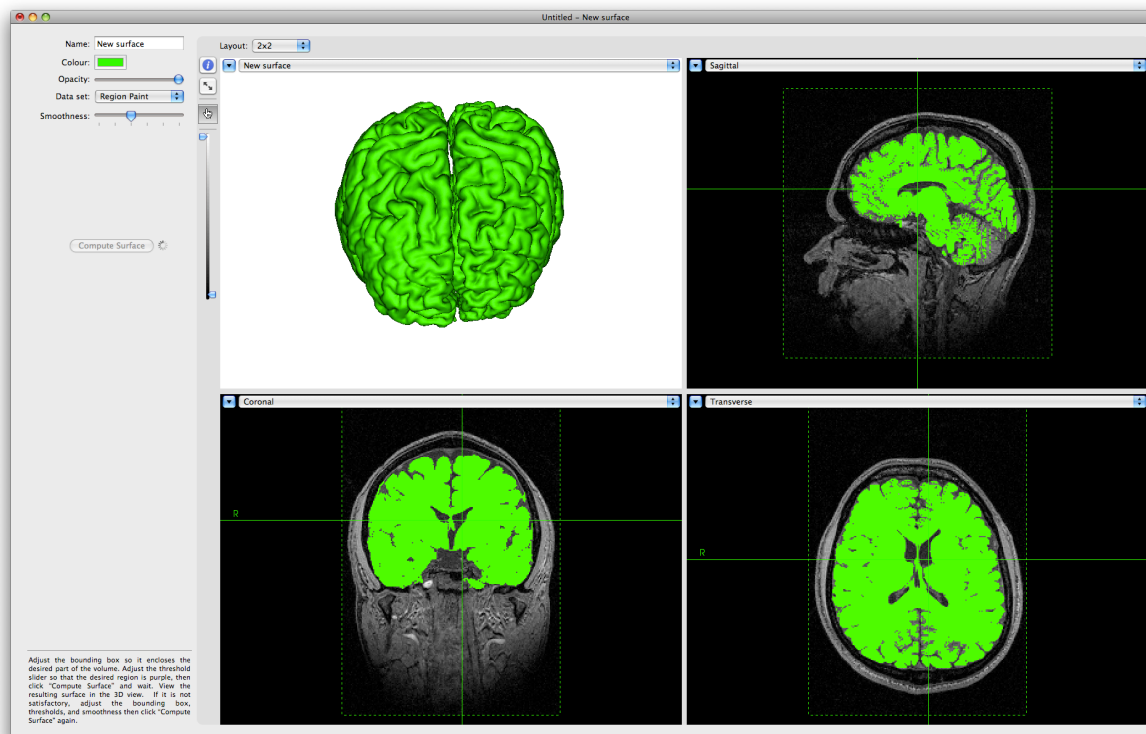

folder, and press **Save**.

- Note that when exporting curvilinear surfaces, each layer of the curvilinear surface will be exported (and the file name will have the slice number appended

to it). Using a format that supports vertex labelling (e.g. ply), the vertices will be labelled with the MR values to preserve the texture map.

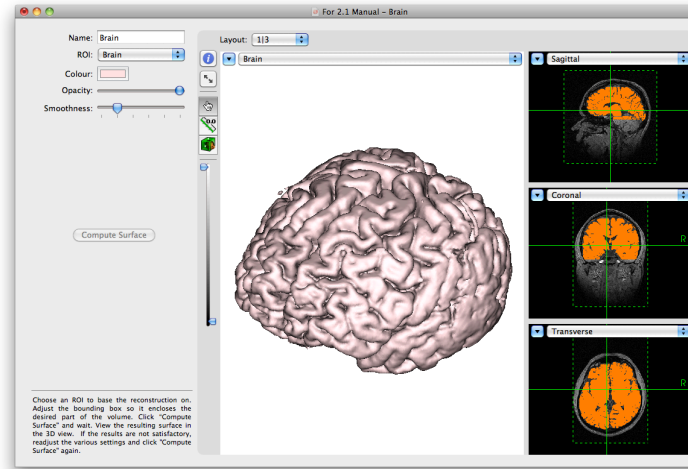
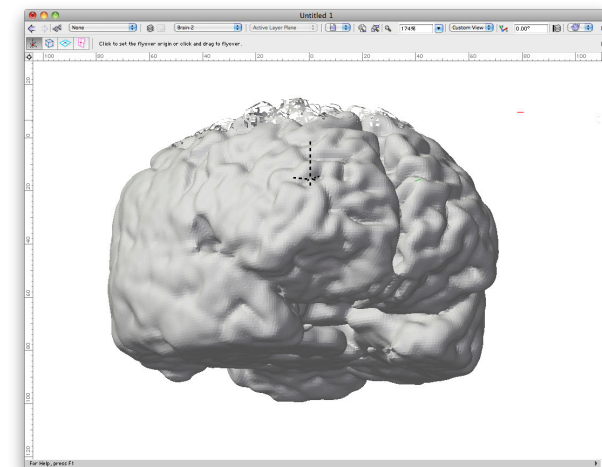

Fig. 13-10

Above: Surface created from an ROI.

Right: Same surface imported into a CAD application.



Chapter 14: Selecting Anatomical Landmarks

At the start of a TMS session, the subject is co-registered to the MR images in the Brainsight project. This is accomplished by identifying a series of anatomical landmarks on the images and on the subject. This chapter describes how to identify them on the images.

Good anatomical landmarks must abide by a few rules. First, they must be non-ambiguous, so a point in the middle of the forehead, for example, would not be good. They also have to be in the same location during the NIBS session (with respect to the brain) as they were during the scan. That means they have to be rigid, so the chin would not be good. We recommend the following points as good landmarks:

- Bridge and tip of the nose.
- The notch above the tragus of the ears.
- The outer canti of the eyes (if one of the above points are missing).

We do not recommend the tragus itself because earplugs may deflect it during the scan. To record the landmarks:

- Click **Landmarks** in the project window. The

Fig. 14-1

Landmarks manager

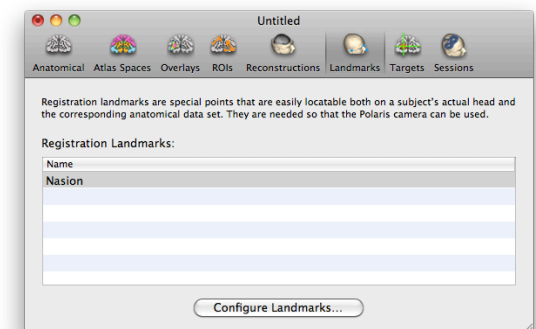

landmarks manager pane will display any landmarks created earlier, otherwise it will show an empty list (Fig. 14-1).

- Click **Configure Landmarks...** to open the landmarks window (Fig. 14-2).
- Rotate the 3D skin until you have a good view of the nose, particularly the nasion (top of the bridge). Click on it in the 3D view to move the cursor to that location. Note that a translucent green sphere identifies the cursor location in the 3D view.
- Observe the location in the transverse, sagittal and coronal views. Adjust the location by clicking in the 3D or any of the 2D slices until you are satisfied with the location.
- Click **New** to record the name.
- Note that the name field is highlighted so you can enter text that will overwrite the default name. Type in "Bridge of Nose", or "Nasion".
- If desired, you can change the colour, size or shape of the recorded landmark. For clarity, we recommend leaving it as is unless you have a reason to change it.
- Move the mouse to the tip of the nose, and perform the same steps as for the nasion. Call it "Tip of Nose" (the reason we use explicit, long winded names as opposed to TN or BN will be apparent later).
- Repeat for the left and right ears. Refer to Fig. 14-3 for examples of the landmarks.

Fig. 14-2

Landmark entry window.

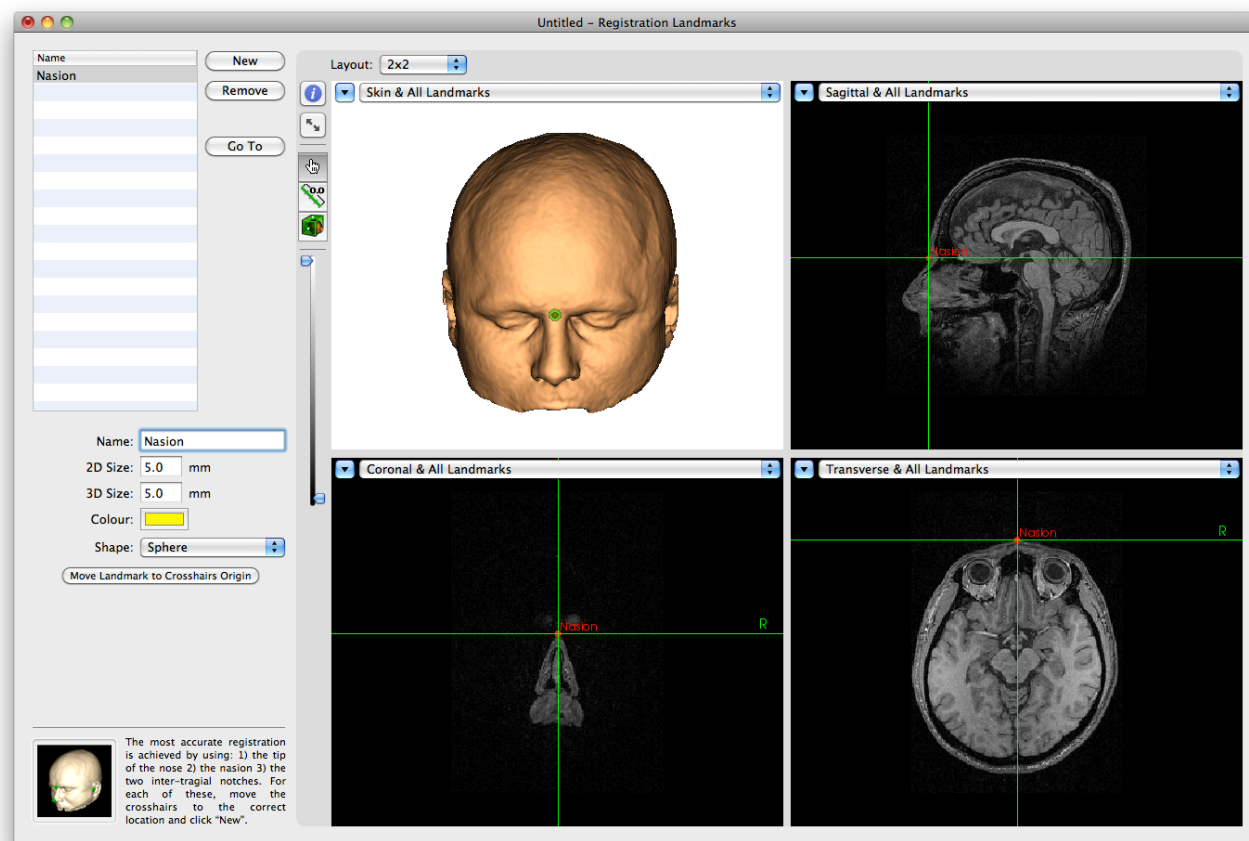

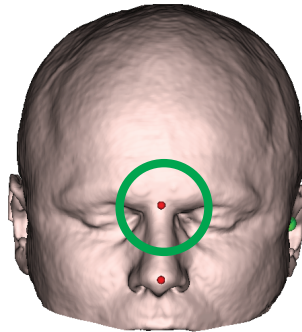

Bridge of Nose (Nasion)

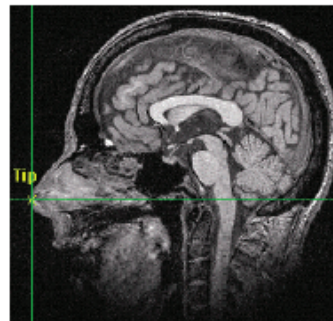
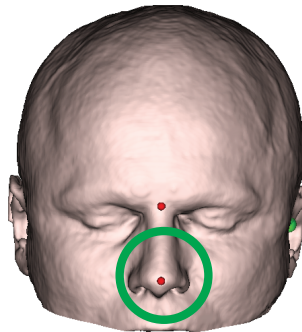

Tip of Nose

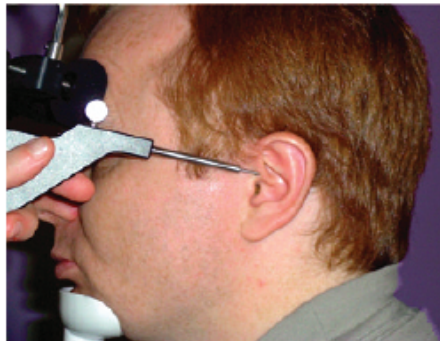
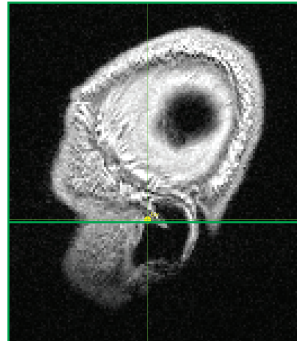
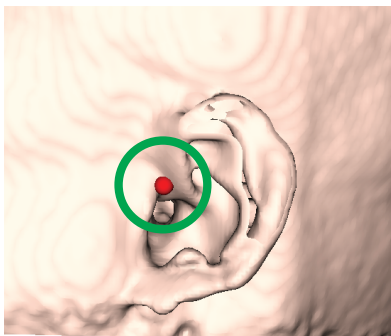

Ear (notch above the tragus)

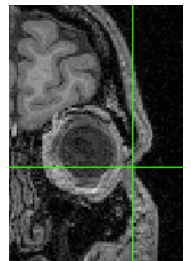
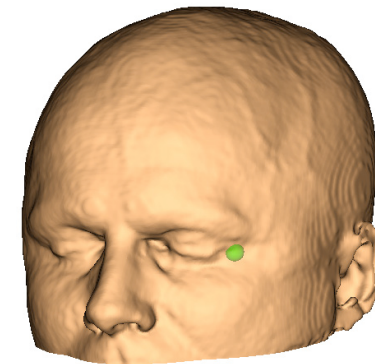

Fig. 14-4

Extra landmark: Outer canti of the eyes.

Fig. 14-3

Examples of reliable landmarks.

Pay particular attention to the notch above the tragus.

- If one of the landmarks illustrated in Fig. 14-3 are missing, consider adding the outer canti of the eyes. They are relatively unambiguous and rigid (Fig. 14-4).
- Once all the landmarks have been recorded, close the window.

Chapter 15: Selecting Targets for Stimulation

The process of selecting your target(s) is very similar to selecting the landmarks, except for the nature of the targets themselves. How you pick the target depends on your protocol. You can select a target anatomically, using MNI/Talairach coordinates, or you can pick them based on a functional overlay or an ROI.

You can define a target as a discrete point, a point with approach angle, or even a grid of points.

New to Brainsight 2.5: Integration with SimNIBS current modelling to view estimated current distribution from proposed targets and specific TMS coils. How to use SimNIBS in this context will be presented at the end of this chapter.

To start the process, click **Targets** in the project window to bring up the target manager pane (Fig. 15-1) and then click **Configure Targets...** to open the targetting window.

Fig. 15-1

Targets manager.

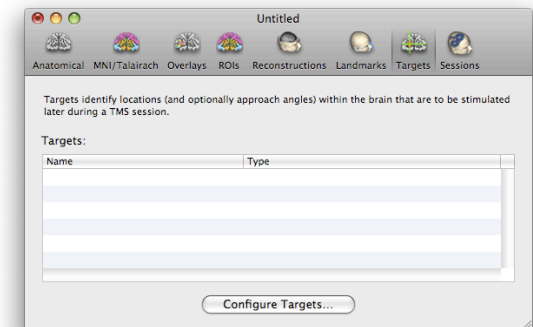

Fig. 15-2 shows a typical targetting window. In addition to the typical image views and list of targets on the left, there are additional controls on the right. The image views can be set to the traditional transverse, coronal, and sagittal views, as well as to oblique, inline, and inline-90 views. Finally, the 3D curvilinear surface (if you created one) is shown. As with all view windows, you can change these views as you like. The angle adjustment tool enables you to change the “approach” angles of the cursor, which is particularly helpful when defining

Target Positioning Tool

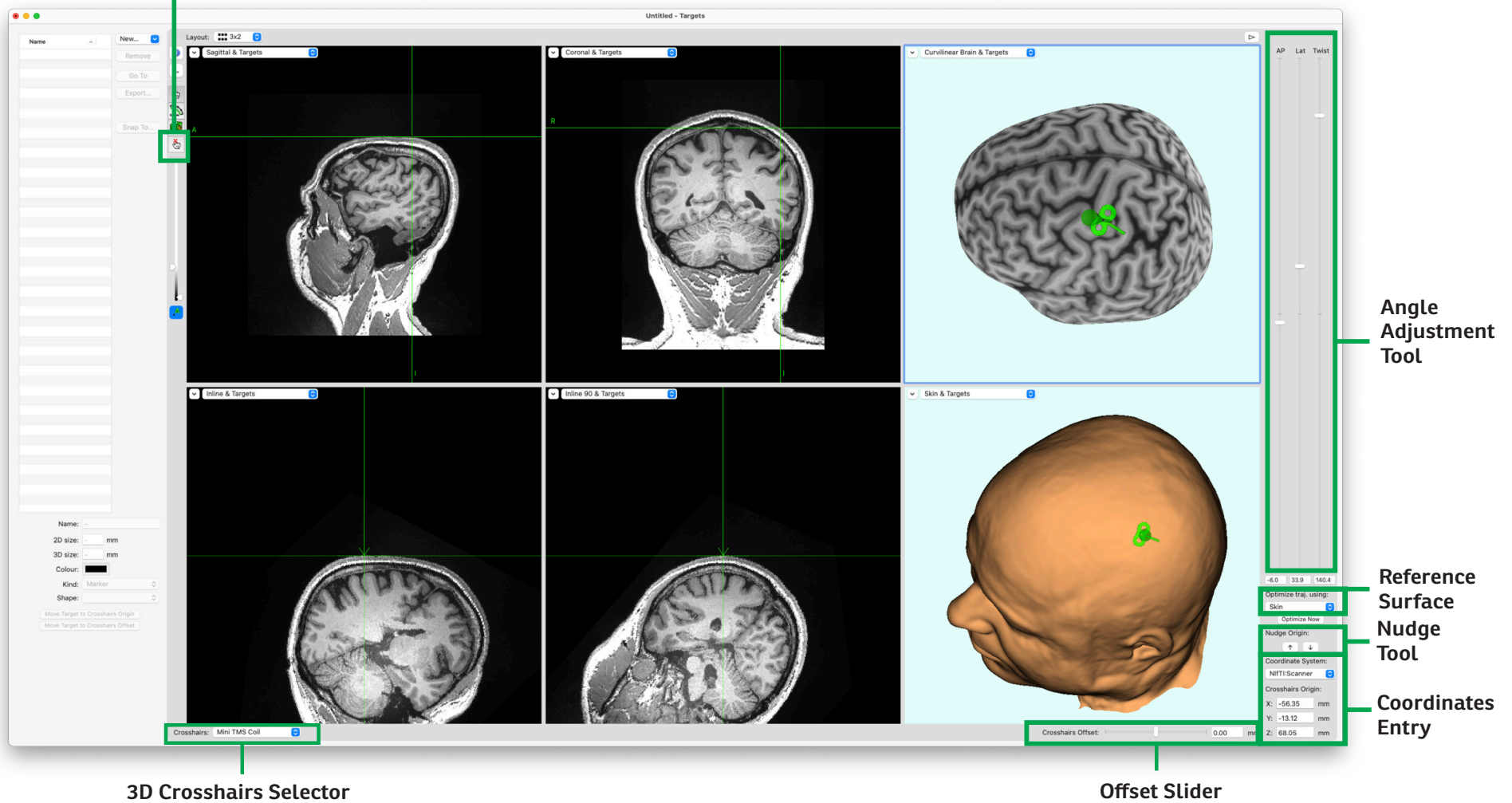

Fig. 15-2

Typical targeting window.

trajectory targets.

The targeting window introduces a few new tools (in addition to those described in Fig. 9-7). First, a new type of cursor tool, the target positioning tool, is used to adjust a target location. Second, the Angle adjustment tool provides a series of slider controls to alter the approach angles to a target. The **Optimize traj. using** is a tool to automatically optimize the coil orientation such that the orientation trajectory is normal to the selected reference surface. For example, if you select Skin as the reference surface, when you click on the brain to pick a stimulation target, the angles (as displayed in the image views and in the angle adjustment sliders) will automatically be calculated to have the coil sit flat on the skin at the exit point. This optimization occurs each time you click in an image view. Note it does not do so when you enter coordi-

nates or use the nudge tool. In this case, click **Optimize Now** to invoke the optimizer. You can always override the optimizer with the angle sliders. The nudge tool allows you to move the crosshairs up/down along the current trajectory in small increments. When used in conjunction with the target positioning tool, you can easily nudge any target up or down along its trajectory. The offset slider allows you to temporarily project the location of the crosshairs from the current location by moving the origin up and down along the current trajectory. In contrast to the nudge tool, the offset slider always keeps track of the original location of the crosshairs and the movement is relative to that original location. Note how the crosshairs shows the original location as a solid line, and the projected location as a dashed line. If you wish to make the projected location the new origin, click **Move Target to**

crosshairs offset. The 3D representation of the crosshairs can be changed to be of several preset shapes (Fig. 15-3) by clicking on the **Crosshairs** popup menu and selecting one of the shapes. Selecting the **Other...** item in that popup menu allows you to load and use a CAD file as the 3D crosshairs shape. The same file formats as described in the 3D reconstruction chapter (see "Importing 3D Surfaces From Other Software" on page 89) can be used here. The orientation of the object must match that described for the coil in Fig. 7-7. Finally, the coordinates entry tool allows you to select the desired coordinate system to view and set the location of the cursor using xyz coordinates.

Fig. 15-3

The different ways to represent the 3D cursor

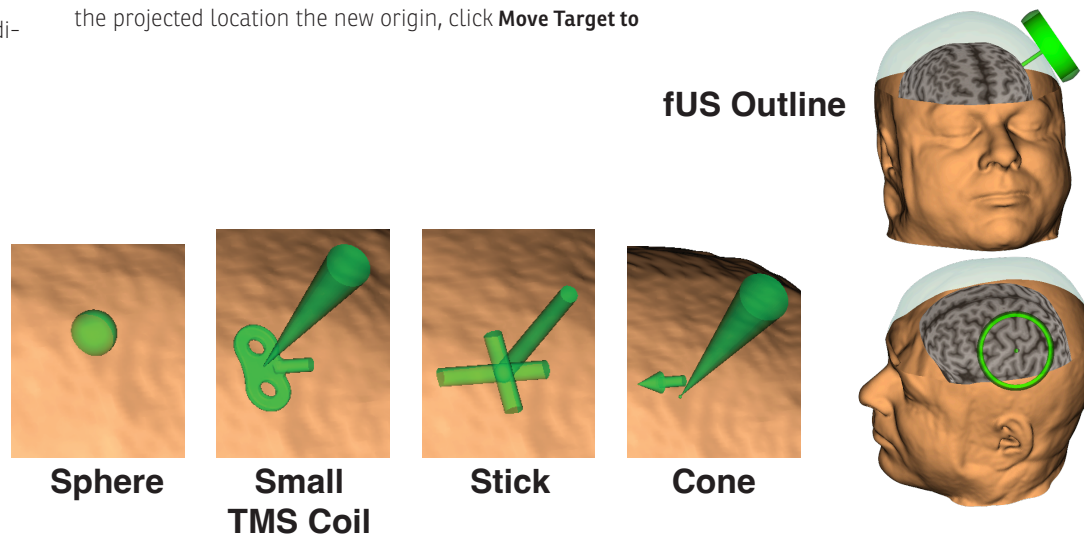

There are three types of targets that can be recorded. Marker targets (x, y, z only), trajectory targets (x, y, z and orientation), or grids (both round and rectangular, and based on markers or trajectories).

ANATOMICAL TARGETS (VISUALLY IDENTIFIED)

- Move the cursor to the desired location on the brain, using whichever image views are most helpful.
- Note that when you click on the 3D brain (or 3D skin), the orientation is set using the curvature of the 3D object set by the **Reference Surface** popup button to estimate a “reasonable” approach angle. For example, select “Skin” as the reference surface and when you click on the brain, the curvature of the brain will be used as the initial angle estimate, however the skin will be examined at that entry point and the angles will be automatically tweaked to ensure that the coil face will sit flat on the skin, ensuring a good coil orientation for that target in the brain. Use the angle adjustment slider controls to tweak the approach angles if needed.
- Click **New...**, and select the type of target to create (Marker or Trajectory).
- Enter a name for the target, and select the size, colour, and shape to suit your needs.
- If needed, tweak the location of the target by selecting the Target Positioning tool, and moving the cursor. As the cursor moves, the currently selected (active) target will move with the cursor.

MNI OR TALAIRACH BASED TARGETS

It is assumed that you performed the MNI registration described in Chapter 10. If not, perform it now.

- Choose the desired coordinate system by clicking on the popup menu button in the coordinates entry area of the window, and selecting it from the list.
- Enter the coordinates of the target in the X, Y, and Z entry fields.
- Verify visually (if possible) that the location appears correct anatomically.
- If you wish to record a trajectory-based target, adjust the approach angles using the angle sliders.
- Click **New...**, and select the type of target to create (Marker or Trajectory).

COORDINATE BASED TARGET

If you have derived a target in either Brainsight’s coordinate space (see Fig. 21-3) or the anatomical MRI’s World coordinate space (e.g. scanner coordinates found in DICOM images), you can move the cursor to that location to create a target:

- Choose the desired coordinate system by clicking on the popup menu button in the coordinates entry area of the window, and selecting it from the list.
- Enter the coordinates of the target in the X, Y, and Z entry fields.
- Verify visually (if possible) that the location appears

correct anatomically.

- If you wish to record a trajectory-based target, adjust the approach angles using the angle sliders.
- Click **New...**, and select the type of target to create (Marker or Trajectory).

fMRI BASED TARGET

Functional based targets are similar to anatomical targets in that you create the target by clicking on the images and recording the location, however, the images displayed include a functional overlay.

- If it is not already being displayed, display the functional data by opening the inspector and enable your overlay.
- Follow the steps outlined in the “Anatomical Targets” section to create and adjust your target.

CREATING A GRID OF TARGETS

In certain protocols, the target may not be a discrete point, but an array of points over a particular region (e.g. for mapping a region). Brainsight can create a series of points or trajectories called a grid. Two types of grids can be created, rectangular and circular, representing the method of distributing the nodes of the grid. Creating a grid is similar to creating markers and trajectories. The main difference is that you will select the location for the centre of the grid rather than for the discrete target, and lay out the grid based on that origin.

To create a grid:

- Select the Smart Cursor tool and move the cursor to the location that will be the centre of the grid. Make sure that the orientation of the cursor is normal to the brain (or scalp) curvature (as seen in Fig. 15-2). Remember to set the “twist” of the grid by adjusting the twist slider. The orientation is indicated by the little arrow at the base of the cursor (try zooming into the 3D view closely).
- Click **New...** and select either rectangular or circular grid. A grid will appear at the location of the cursor.
- Set the 2D and 3D node sizes and the other node attributes as you would for a singular marker or trajectory. These attributes will apply to all the nodes in the grid.
- If needed, adjust the location of the grid as needed by moving the cursor, using the Target Positioning tool. The centre of the grid will move with the cursor.

Rectangular grid (Fig. 15-5):

- Set the number of rows and columns.
- Set the grid node spacing.
- Set the naming scheme. You can select **indexed** where the topleft has index (0,0), **Symmetrical** where the middle of the grid has index (0,0) with +ve and -ve indexes, or **Alpha/Numeric** where the rows are numeric and columns are letters as found in a spreadsheet.
- The grid will initially be flat. You can wrap the grid

Fig. 15-4

Rectangular grid controls.

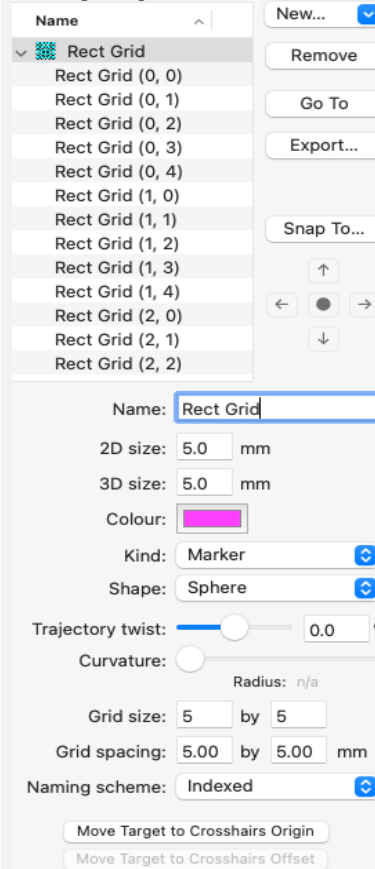
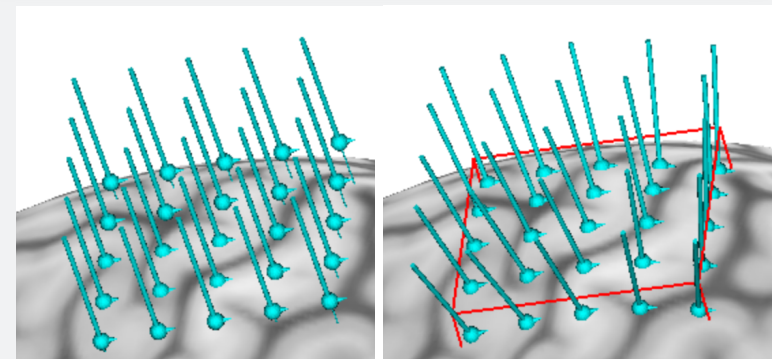
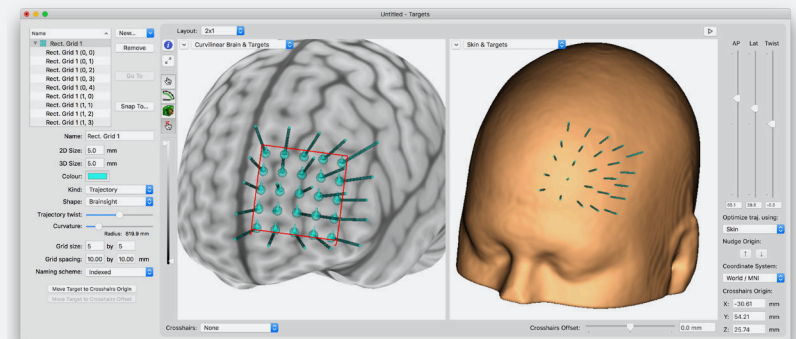

Fig. 15-6

Effect of adjusting the curvature slider.

Fig. 15-5

Rectangular grid.



First, pick the reconstruction you want to snap the grid nodes to (usually the curvilinear reconstruction). Next, pick a surface to use to orient the trajectories (usually the skin reconstruction).

Snap nodes to: Curvilinear Brain
Optimize trajectory using: Skin

Cancel Snap

to any 3D surface (e.g. curvilinear brain) using the snap function. Once you have set the grid size, spacing and location, click (Fig. 15-6) **Snap To...** . In the sheet that appears, select the surface to wrap to and the surface to use to for trajectory optimization (see Fig. 15-6).

- After the grid has been placed, you can tweak individual grid nodes in the same way as any trajectory. To tweak a node, expand the node list by clicking the disclosure triangle, then select the node and use the same techniques described earlier to tweak the node location or orientation.

You can move navigate the grid by selecting a node in the list and clicking **Go To**, double-clicking the node in the list, or by clicking the navigation arrows.

Circular grid (Fig. 15-8):

- Set the number of rings.
- Set the ring spacing.
- Set the space between the ring nodes by setting the arc length.

The circular grid consists of concentric circles. Nodes are placed at constant intervals around each circle. The distribution method can be set to one of two modes (see Fig. 15-9). Indexed mode will start around each ring and travel 360°, creating nodes at arc length intervals set by the arc length. Numbering will always be positive and increase with ring number and for each node along

Fig. 15-7

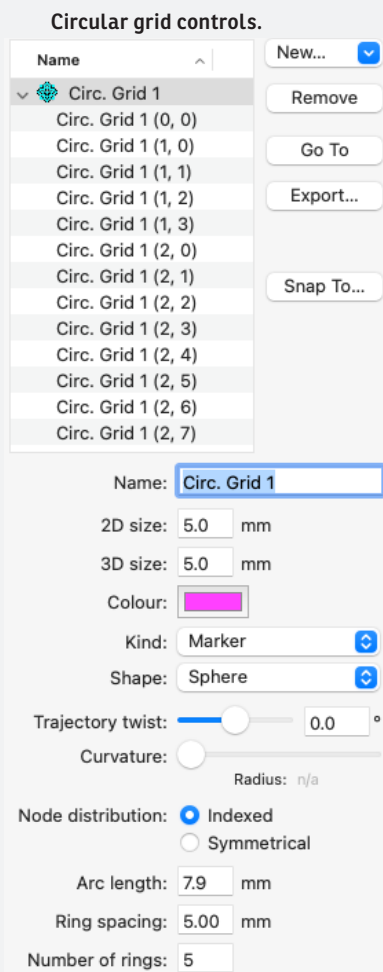

Fig. 15-8

- A: Circular grid placed on curvilinear brain surface.
- B: Circular grid placed on scalp.

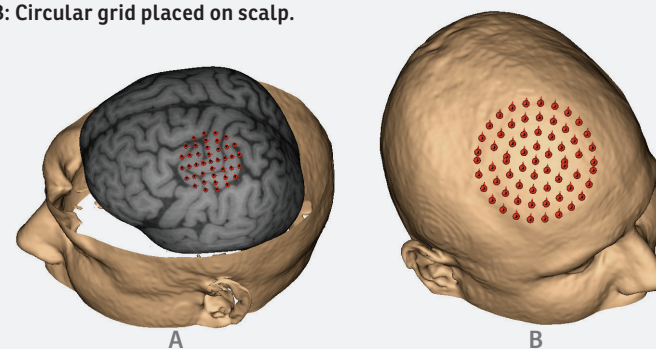
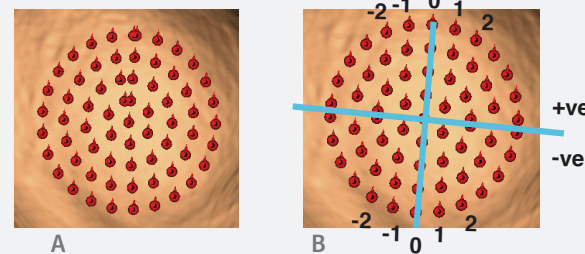

Fig. 15-9

Node distribution for indexed and symmetric grids.

A: Indexed grid. Note that in the indexed version, a discontinuity exists where the distance between the last node on the ring and the first one is less than the arc length. B: Symmetric grid. Note that the nodes have discontinuities where the disks meet the horizontal, and that the index numbers are positive and negative.



the ring. Symmetric node spacing defines quadrants as shown in figure Fig. 15-9B. Distribution of the nodes starts at the vertical axis (both at 0° & 180°) and arcs in both directions away from the starting point placing nodes at fixed intervals according to the arc length. Each node will be named according to the name of the grid, with the ring number (with +ve and -ve values, depending on the quadrant) and the index number along the ring appended (both +ve and -ve values depending on the quadrant).

CREATING A TARGET BASED ON A PREVIOUS SAMPLE

In some instances, you will want to define targets based on the results of a pilot study. The typical steps would be:

- Prepare the project file for the subject and define either a rough target to start, or do not define any targets.
- Perform the study (as described in the next chapter) and record the coil location along with the response measure that will be the criteria for selecting the ultimate target(s) for future session(s).
- After the study, follow the steps in Chapter 21 to review the study. In the review window, select the sample that you wish to use as a new target, and click **Convert to target**. Note that a copy of the sample will appear in the target list. Close the review window.
- Open a targeting window again. Select the new target in the list, and click **Go To**. Note that the

target's origin is on the scalp, pointing into the cortex.

- We recommend that targets be based in the cortex, rather than be on the scalp. To move the target into the cortex:

Click on the nudge tool to nudge the target down the trajectory.

or

Move the offset slider to project the cursor down the trajectory into the cortex, then click **Move Target to Crosshairs Offset**. The target will move from the original location to the new location.

Fig. 15-10

Why use cortical targets?

When using a scalp based target, you are placing the coil and assuming that it will be pointing towards your real target in the cortex. Any error in orientation will change the part of the cortex that is actually stimulated.

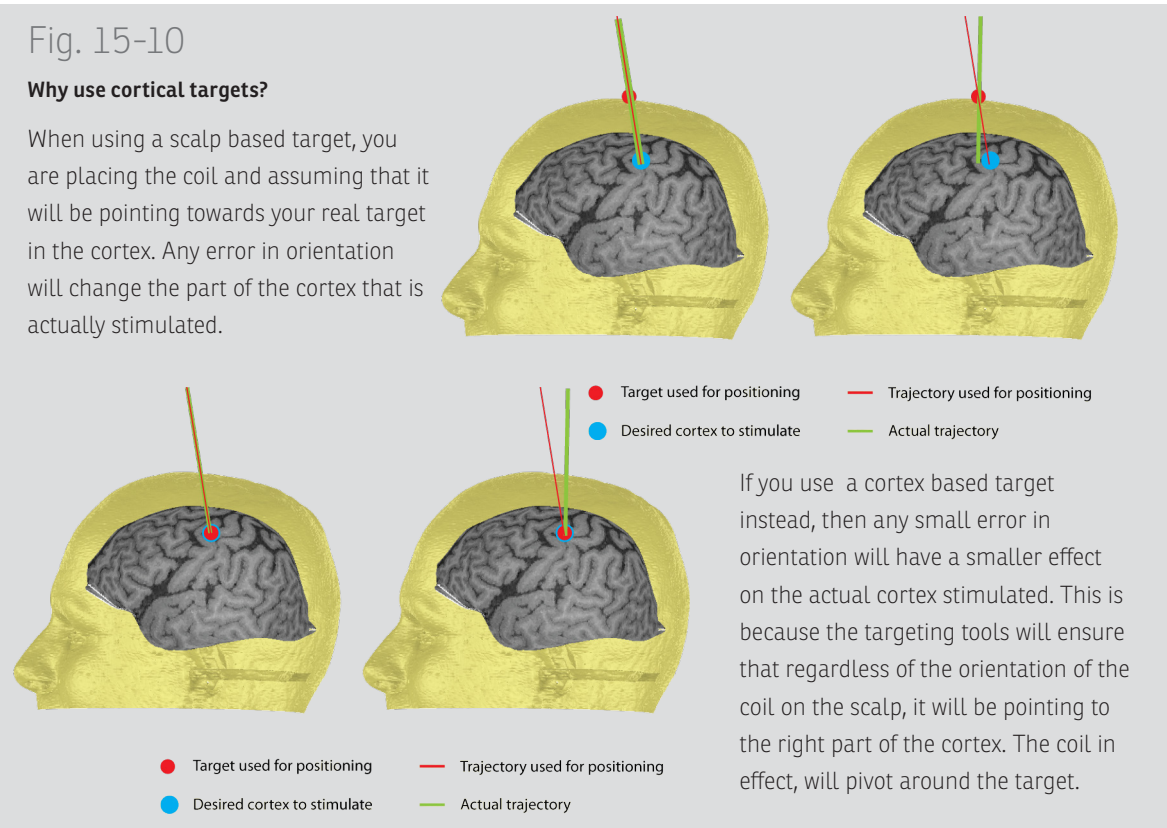

If you use a cortex based target instead, then any small error in orientation will have a smaller effect on the actual cortex stimulated. This is because the targeting tools will ensure that regardless of the orientation of the coil on the scalp, it will be pointing to the right part of the cortex. The coil in effect, will pivot around the target.

USING CURRENT MODELLING TO EVALUATE A PROPOSED TMS COIL LOCATION

The ultimate goal of navigation-based TMS is to induce a patterned electric current in the brain to achieve a goal, either interrupt a circuit by causing it to fire (supra-threshold single pulse) or to modulate cortical excitability (excite or inhibit). Up until now, selecting the target for stimulation has been a one-sided process. Pick a location in the brain and record it, then place the coil over the centre of it, assuming the maximum stimulation is under the figure-8 coil. While this in general is a reasonable way to proceed, advances in current modelling have made it possible to add an additional parameter, the estimation of the current induced in the brain for that given coil location and coil model. While the details of the underlying principles are beyond the scope of this user manual, the basics of how to use it are presented here.

DISCLAIMER: While current modelling is an exciting and promising new source of information to better inform the optimal placement of the coil, it relies heavily on a series of assumptions that include the accuracy of the segmentation of the MRI scan in representing the geometry of the various anatomical compartments (e.g. CSF, grey, white matter etc...), the assumed conductivity assigned to the various compartments as well as the 3D representation of the coil's magnetic field (among others). It is the responsibility of the user to understand the relevance and scope of information provided by modelling to make informed and appropriate decisions regarding coil placement and intensity selection.

Brainsight now has functionality to simplify the process of using a common open source current modelling framework known as SimNIBS. Before using this functionality, you will need to download and install SimNIBS (see <https://simnibs.github.io/simnibs/build/html/index.html>) and understand the basics of how it works. Brainsight replaces much of the UI portion of SimNIBS with the targeting window, so focus on the installation and use of the head reconstruction pre-processing step as this is needed prior to using it in Brainsight. The Brainsight project itself needs to have been created using the **New SimNIBS Project** option described in "Create a New SimNIBS-Based Project" on page 63.

Strategy for using current modelling

There are inherently two steps in determining the correct location and orientation of the coil. Identify the target region to stimulate, then propose locations of the coil on the scalp that will maximize the induced current in that target while minimizing it elsewhere. The simplest use of current modelling would be to use this proposed target as an input into the current modelling software, have it do the math, and display the results in Brainsight for

Fig. 15-11

Left: Typical targeting window with SimNIBS 3D objects and simulation controls. Right: Closeup of the controls & coil list

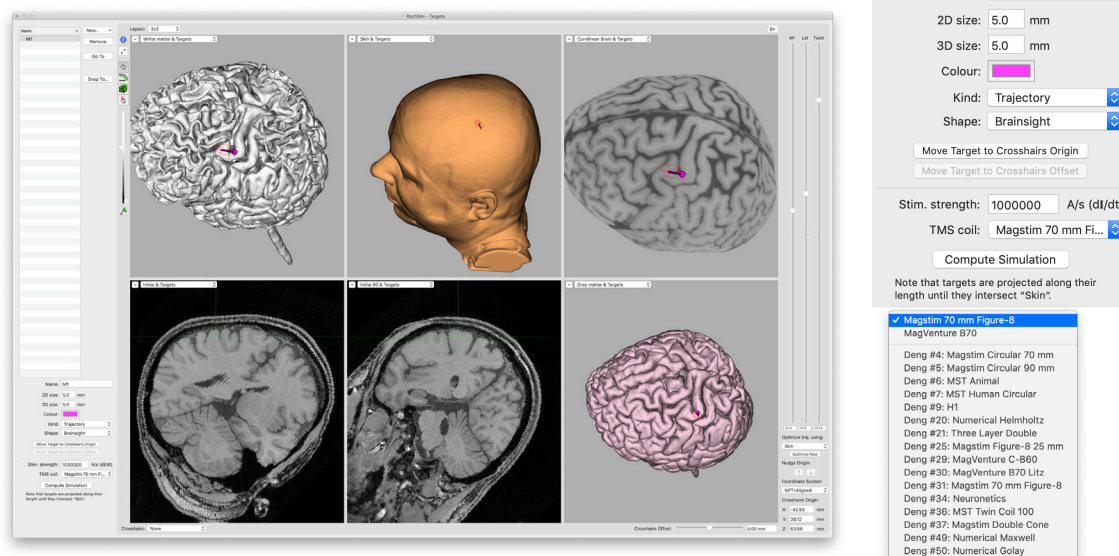

evaluation. To perform this operation:

- Select the proposed target from the list of targets
- Enter a stim strength in the field. The default is 1000000. For more information on the appropriate stim strength, see the appropriate publications or the display of your TMS device. Otherwise, use the results as a relative display only.
- Select your coil from the popup. Note the coils supported are based on the theoretical values (see Deng, Lisanby & Peterchev: “: Electric field depth-focality tradeoff in transcranial magnetic stimulation: simulation comparison of 50 coil designs”, Brain Stimul. 2013 Jan;6(1):1-13. More coils will be added as needed **(so contact Rogue Research to vote for your coil)**).
- Click **Compute Simulation**. Note that this step may take more than a minute with no visual progress indicator. The calculation is performed in the “background” (separate computational threads), so you can perform other tasks in Brainsight while you wait.
- Once complete, the result will appear as an overlay. (see Fig. 15-12).
- Open the Inspector control and select the **E-Fields** tab. Select the Target and adjust the threshold.
- Move the cursor along any surface and observe the current value at that point in the inspector window.

NOTE: While the target was selected in the cortex, the

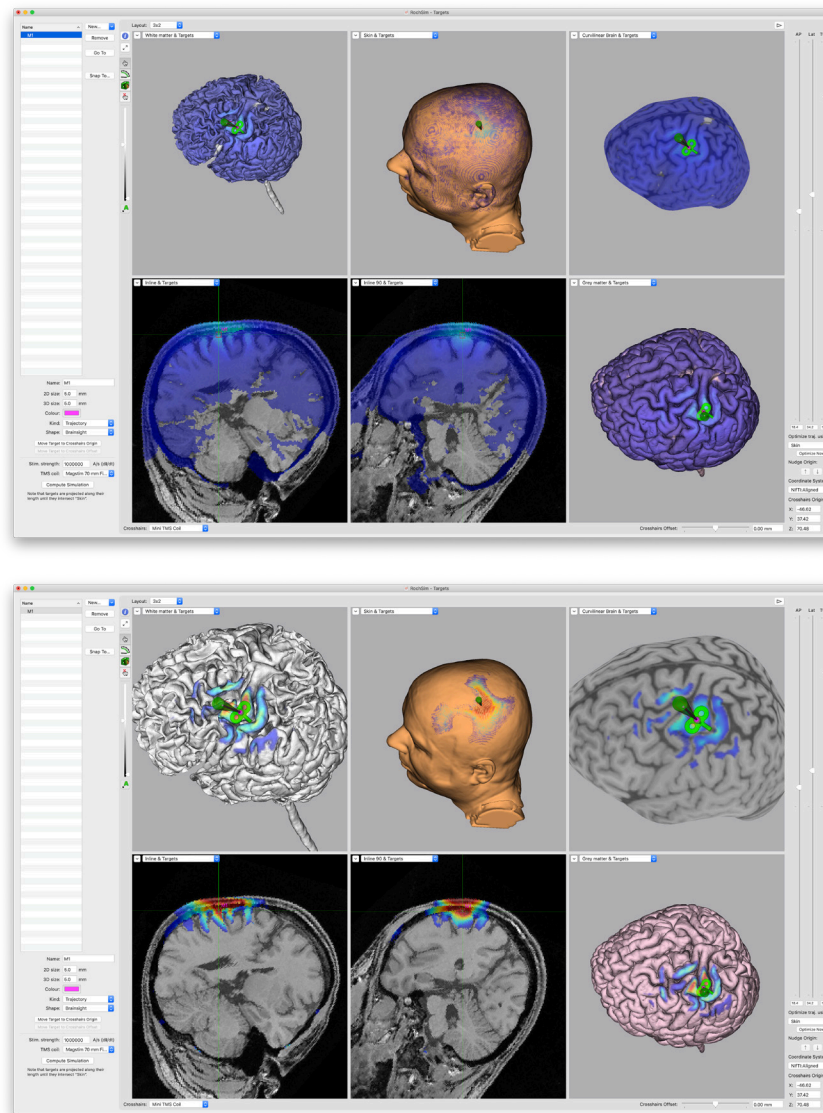
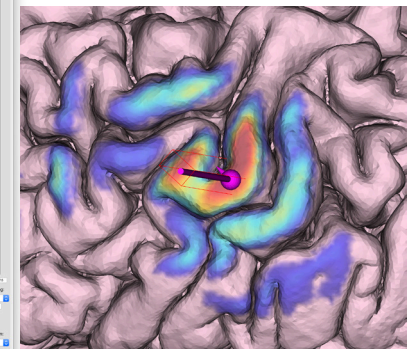
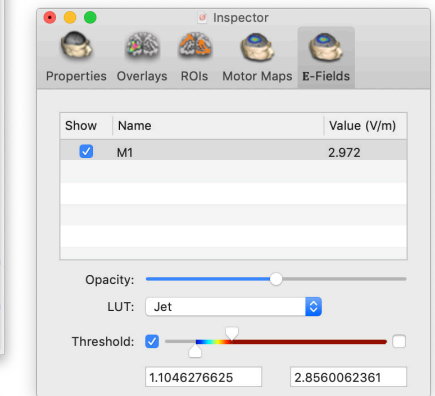

Fig. 15-12

current model display. Top left: Unthresholded result; Bottom left: thresholded version.



target required for SimNIBS is the actual location and orientation of the coil pointing to that target. Brainsight automatically back-projects along the trajectory to the skin object (as defined by the reference surface popup described in Fig. 15-2).

In addition to using discrete targets, the grid tool can be used to create a series of tightly spaced proposed targets for evaluation.

- Use the grid tool to create a grid centered over the target
- Set the spacing to be tight (e.g. 2-3mm). Make sure not to forget to set the coil twist angle.
- Use the **Snap To:** function to wrap the grid on the cortex using the skin to optimize each trajectory
- Expand the grid item in the target list and select them all. Enter the stim intensity, select your coil and click **Compute**. Note that it will take several minutes to calculate for the entire grid.
- Once complete, open the Inspector window. Select the currently displayed node and set the threshold. Note that you cannot set them at the same time (this will be fixed in a future version). Select the lower threshold number in the field and Click **File->Copy** to copy the number.
- Select all the node entries in the Inspector list, and then paste the number in the lower threshold (setting all of them to the same value).
- Repeat the process for the upper threshold.

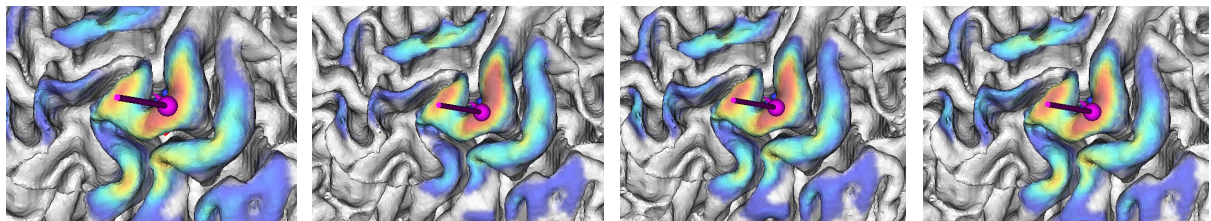
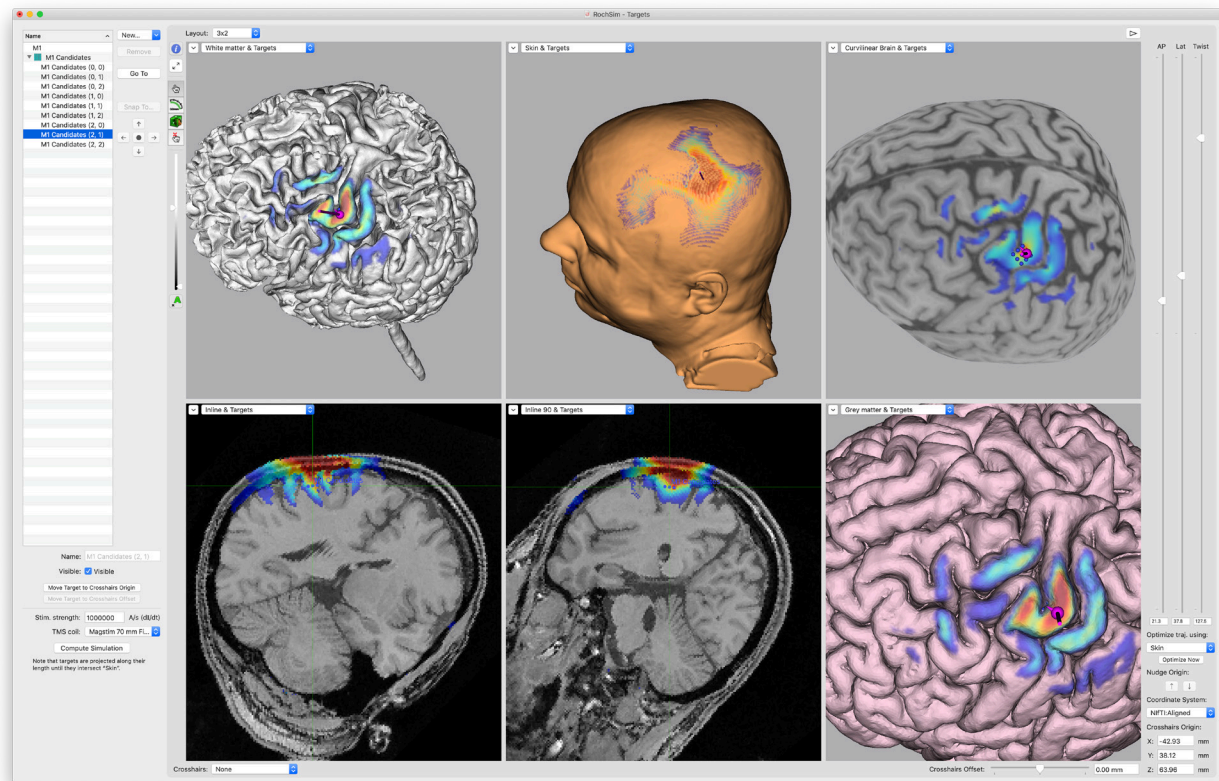

Fig. 15-13

Using a tight grid to determine the best location for the coil.

- Use the arrow buttons in the grid controls to navigate from one grid node to another and evaluate the current distributions (Fig. 15-13).
- Use the best one as your TMS target in the subsequent TMS session.

USING ACOUSTIC MODELLING FOR FUS TARGETING

The appeal of focused ultrasound for neuromodulation is the potential to reach deeper targets than possible with TMS. It is important to note that fUS is an emerging tool where best practices for use in general neuroscience is still in development. Of the many things to keep in mind, the most obvious are:

- The mechanism of action is still debated (but getting clearer).
- The location and intensity of the focus can be significantly altered by subject anatomy with the skull being the major influence.
- Acoustic modelling is essential in determining the correct location for the transducer and sonication parameters.
- Modelling is in its infancy and not approved as a medical tool for clinical applications.
- The skull thickness, density and composition of the marrow play a significant role in how the acoustic waves penetrate into the brain. The current state of the art in characterizing these for acoustic modeling relies on 3D CT images of the subject. The use of MR

images as a substitute is an active area of research (e.g. ZTE images) and it is the user's responsibility to determine the suitability of any of these approaches for your application.

- Other logistical issues need to be solved including ensuring good coupling between the transducer and scalp and holding the transducer in the correct position and orientation for the duration of the session.

DISCLAIMER: While acoustic and thermal modelling are exciting and promising new sources of information to better inform the optimal placement of the transducer, it relies heavily on a series of assumptions that include the accuracy of the segmentation of the MRI scan in representing the geometry of the various anatomical compartments, the assumed acoustic properties assigned to the various compartments as well as the description of the transducer's output (among others). It is the responsibility of the user to understand the relevance and scope of information provided by modelling to make informed and appropriate decisions regarding transducer placement and intensity selection.

Using K-Plan modelling with Brainsight

One option for acoustic and thermal modelling is to use the K-Plan application from BrainBox Neuro. K-Plan includes its own targeting display/tool so the majority of the process will be performed in K-Plan and the transducer location can be exported from K-Plan and then imported into Brainsight.

Using BabelBrain with Brainsight

BabelBrain is a public domain (for research purposes) acoustic and thermal modeling package from the laboratory of Samuel Pichardo at the Hotchkiss Brain Institute of the University of Calgary. Brainsight has implemented a similar integration as we have with SimNIBS. In order to use BabelBrain, you will need to install it (<https://proteusmri.github.io/BabelBrain/installation.html>) and you will also need to install SimNIBS as BabelBrain uses the Charm segmentation pipeline included in SimNIBS to process the T1 (and T2 if available) MR images needed for simulation.

Using BabelBrain successfully requires that one understand the overall strategy behind the tool. In general, the location of the focus from the transducer in the brain will not follow a straight line, but will curve, largely due to the inhomogeneous distortion of the acoustic beam while penetration through the skull. The overall strategy then, will be to obtain an initial estimate of the acoustic distribution and then to estimate the main component of the direction the beam deviation and to generate a new, synthetic target that when aimed for, will result in the curved beam reaching the original target. A good analogy to this is in archery. Imagine shooting a first arrow at a distant target and noting the arrow landing off target due to the wind. Purposefully aiming in the direction opposite to the noted error of the first arrow should result in the second arrow hitting the target.

Be sure to read and understand all the documentation

regarding BabelBrain as setting the simulation parameters are beyond the scope of this manual.

Overall steps:

- Process the T1 images using the CHARM pipeline (“Using Current modelling to evaluate a proposed TMS coil location” on page 104).
- Create a SimNIBS project with Brainsight.
- Identify the target in the brain with an initial angle of approach and save as a trajectory.
- Use the fUS simulation button to invoke BabelBrain.
- Generate the mask (step 1).
- Generate the acoustic model.
- Use the Babel visualization to estimate a lateral correction to the transducer location to correct for beam bending.
- Using the correction values, re-run the simulation, then run the thermal modeling.
- Close the BabelBrain window and note the new modified target created in Brainsight.

Identifying the target

- Make sure you are using an image display layout that includes the 3D scalp, inline and inline-90 views. These will be helpful in determining the optimal trajectory.
- Use the cursor to navigate to the middle of the region to stimulate (either visually or entering

Fig. 15-14

Stimulation target with initial AP & Lat angles set to reach target from optimal scalp location.

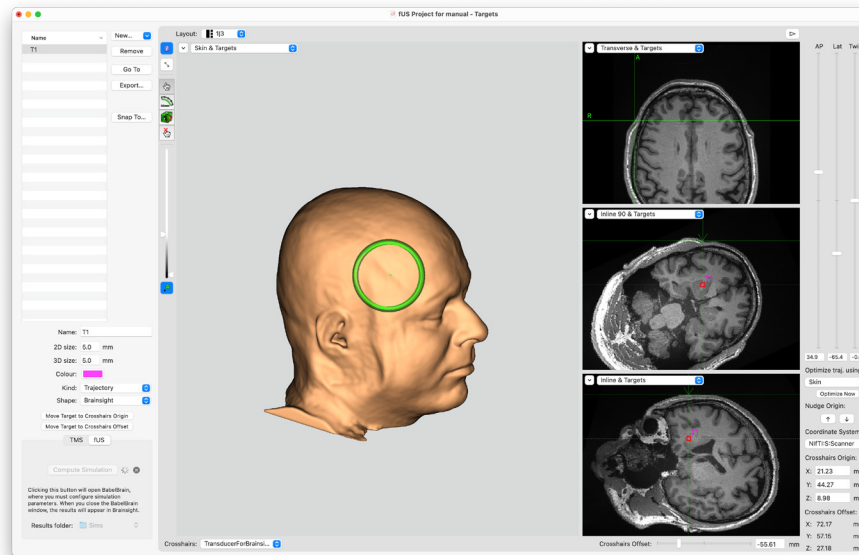

coordinates or any other method appropriate to your application.

- Using the Crosshairs offset slider, project the offset cursor back towards the skin surface (it does not have to be precise and can be tweaked at will). This will allow you to pivot the trajectory (next step) with the deep target as the pivot point while simultaneously being able to see the scalp entry location.
- Using the AP slider and while watching the Inline view, change the AP angle to minimize (visually

assess roughly) the distance from the scalp to the target.

- Using the Lat slider and while watching the Inline-90 view, adjust the angle such that the virtual transducer will be sitting flat on the scalp.
- Tweak the AP and Lat sliders to finalize the proposed transducer location and orientation to reach the target.
- Create a target by clicking **New->Trajectory at**

Crosshair Origin

Initiating the simulation

- Click fUS at the bottom-left of the window to select the fUS simulation
- BabelBrain creates multiple files for each simulation. In order to keep them organized, click on **Results Folder** and create a new folder to contain all the files that will be generated. A good place to put the new folder is in m2m_XXX folder created from the CHARM pipeline.
- Click **Simulate**. This will initiate BabelBrain and pre-populate the simulation parameters with the imaging-specific values (Fig. 15-15).
- If you do not have a CT, or CT “equivalent” MR data set, leave the “Use CT” setting to **No**. Otherwise,

Fig. 15-16

Top: Calculate masks window prior to the calculation.

Bottom: Display of the resulting tissue mask.

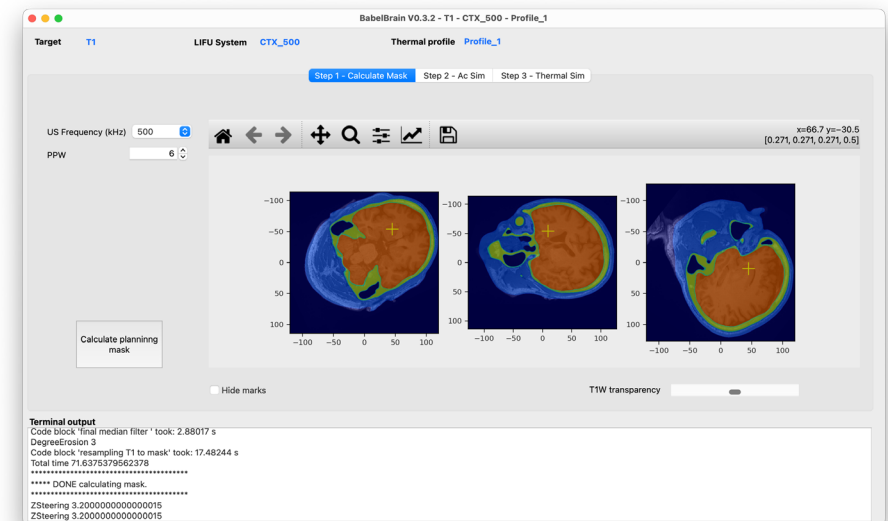
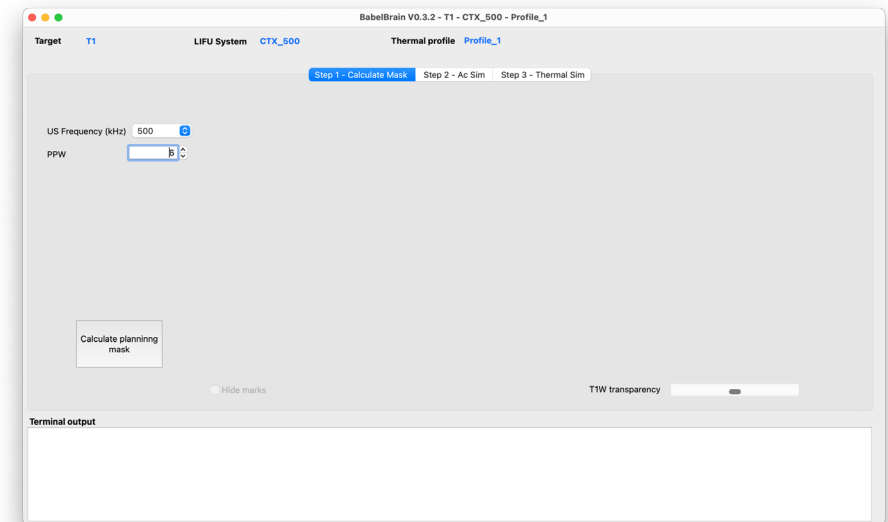

Fig. 15-15

Initial Babel Brain screen with a thermal profile and transducer selected.

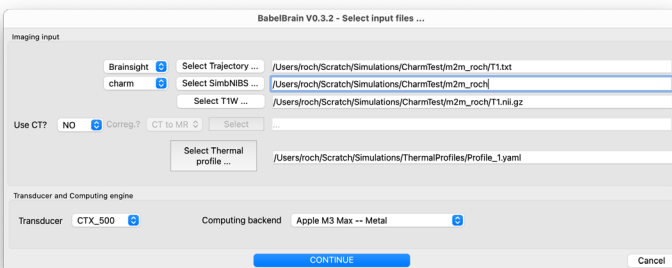
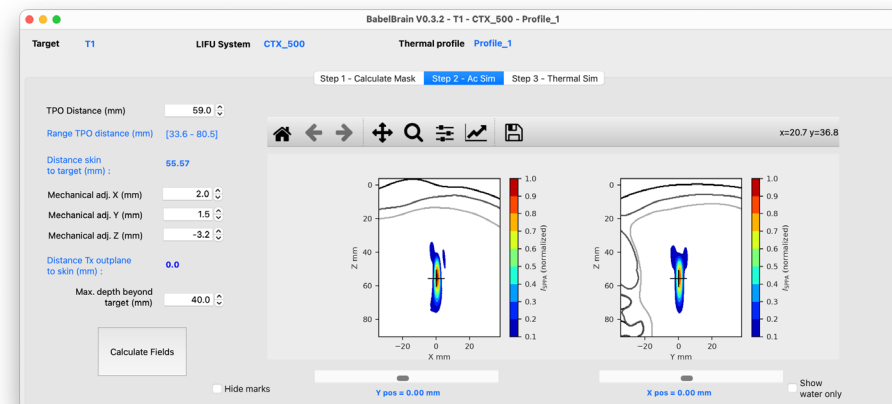
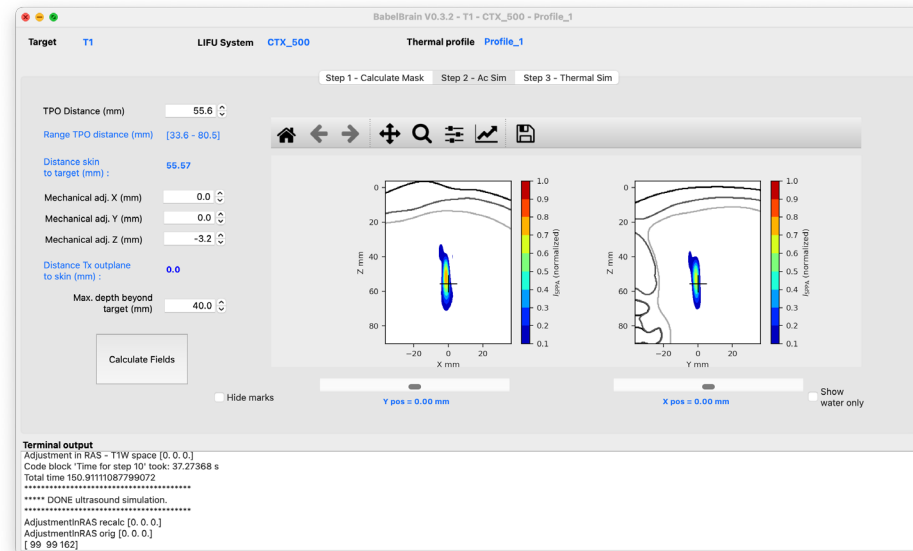

Fig. 15-17

Top: Initial acoustic model. Note the location of the focus w.r.t. the target.
Bottom: Second calculation with x & y correction offsets entered. Note the improved location of the focus w.r.t. target.

select the appropriate and select the images.

- Select the correct thermal profile (a “Thermal Profiles” folder with multiple profiles were included in the BabelBrain disk image).
- Select your transducer model and click **CONTINUE**.
- The next step is to create the tissue mask needed to ultimately calculate the acoustic and thermal simulations (Fig. 15-16, top). Select the US frequency associated with the transducer and the PPW (or use the default).
- Click **Calculate Planning Mask**. Note this step will take several minutes depending on how many GPU cores your computer has. If you expect to do a lot of modelling, consider using a recent Macintosh with Apple silicon (e.g. M3 chip), significant memory (e.g. 96GB) and many GPU cores.
- Once complete, the mask will be displayed in the window (Fig. 15-16 bottom). Examine the mask to ensure it is a faithful labeling of the volume (skin, bone, brain). Click on **Step2 - Ac Sim**.
- Note that BabelBrain has estimated the distance from scalp to the target (TPO Distance). If you are using a transducer with a variable depth of focus, this would be a good estimate assuming the transducer is exactly on the scalp. Remember to add any additional depth (to the fUS depth control of your fUS system) to accommodate for the thickness of any coupling media.



- Click **Calculate Fields**. This will again take a few moments, however less than the calculate mask step. Once complete, it will be displayed in the image panes (Fig. 15-17 top).
- Examine the location of the focus of the beam w.r.t. the target. Use the sliders under each view to appreciate any discrepancy. Note the distance in the x & y directions that the focus would need to move to be better centered on the target.
- Enter proposed x & y offsets into the Mechanical adj x & y fields. Click Calculate fields again to calculate a new simulation with the adjusted position. When complete, the new results will be displayed (Fig. 15-17 bottom).
- If the simulation yielded acceptable results, click on **Step 3 - Thermal Sim** (optional). Click **Calculate Thermal Fields**. The results will be displayed after a few seconds (Fig. 15-18).
- Adjust the Isppa intensity by editing the value in the field.
- You can examine the location of maximum temperature in the brain, skin and cranium by clicking **MTB**, **MTS** & **MTC** respectively.
- Export a CSV summary by clicking **Export Summary CSV**, navigating to the desired folder in the resulting dialog, entering a filename and clicking **Save**.
- You can export the thermal profile as a NIfTI file by clicking **Export Current Thermal map (.nii.gz)**. Take

Fig. 15-18

Acoustic pressure (from previous step) and thermal profile displayed.

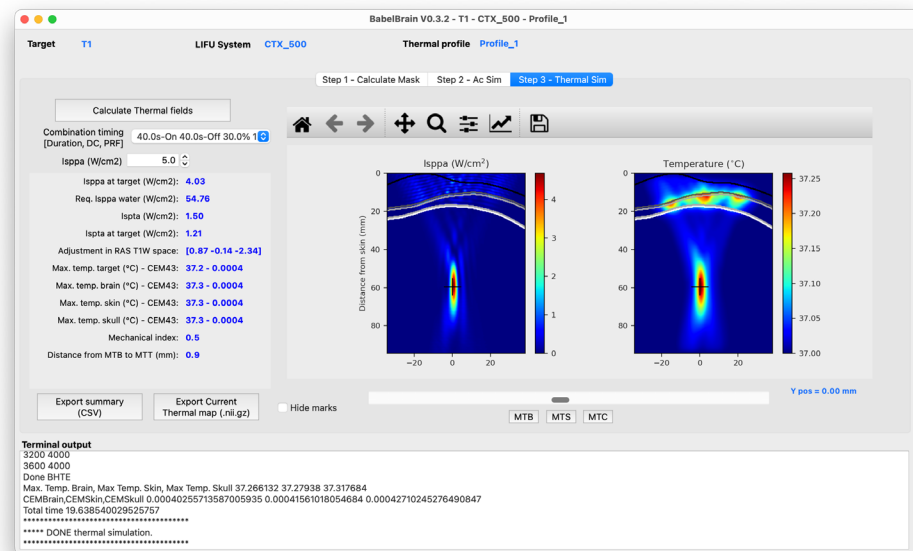

note of the filename and location as it is not possible to select a location or name.

- When you are satisfied with the simulation (and satisfied with the x & y adjustments that moved the focus to the target), close the simulation window.
- Note that a new target has been created in Brainsight whose name is <NAME>-Mod where <NAME> is the name of the original target and the acoustic model has been attached to the new target and is displayed (Fig. 15-19).
- To adjust the threshold (and other visual attributes) of the overlay, open the Inspector by clicking the inspector button and selecting the fUS tab. Each simulation will be displayed in the list. Select the simulation and edit the appropriate attribute.
- While it is not yet possible to include the thermal profile directly as part of the simulation, if it was saved as a NIFTI file, it can be loaded as a standard overlay. See “Chapter 11: Image Overlays” for more information on loading a NIFTI file as an overlay.

Fig. 15-19

Final display of the acoustic model in the Brainsight targeting view. Note the additional target representing the suggested target location to account for beam aberration.

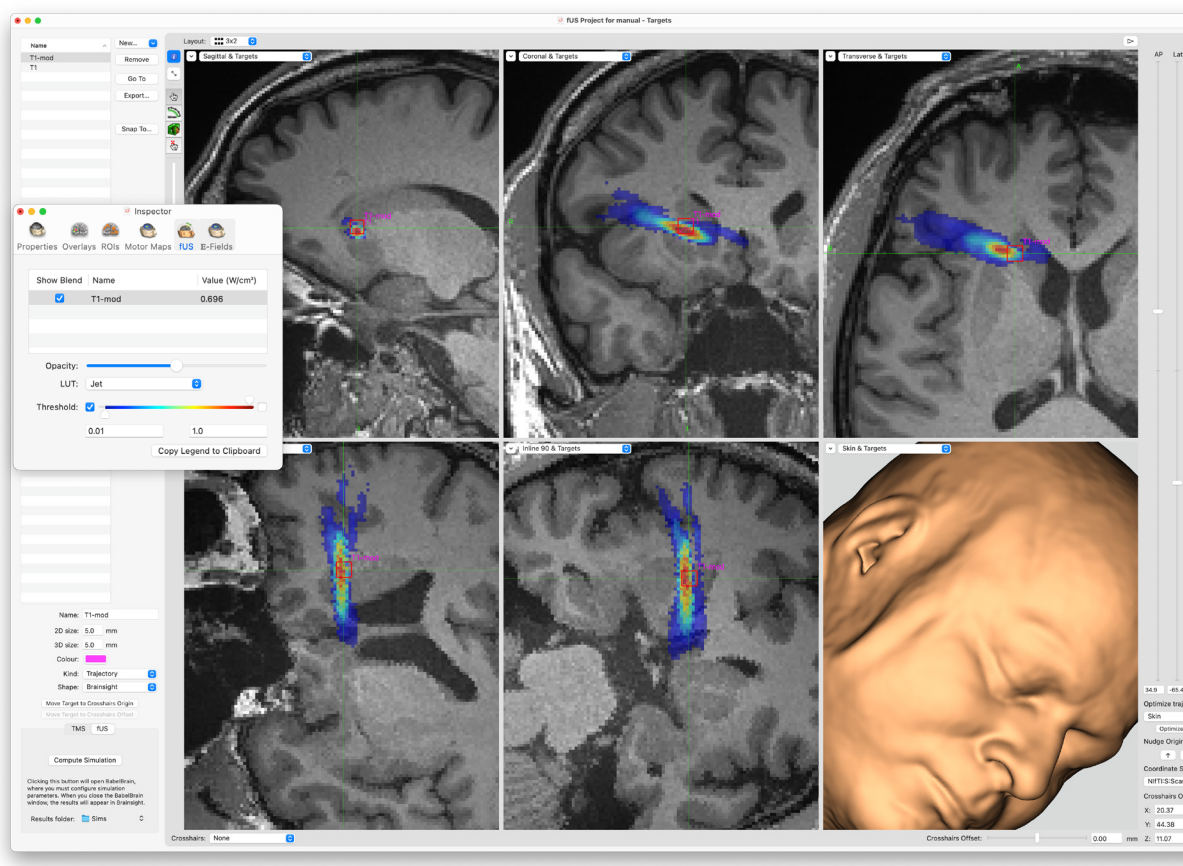

Chapter 16: Performing the Study

Up to this point, you have spent several minutes or more preparing for this part: performing the NIBS session. The description of many parts of this procedure will be deliberately vague because they depend on the nature of your experiment. Focus will be paid to the aspects that are relevant to neuronavigation, and the examples given to subject setup will use our subject chair and coil holder apparatus. Refer to the chapters regarding the computer trolley and subject chair if you are using them.

Before you can start a session, you will need to have calibrated your tool (see Chapter 7) and performed the steps in preparing a project file (start at Chapter 9 and work your way back to here). Note that we will use the TMS coil as the example tool here however a fUS transducer will use the same process unless specifically noted.

PREPARE THE TRACKED TOOLS

You will require the subject tracker, tool tracker and pointer for this section.

Caring for the reflective spheres

Make sure the spheres on the coil tracker, subject tracker and pointer are free of scratches, blemishes or dirt. If they are dirty, try using an alcohol wipe to gently wipe off the dirt, and allow the sphere(s) to dry before use. Take care not to rub too hard and rub off the coating of micro-spheres. If the sphere is too dirty to clean, or scratched, replace it by:

- Removing the old sphere by firmly pulling it straight off the mounting post.
- Using a glove or plastic bag over your hand (to keep the oils of your fingers off the new sphere), take a spare sphere and push it onto the mounting post. You should feel a snap when it is correctly seated.

Both the subject's head and the tool will be tracked by the position sensor camera. The tool tracker should already have been fixed to the TMS coil or fUS transducer and calibrated following the instructions outlined in "Chapter 7: Calibrating Your Tool" on page 51.

PREPARE THE SUBJECT

The orientation of the subject will depend almost exclusively on your experiment. For example, if you are stimulating frontal areas of the brain, you will likely want the subject in a reclined position. Alternatively, if your

experiment involves the presentation of visual stimuli, an upright position for the subject might be best.

Prepare and attach the subject tracker

Brainsight now has two types of subject trackers. One has the traditional spheres (like the coil tracker and pointer) and the second employs a plastic, light-weight body with flat disk reflectors instead of the spheres. The former has the most flexibility in being visible to the camera from different angles while the latter is less intrusive and can be directly affixed to the forehead with double-sided tape (e.g., “wig tape”) but can only be used on the forehead and requires a more direct line of sight. Experiment with both to learn when one is more appropriate than the other in your particular setup.

As with the coil tracker, the sphere-based subject tracker is held in place using a hexagonal rod. The diameter of the rod as well as the receptacles are smaller than that of the coil tracker to prevent confusing them. The subject tracker will be held to the subject’s head using either an elastic head strap (with a flexible pad and hex rod receptacle) or the tracker glasses (Fig. 16-2).

Using the head-strap

Note that the receptacle in the head strap has two holes. One will orient the tracker horizontally and the other vertically.

- Decide which one to use based on the expected location of the camera. If the camera will be low (e.g. eye level), then use the vertical hole so that

Fig. 16-1

A: Chair in a reclined configuration to provide convenient access to the frontal areas.



B: Upright configuration for access to parietal or occipital areas.

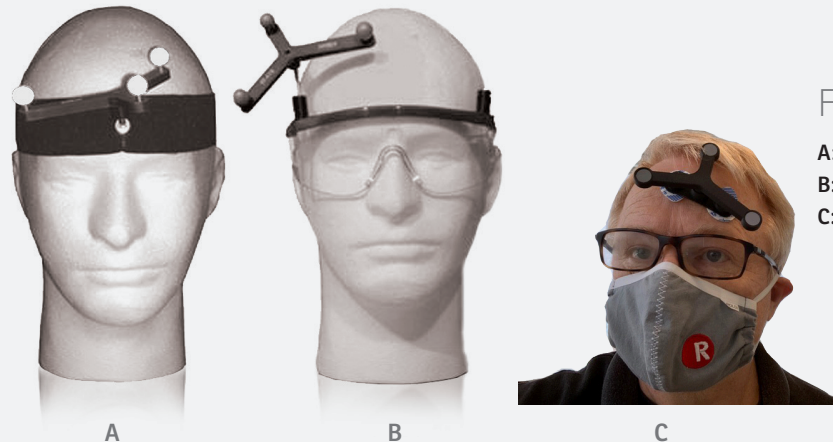

Fig. 16-2

A: Head strap for attaching trackers.

B: Glasses with tracker mounts.

C: Stick on tracker

the subject tracker will be facing horizontally. If the camera will be high looking down, then use the horizontal hole so that the tracker will be facing up.

- Loosen the set screw in the receptacle and insert the hex rod. Tighten the set screw, taking care to ensure that the set screw comes into contact with a face of the hex rod.

Using the glasses

The glasses have receptacles on both ends of the frame.

- Select the one that will ensure that the tracker will be away from the coil.
- Loosen the set screws in the receptacle and insert the hex rod. Tighten the set screws, taking care to ensure that the set screws comes into contact with a flat face of the hex rod.

Fix the subject tracker to the hex rod by loosening the set screws in the receptacle, mount the tracker on the hex rod, and tightening the screws taking care to ensure that the set screws comes into contact with a face of the hex rod.

Ensure that the position of the subject tracker is such that the Polaris will be able to see the tracker, and that its location will not interfere with the coil location. You will have the opportunity to confirm the visibility of the tracker during the start of the TMS session.

PREPARE THE HARDWARE

If during the NIBS session, you wish to automatically

record the tool location using the TTL signal from the stimulation device, connect the TTL output of the device to the Brainsight computer. If you have a recent trolley-based iMac from Rogue Research that has a metal case at its base or a small metal box called an "I/O box", or a smaller box called and "Analog Receiver" (we often refer to it as the trigger box), connect the BNC cable from the trigger out of the stimulator to one of the "trigger in" ports. Note that there are two trigger in ports to allow you to monitor two coils at the same time.

If you do not have one of our interface boxes, or are using your own computer, contact Rogue Research to purchase a separate TTL trigger box. Note that the "X-Keys" box previously provided by Rogue is no longer supported. Contact Rogue Research to obtain the replacement trigger box.

Note: If you are using a Magstim system and using our early model I/O box (before fall 2010), you may need a special TTL output adapter to have access to the TTL signals. Magstim has released more than one version of this adapter, and some of them will not work. The only ones that will work reliably is the adapter with the TTL pulse extender (EMG Interface Module P/N: 3901-00) or the more recent round adapters by Jali Medical (USA only). The EMG interface module can be identified by the presence of small switches (DIP switches) that are used to configure the length and direction (trigger up) of the TTL pulse. The reason is that the width of the TTL pulse (without conditioning) is too short ($\approx 50 \mu\text{s}$) for many

Fig. 16-3

TMS Session manager window.

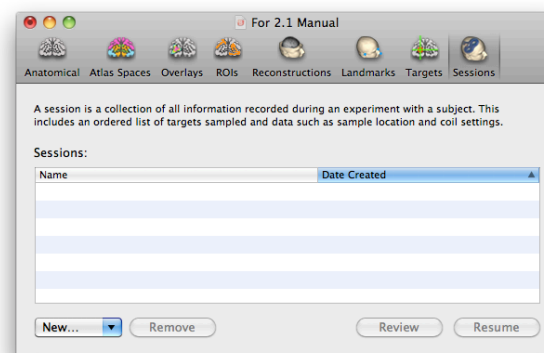

electronic devices to detect. The pulse extender extends it to about 20 ms making it easier to detect. This issue is often encountered with EMG systems as well, hence the development of the EMG interface box. The most recent adapters from Jali medical also contain a built-in pulse extender, and can be identified by the connector style to the Magstim device. If the connector is a small circuit board, it has the pulse extender. If it is a grey, plastic connector, then it does not have the pulse extender.

BEGIN A NEW NIBS SESSION

- Launch Brainsight and open the subject's project file
- Click on **Sessions** to bring up the session manager window (Fig. 16-3).

Fig. 16-4

Target selection screen.

Drag and drop the targets to use for this session from the pool of all targets on the left to the session target list on the right (or select the target on the left and click Add..)

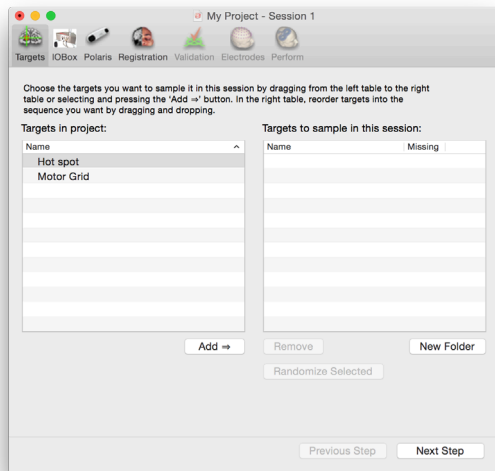

- To begin a new session, click **New->Online Session**. To resume a previously created session, select the session from the list and click **Resume**. A session window will appear (Fig. 16-4).
- The first window shows a list of all the targets defined earlier, and an empty list representing the targets to use in the current session. Either select

the target and click **Add->** or, using the mouse, drag the targets to use in this session from the list of all targets to the list for the session. Note that you can rearrange the order of session targets by dragging them up and down in the list. You can also add multiple instances of a target in the session list. This allows you to create a sequence of targets for a session that can include stimulating the same target more than once.

Fig. 16-5

I/O box configuration window

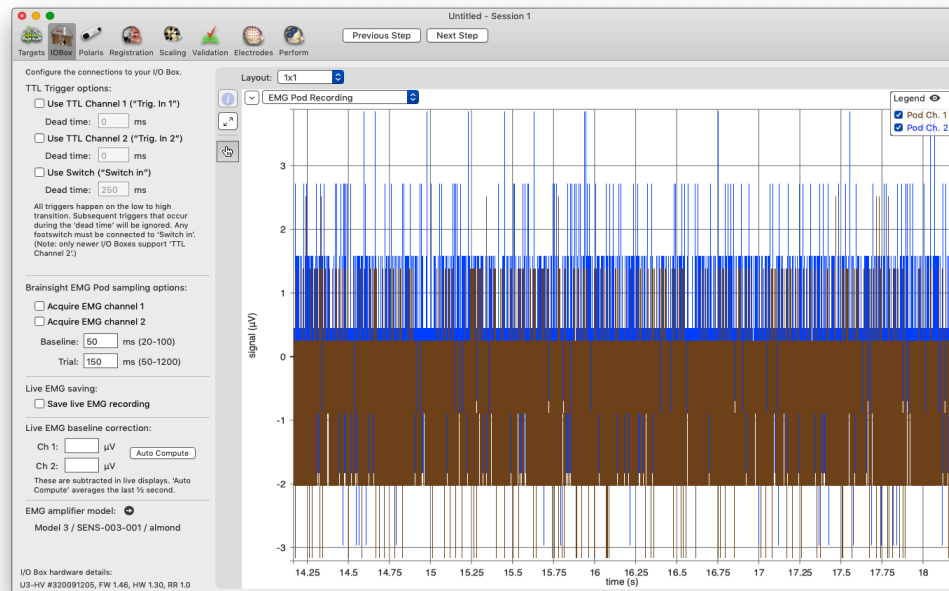

- Once all your targets are selected, click **Next Step**.

CONFIGURE THE I/O OR TRIGGER BOX

Brainsight has consolidated several hardware related functions into an “I/O box” step. This step allows you to configure the trigger options, the EMG acquisition and provides a live EMG view (when present).

Set the trigger options

During the session, you may wish to record the tool location manually. You can always do so by pressing the Sample button, but you can also do so automatically by connecting the stimulator’s trigger out signal to the Brainsight computer (see previous section).

- If you have a Brainsight computer trolley with an I/O box or Trigger box (specifically from Rogue Research) and have connected the TTL trigger output of the stimulator to the TTL trigger in of the I/O box (or connected a switch to the switch input), enable it by enabling the **Use TTL Channel x** checkbox (x=1 or 2). For rTMS, enter the pulse train length as **dead time** to have Brainsight use the first pulse in a train and ignore the rest (until the first of the next train). In certain models of the LabJack based trigger unit, you may select the type of trigger signal: Trigger on rising pulse (e.g. 0->5 V). Note that on early versions of the interface box, you need to ensure that the trigger pulse is at least 500 μ sec long. In some stimulators, this will require a pulse extender. This limitation is also common when using EMG and EEG

devices because the trigger is being recorded by an analog device with a sampling rate of 1-5 KHz. Contact Rogue Research or your TMS manufacturer for more details. Note that if you are using a recent Brainsight computer and I/O box (2010+), a pulse extender is incorporated into the box, so a pulse extender is not required.

- You can also enable the switch input and connect that to a hand-held, or foot switch.
- Note that as described on page 130, you can open a second “perform” window to track a second coil, and set the trigger in of that window to any of the TTL channels. This allows you, for example, to set one window to track one TMS coil, and have the automatic trigger connected to that TMS device and have a second window track a second TMS coil and triggered by that second device.

SETTING UP THE EMG

NOTE: A bug in Brainsight was discovered where the scaling of all EMG data acquired and stored was incorrect. As of Brainsight v2.2.13, any time an older project is opened that has the old scaling factor, Brainsight will issue a notification that all EMG data previously recorded will be automatically corrected and any new data acquired will have the correct scaling. The correction includes all EMG data, MEP values (unless they were overwritten manually) and the threshold values in motor maps. The error was in the scaling, not the raw data so any relative

measure will not be affected.

Refer to Chapter 4 for safe and correct operation of the Brainsight EMG device. If you have not already done so, apply the EMG electrodes on the subject. The EMG data from both amplifiers will be displayed live in the EMG view on the screen. You can use this to ensure that you have a good electrode contact.

As of v2.4.9, you can record EMG as event related (as always) where a short duration of the EMG can be recorded and associated with each sample. You can now record continuous EMG as well, where one or both channels can be recorded for the entire duration of the study.

To set up the EMG options:

- **Double-check that you have selected the correct amplifier model in the preferences.** Brainsight currently supports 3 models, with model 1 and models 2 & 3 having different gain values so selecting the wrong one will result in incorrect EMG magnitude data. See “Setting your Preferences” on page 42 for details.
- Enable the recording of the Live EMG (both channels) by enabling the checkbox.
- Enable one or both channels using the checkbox next to each channel. Note that you can use either channel or both, and as described on page 130, you can enable either or both EMG channels in a second window while tracking two coils. This allows

you, for example, to track two coils at the same time, and have one or both EMGs associated with one coil's samples or the other.

- Set the baseline (time prior to the stimulator trigger) and trial (time after the trigger) durations for recording. The baseline value is negative to represent time before the trigger (which is the 0 time). The maximum range for the EMG recording is -100 ms to 250 ms and the minimum is -100 ms to 1200 ms.



• **NOTE:** The built-in EMG device is designed specifically for recording motor evoked potentials

(MEPs). Its dynamic range is set to be able to visualize a 50 μ v signal (for motor threshold). Its maximum range is approximately 5 mv peak to peak.

- Set the live EMG baseline correction. It is usually easiest to simply click on **Auto compute** to have Brainsight calculate and set this value. This estimates the DC drift and subtracts it so the EMG waveform is better aligned in the vertical axis.

VERIFY PROPER POLARIS LOCATION

The next screen (after the target screen) is intended

to ensure that the Polaris is correctly connected to the computer and that it is correctly positioned to view the relevant trackers.

- Observe that a few seconds after the Polaris window opens, the Polaris will beep, and the red boxes describing the camera's field of view will change from red to blue. (If you have been using the Polaris, it may not have required a reset and the camera's field of view will already be blue).
- Make sure that the subject tracker (and any other tools in the field of view) is well within the boundary and that the tools you intend to use (as seen on the list) are present.
- Click **Next Step**.

Fig. 16-6

Polaris verification screen.

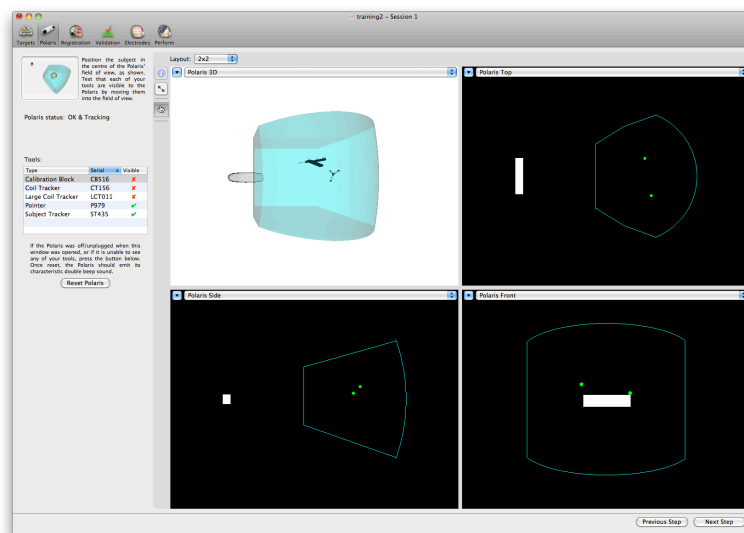

PERFORM THE SUBJECT-IMAGE REGISTRATION (SUBJECT-SPECIFIC IMAGES)

Recalling Chapter 14, you selected a series of anatomical landmarks on the images. In this step, you will identify those same landmarks on the subject's head using the tracked pointer. The software will use these point pairs to calculate the subject to image registration (Fig. 16-7). This step requires close interaction with the computer as you identify the points and "tell" the computer when you are pointing to the requested landmark. Make sure that the volume on the computer is high enough to hear the computer, as it will speak the names of the anatomical landmarks to identify. This step supports multiple input methods. Activate the voice recognition and/or the Apple

Fig. 16-7

Registration screen.

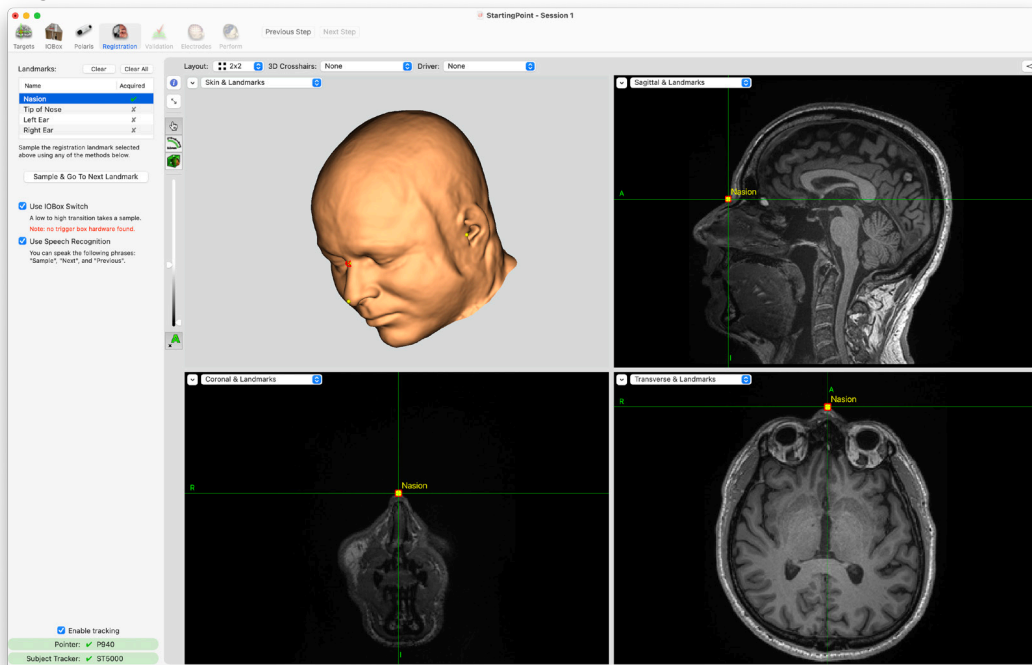

remote by enabling the appropriate checkboxes. Alternatively, have an assistant present to operate the computer for this step.

- Note the location of the cursor on the screen (or click on the first landmark to begin).
- Carefully place the pointer tip on the same landmark on the subject's head, being careful to gently touch the skin surface (do not "poke" the subject) and to keep the pointer still. Make sure both the pointer and subject tracker are visible to the Polaris by

making sure the boxes next to them in the window are green. If either the pointer or subject tracker are not visible, you will notice a red box around the image views.

- Have the computer sample that point by either pressing the foot switch, speaking the word "sample" to the computer (using the speech recognition), or by pressing the **Play** button on the Apple remote (if using the remote), or by clicking **Sample & Go To Next Landmark**. Note that the remote works best when not in the field of view of the position sensor camera,

What if my tools are not visible?

If you are placing your tools in front of the camera and they are not tracked, one of several events may have occurred. Before contacting Rogue Research, here are a few things to try/examine (we will ask this if you contact us):

- Does it only fail to track one tool? If so, examine the spheres for scratches or dirt and make sure they are all seated properly on the posts.
- Does it track better (all tools) close to the camera, but not near the rear of the field of view? Has this been getting worse over time? If so, your camera may need re-calibration (required every few years)
- Are there any reflective objects (mirrors, windows, reflective pane in the IR spectrum) facing the camera? This can blind the camera.
- Was it a sudden failure to track all tools? Was the camera dropped or bumped (the Vicra and Spectra have a bump sensor)? If so, it may require re-calibration or repair by Rogue Research.

or having the camera face the computer as the camera's IR output can interfere with the reception of the remote's signal.

- If you spoke the word sample, you should hear a "whit" sound. If not, try again (sometimes, saying "Simple" rather than "Sample" works). You can also change the command word in the preferences ("Setting your Preferences" on page 42). Regardless of the input method, you should hear a beep and notice a green check mark appear next to the landmark in the list. If not, repeat the voice command, or press the Apple remote again. If you hear an "error beep" (it sounds different, one that is universally recognized as a failure sound), the pointer and/or subject tracker were not visible. Make sure they are both visible and try again.
- Once you have sampled the point, it automatically goes to the next landmark and calls it out. Use the same technique to identify the landmark and have the computer sample the point.
- Repeat for all landmarks.
- You can repeat any point by either selecting it in the list (it will speak it out), or by speaking "previous" to the computer to change the current landmark to sample.
- Once all landmarks have been sampled, click on **Next Step**.

This step serves to verify and refine the quality of the

Fig. 16-8

Registration verification screen.

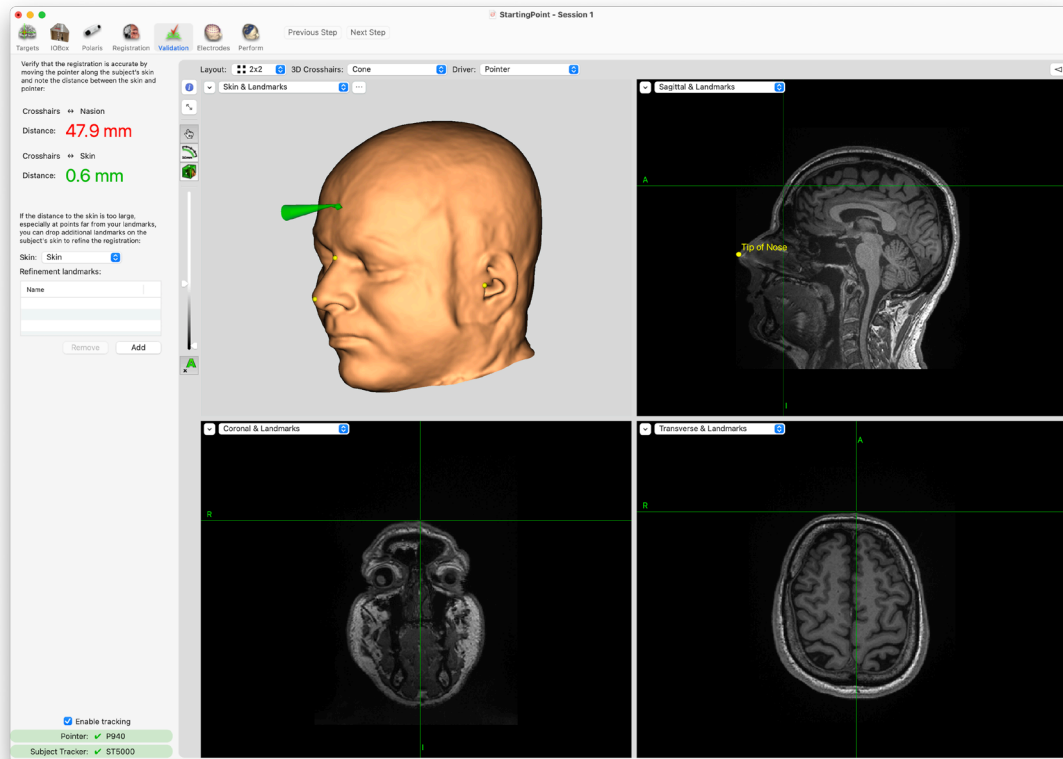

registration obtained from the previous step. The cursor will automatically move based on the location of the pointer on the head (the pointer is "driving" the cursor). You have the option of recording additional refinement points along the skin to attempt to improve the registration where the error is relatively small. While

this can improve the registration in certain cases, it is no substitute for acquiring good quality points in the first step. In the long run, a good registration can be achieved a lot faster by paying attention during the previous step.

- Move the cursor to various locations on the scalp and observe the location of the pointer on the screen

(Fig. 16-8). Make sure that the pointer is shown on the scalp at the same location as that of the pointer. There will always be some level of registration error. Note the distance from the pointer to the skin (assuming you performed a 3D skin reconstruction) by looking at the number in the **Crosshairs->Skin** display on the left of verification window. If the error value is consistently below 3 mm, it should be considered an excellent registration (the number is shown in green). Below 5 mm is often acceptable (shown in orange), particularly if it is below 3 mm near your target, and 5 mm elsewhere.

- If the pointer is between 3 & 5mm from the skin, try adding refinement points by holding the pointer on the skin, being careful not to push into the skin, and create a sample by clicking **Add** or using the same method as in the previous step (e.g., foot switch or voice command). Repeat this for several points in the area where the error was observed. Notice that the error should reduce as you add points.
- Always go back and examine the rest of the head after adding refinement landmarks as they have a global effect on the registration. In some cases, the correction in one area may cause a larger error in others.
- Distances larger than 5mm are shown in red as a reminder that a better registration should be attempted (you decide based on your requirements what is actually acceptable and the colours are

suggestions).

- If the registration is not acceptable, click **Previous Step** to repeat the registration. Otherwise, click **Next Step**.

The next step will be the EEG electrode recording step. It is becoming more common to combine EEG and TMS, either to measure changes in brain activity from the stimulation, or in closed-loop applications where the brain's waveform patterns (e.g. phase) are used to gate the TMS pulses. Refer to "Chapter 20: Special Application-EEG Recording" on page 168 for details on how to perform this step.

PERFORM REGISTRATION USING THE MNI MODEL HEAD PROJECT

If your project is based on the MNI model head template, then the registration procedure is a little different. The first step will consist of identifying three landmarks on the skin (the nasion, left & right ears) and the second step will be to record multiple landmarks on the scalp (the extremities) to help Brainsight measure the height, width and length of the subject's head to calculate an additional scaling to help better match the model head to the individual's head.

In this first step, you will identify those same landmarks on the subject's head using the tracked pointer. The software will use these point pairs to calculate the subject to image registration (Fig. 16-9A). This step requires close interaction with the computer as you identify the

points and "tell" the computer when you are pointing to the requested landmark. Make sure that the volume on the computer is high enough to hear the computer, as it will speak the names of the anatomical landmarks to identify. This step supports multiple input methods. Activate the voice recognition and/or the Apple remote by enabling the appropriate checkboxes. Alternatively, have an assistant present to operate the computer for this step.

- Note the location of the cursor on the screen (or click on the first landmark to begin).
- Carefully place the pointer tip on the same landmark on the subject's head, being careful to gently touch the skin surface (do not "poke" the subject) and to keep the pointer still. Make sure both the pointer and subject tracker are visible to the Polaris by making sure the boxes next to them in the window are green.
- Have the computer sample that point by either pressing the foot switch, speaking the word "sample" to the computer (using the speech recognition), or by pressing the **Play** button on the Apple remote (if using the remote), or by clicking **Sample & Go To Next Landmark**. Note that the remote works best when not in the field of view of the position sensor camera, or having the camera face the computer as the camera's IR output can interfere with the reception of the remote's signal.
- If you spoke the word sample (and you are using

OS 10.9), you should hear a “whit” sound. If not, try again (sometimes, saying “Simple” rather than “Sample” works). Regardless of the input method, you should hear a beep and notice a green check mark appear next to the landmark in the list. If not, repeat the voice command, or press the Apple remote again. If you hear an “error beep” (it sounds different, one that is universally recognized as a failure sound), the pointer and/or subject tracker were not visible. Make sure they are both visible and try again.

- Once you have sampled the point, it automatically goes to the next landmark and calls it out. Use the same technique to identify the landmark and have the computer sample the point.
- Repeat for all landmarks.
- You can repeat any point by either selecting it in the list (it will speak it out), or by speaking “previous” to the computer to change the current landmark to sample.
- Once all landmarks have been sampled, click on **Next Step**.
- Record landmarks on the top of the head by gently touching the top of the head with the pointer and clicking Add Landmark (Fig. 16-9B). Drop several landmarks so Brainsight can use the topmost of these for the scaling calculation (and you do not need to be very precise since there will be multiple

Fig. 16-9

A: Anatomical Landmark Identification

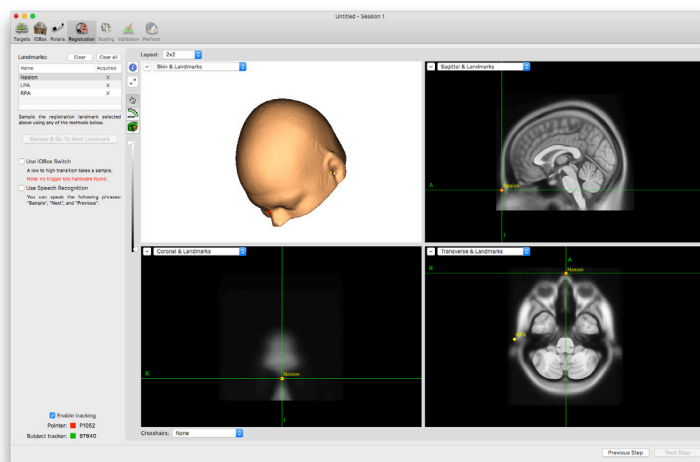

B: Scaling Landmark Recording

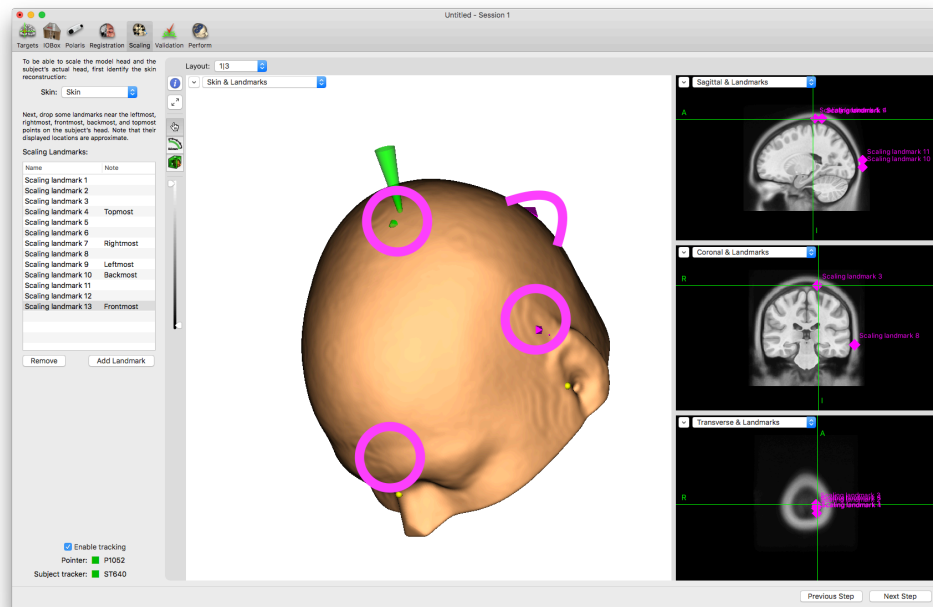

landmarks to choose from).

- Repeat this for the left, right front and back of the head.
- Look at the list of landmarks and note that Brain-sight has automatically selected and labelled the best landmarks as Frontmost, Backmost, Topmost, Leftmost and Rightmost. Click Next Step.

The final step is to verify that the registration was successful. Move the pointer on the head (Fig. 16-10), focusing on the same areas where the scaling landmarks were dropped in the previous step. Observe the numerical error displayed on the left of the screen (Crosshairs->Skin). It should be consistently at or below 3-4mm. Note that the error between these locations may be significantly higher. This is due to possible differences in curvature of the head shapes.

EEG ELECTRODE RECORDING

One technique that is becoming more common is to record EEG during the stimulation session. Another trend in EEG is to use navigation either verify correct placement of the EEG electrodes or to digitize the electrodes and export them in a coordinate system linked to the subject's MR images for more elaborate source localization. Brainsight has had this functionality for some time (see "Special Application-EEG Recording" on page 168) however it was not activated by default simply because it

Fig. 16-10

Verification of the registration. Note that the agreement should be best at the poles (top, front, back, left, right) and that there may still be disagreement between these locations.

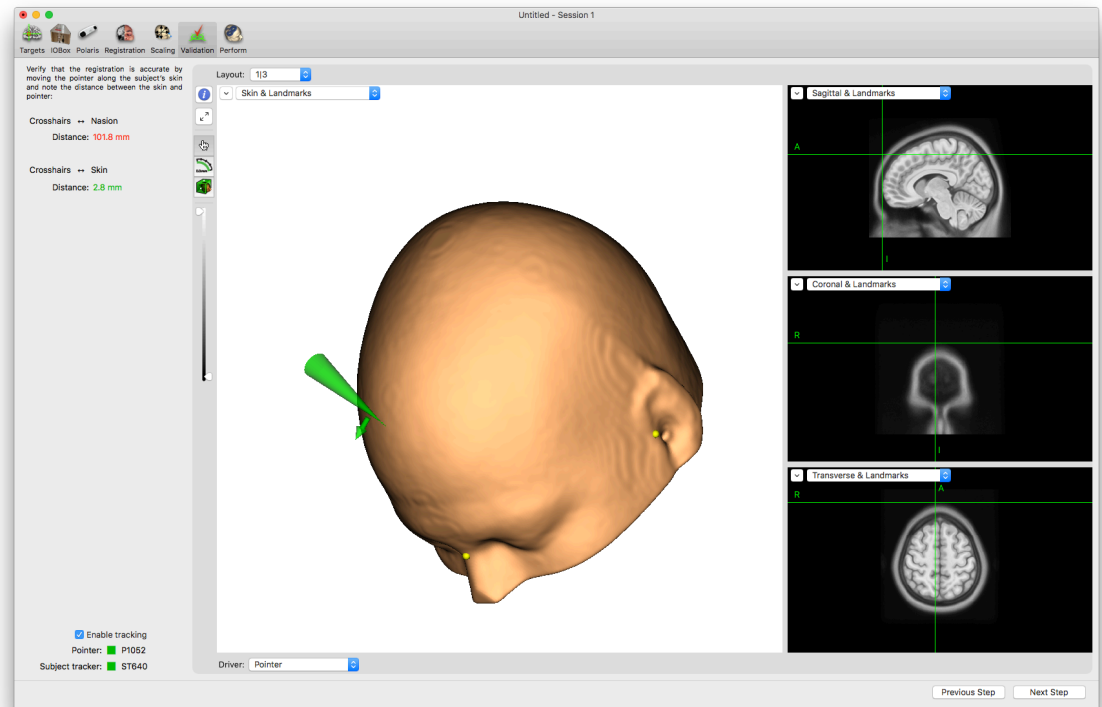

was not requested (and we try to balance simplicity of the user interface vs. the needed functionality). This step is now on by default.

The EEG step introduces another feature called the Cap Manager (Fig. 16-11). The cap manager allows you to define an EEG cap and keep it available for any subject. A cap definition consists of a list of electrodes (technically, they can be NIRS optodes as well) and optionally, their coordinates in the MNI coordinate space. Once defined, it can be applied to any subject MRI if the 3D skin was created and the MRI was co-registered to the MNI head using the Atlas step (“Chapter 10: MNI/Talairach Registration”). New caps can be created by reading them from a text file (contact Rogue Research for commonly used EEG cap layouts) or a cap can be digitized on a subject’s head and saved to the cap layout manager in MNI coordinates for use on other subjects.

Open the cap layout manager by selecting the **Window->Cap Layouts** menu (do this prior to the stimulation session so the caps are available now during the session). Add a cap from file by clicking **New->From File...** and selecting the layout file. A new blank layout can be created by clicking **New->Empty Layout** and giving it a name. New electrodes are added by clicking **Add**, and entering a name and optionally the MNI coordinates. Selecting one or more electrodes and clicking **Remove** deletes them from the list.

Fig. 16-12 shows the Electrodes step. To add a cap from the cap layout manager, click Add From...->Cap Layout...

and the selector pane will appear (Fig. 16-13). Select the cap from the cap list and if the cap has electrodes with MNI coordinates, select the MNI registration (the first one will be picked by default) and select Snap To->Skin (or the name of the 3D skin object you may have created). When you click OK, each the location of each electrode will be converted from MNI to the subject-specific MRI location and a second refinement will be performed to locate the nearest point on the “snap to” surface (skin), and the electrode will be placed there.

The additional “snap to” step is to ensure that despite any small MNI->Subject registration error, the electrode will always land on the skin (if it landed just under the scalp, you would not be able to see it). Note that the method to project from the MNI head to the subject head is a 3D transformation based on the image->image transformation. This does not capture the non-linear nature of the stretching of the EEG cap from its natural shape to the individual subject’s head (typical EEG caps were modelled on a head with a different profile than the MNI head). Some error in the predicted locations is inevitable, but will be close enough to put the locations of the electrodes where you would expect them.

Before digitizing the electrodes, click **Snap to->Skin** to ensure that when digitizing an electrode with the pointer, the location of the pointer is automatically projected to the closest location on the scalp (to compensate for the electrode thickness).

To digitize the electrodes:

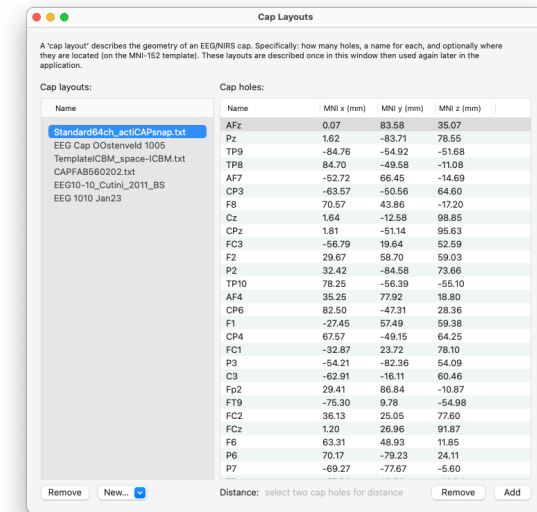

Fig. 16-11

Cap Layout Manager

- Select the first one in the list (or click on one in the 3D view) and note the computer will call out the name verbally (assuming the computer has a speaker output). Place the pointer over the top of the electrode closest to the middle of the electrode and either click Sample & Go To Next, or use the foot switch or speech recognition (described in the next section).

Note the sound confirming the successful sample,

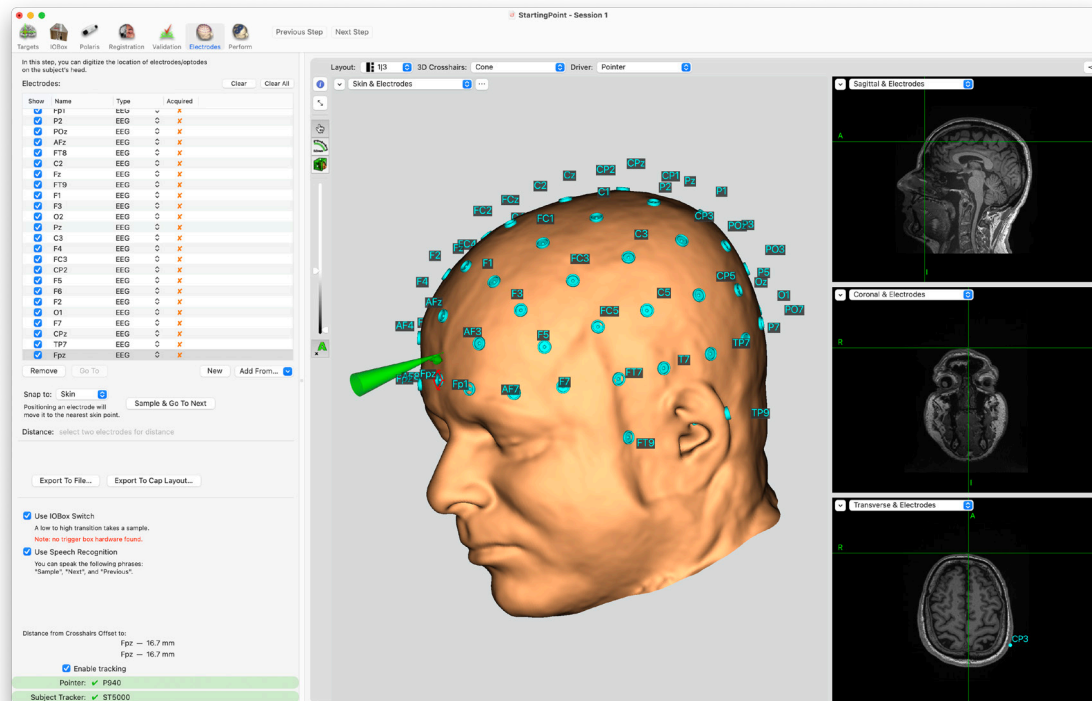

Fig. 16-12
EEG Step Window

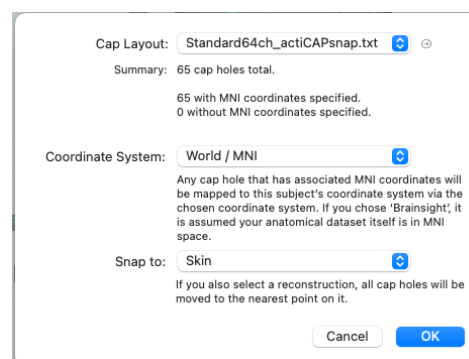

Fig. 16-13
Cap Layout selector pane

the “Acquired” indicator associated with the electrode in the list will change from an orange X to a green ✓, the location of the electrode will move to the sampled location and note the computer will select the next electrode on the list and verbally call it out.

- Continue to sample all the electrodes.
- If you do not have a cap layout file (so there are no electrodes in the list), then place the pointer on the electrode and click **New** to create a new electrode, then optionally change the name from the default value to the correct name. Point each successive electrode and click **New** to digitize it.

In addition to storing the electrode locations as part of the Brainsight project, you can export them into a variety of formats for use by external software.

- Click **Export to File...**, select the format from the list as well as the coordinate system, and provide a file name.
- If this cap was a new cap, it can also be stored in the cap manager for future use. Click Export to Cap Layout, enter a name and select the coordinate system. If you intend to use this cap on different subjects, select the MNI coordinate space so it can later be transformed from MNI to any other subject.

PERFORM THE STIMULATION SESSION

The next screen (Fig. 16-14) is optimized for the final step: placing the coil over your target. You should see

multiple 2D views, a 3D curvilinear brain and a bull's-eye view.

New controls in the perform window

In addition to the controls introduced in previous chapters, the session perform window adds a few new ones.

The crosshairs **driver** popup menu allows you to select which tool is linked to (or driving) the crosshairs. You can select from mouse (so you can move the cursor by clicking in any view as usual) or you can select the pointer or any valid coil calibration. Once you select a coil, placing the coil within the field of view of the position sensor camera will make the cursor move.

If you placed EEG electrodes (and/or NIRS optodes) in the Electrodes step, you can toggle their visibility here as well using the **Electrodes** popup menu.

As described in the targeting chapter, you can select the visual representation of the cursor for the 3D views using the **Crosshairs** popup menu.

When tracking a tool (pointer, coil, fUS transducer), it is important that the trackers be visible to the position sensor and important that you be aware that they are visible (or not!). When the subject tracker or the selected tool are visible, the box under each tracker (bottom left of the window) will appear green. When either one is not visible by the camera, the box under the tracker name will turn red. In addition, the frame around the entire image view section of the perform window will also

turn red (note in Fig. 16-14), there is a partial red line to indicate where the red frame will be but the entire frame will be red in actuality). Additionally, new samples will not be acquired as we cannot associate a valid tool location (better to not record it than record it incorrectly).

You can stream data in real time to a text file during the session, This includes the location of visible trackers, details about newly acquired samples as well as EMG. While it is being written to a text file, another program (e.g. Matlab or custom Python script) can read the same file at the same time and thus monitor this information during the session. The format is based on the format of the session export files (see "Exported Data Format" on page 177) has been quickly evolving, so the best way to understand the format is to review that section and to generate sample data by using the stream output directly. To enable the output, click **Stream To File...**, and navigate to the desired folder and enter a name.

Optimizing the view geometry

Brainsight configures the image view window according to the task currently being performed. In many cases, these are configured according to how we think it would be the most useful to you. The layout can be changed by selecting a new one from the Layout popup menu at the top of the window. Fig. 16-15 provides an example of a layout with one main view and 3 smaller complimentary views (1|3). Take some time to explore the options to find what you like best.

Note: The default representation of the crosshairs (and coil position when the coil is the active cursor crosshairs driver) in the 3D view is, as it has been in previous steps, a cone, or mini TMS coil. To augment this with a "realistic" graphical version of the coil: Click on the View Selector popup menu, and select "**Customize...**" to open the view configuration tool (Fig. 9-8 on page 68). Click on the "Accessories" button and select the coil representation you want to be displayed in the view. Close the window by clicking on the close button (the top left button of the window).

Setting user-trigger preferences

When placing the coil and throughout the session, it may be desirable to record the coil's position and orientation at certain times other than when the coil is fired (which is configured during the I/O box step. Note that if you are acquiring EMG, this can only occur when a TTL trigger is received as it is required to synchronize the EMG with the TMS pulse.

Each of these snippets of information recorded is referred to as a **sample**. Click **Trigger Options...** to open the options window (Fig. 16-16).

- During the TMS session, you may wish to record the coil location manually. You can always do so by pressing the **Sample** button, but you can also do so remotely using switch input (e.g. foot or hand-held switch) or voice recognition by enabling their respective check boxes.
- When recording the coil location, you may encounter

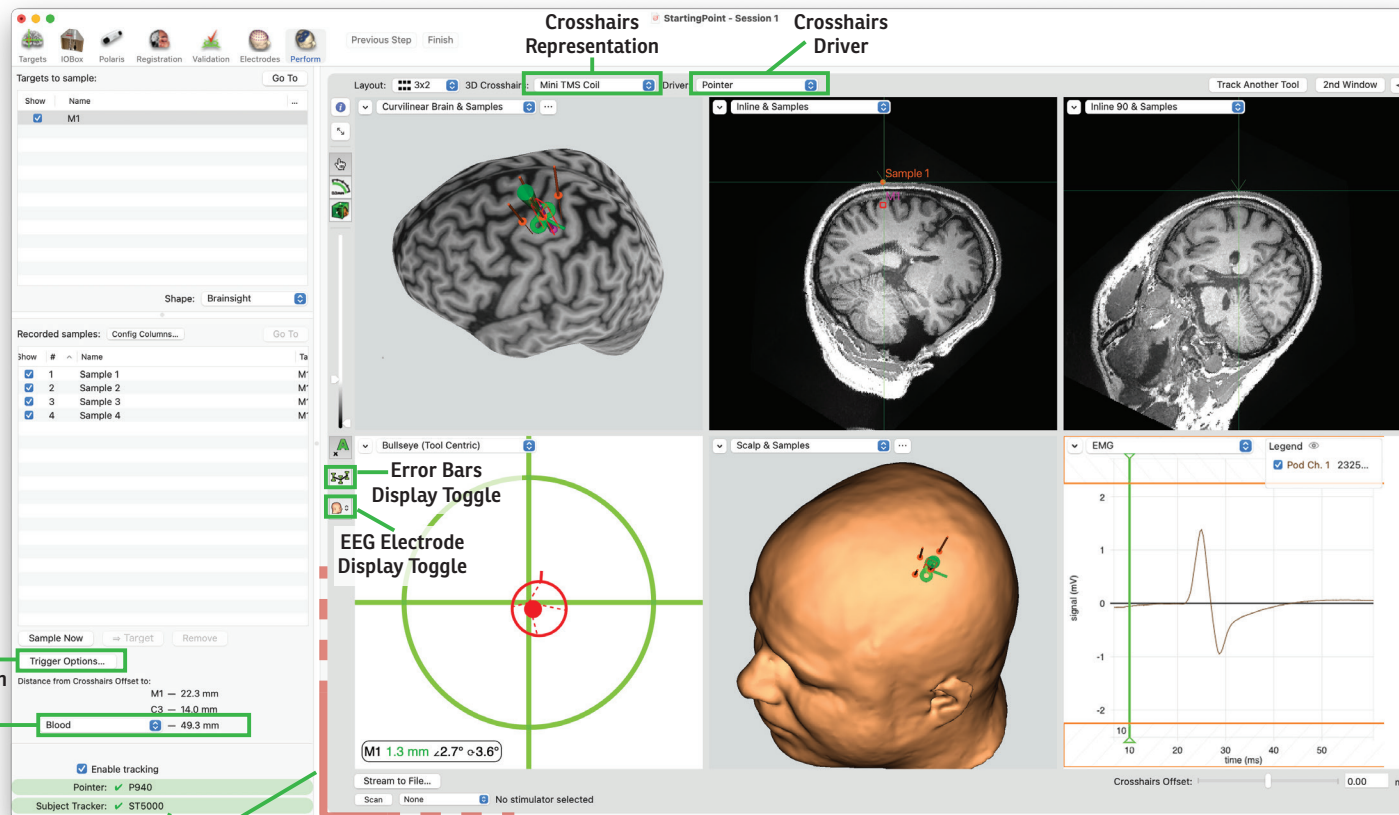

Trigger Configuration
Distance to Surface

Tool Visibility Indicators

Fig. 16-14
Typical Perform Session view window.

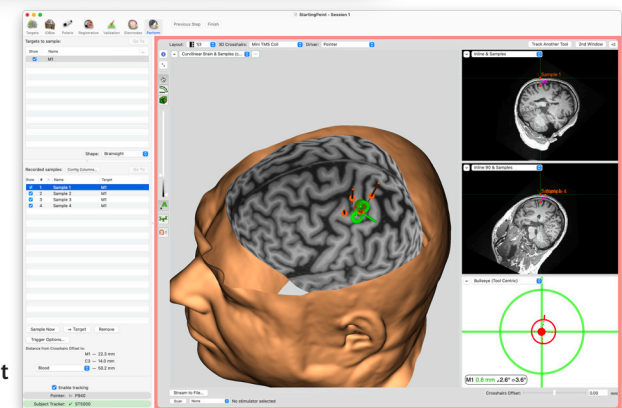
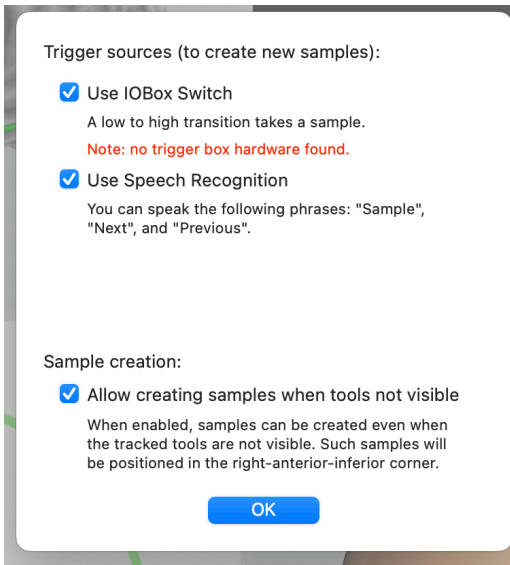

Fig. 16-15
Another example of a window layout effective for coil positioning.

Fig. 16-16

Trigger Options Window



a situation where the coil tracker is not visible when acquiring the sample. You may either want to prevent a sample from being acquired (so you do not record the coil in an incorrect location), or, for example, you are acquiring data from multiple devices and it is important to keep them synchronized by having the same number of samples, choose your preference with the **Sample creation** checkbox.

- Close the window by clicking **OK**.

Visualizing and recording EMG

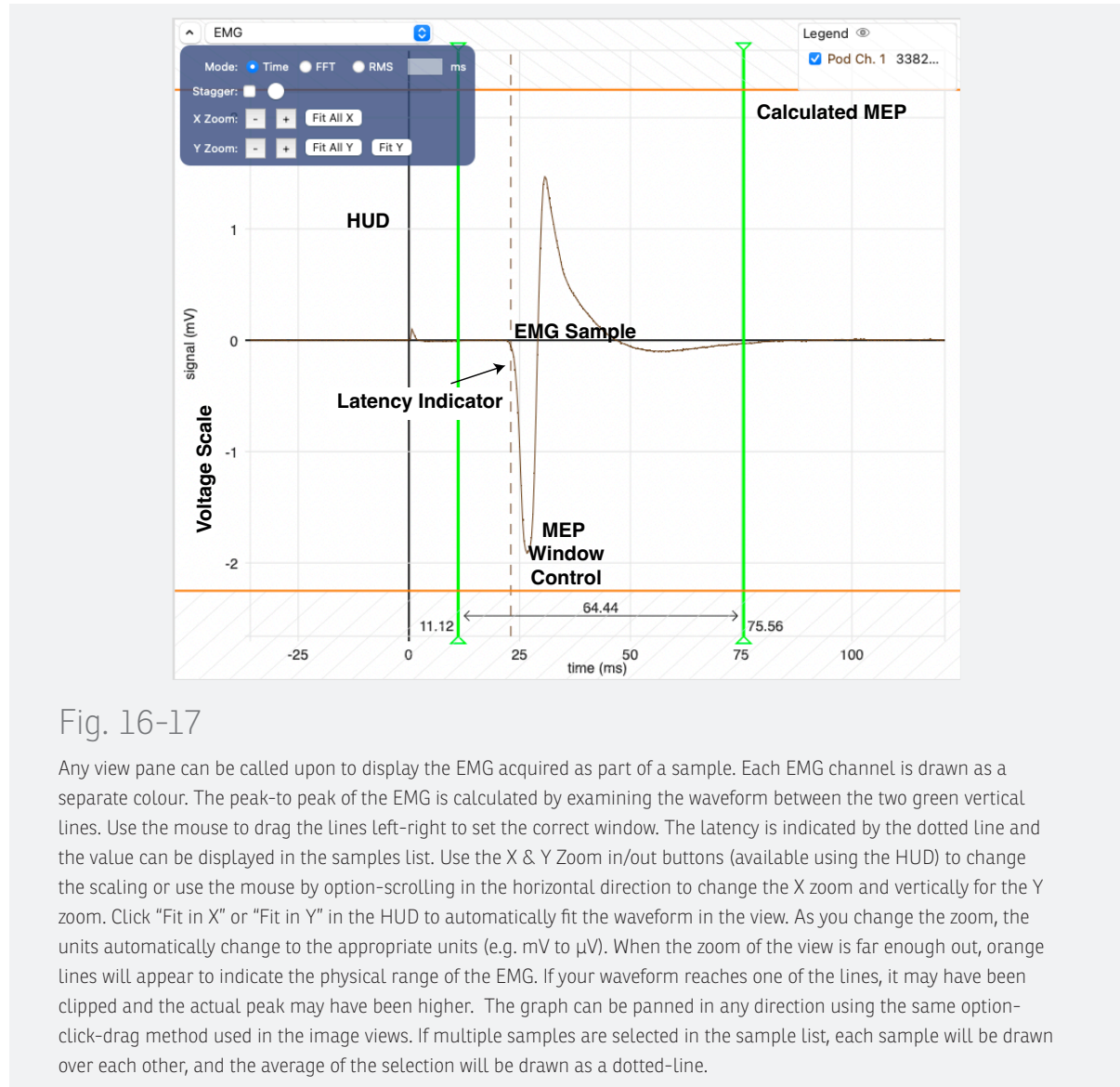

Fig. 16-17

Any view pane can be called upon to display the EMG acquired as part of a sample. Each EMG channel is drawn as a separate colour. The peak-to-peak of the EMG is calculated by examining the waveform between the two green vertical lines. Use the mouse to drag the lines left-right to set the correct window. The latency is indicated by the dotted line and the value can be displayed in the samples list. Use the X & Y Zoom in/out buttons (available using the HUD) to change the scaling or use the mouse by option-scrolling in the horizontal direction to change the X zoom and vertically for the Y zoom. Click "Fit in X" or "Fit in Y" in the HUD to automatically fit the waveform in the view. As you change the zoom, the units automatically change to the appropriate units (e.g. mV to μ V). When the zoom of the view is far enough out, orange lines will appear to indicate the physical range of the EMG. If your waveform reaches one of the lines, it may have been clipped and the actual peak may have been higher. The graph can be panned in any direction using the same option-click-drag method used in the image views. If multiple samples are selected in the sample list, each sample will be drawn over each other, and the average of the selection will be drawn as a dotted-line.

Fig. 16-18

Bull's-eye display.

Interpreting the bull's-eye display

The bullseye view is a simple way to visualize the position and orientation of the coil w.r.t. the target. There are two versions of the bullseye display with two perspectives. The first one orients the display from the coil's perspective. That means that the coil remains at the centre of the image view and the target moves on the screen when the coil is moved (since the coil is the fixed reference frame). The second version of the display is from the target's perspective. In this view, the coil moves and the target is locked to the centre of the display and the task is to get the coil centred on the target.

In both modes, the numerical display at the bottom left indicates the targeting error and angular error, which is the distance from the target to the closest point along the line projecting from the coil's reference point into the head (along the coil's trajectory) and the angle of the coil with regards to the target trajectory angle. In general, a value of 1mm or less should be considered very good.

Note that when using scalp-based targets, our metaphor of the target and scalp entry point breaks down. In this case, the circle will not move once the coil is on the correct scalp location (since the target is on the scalp) but the circle will move when the angle of the coil changes, so in the end, you still want the circle and dot in the middle, just align the dot first, then the circle.

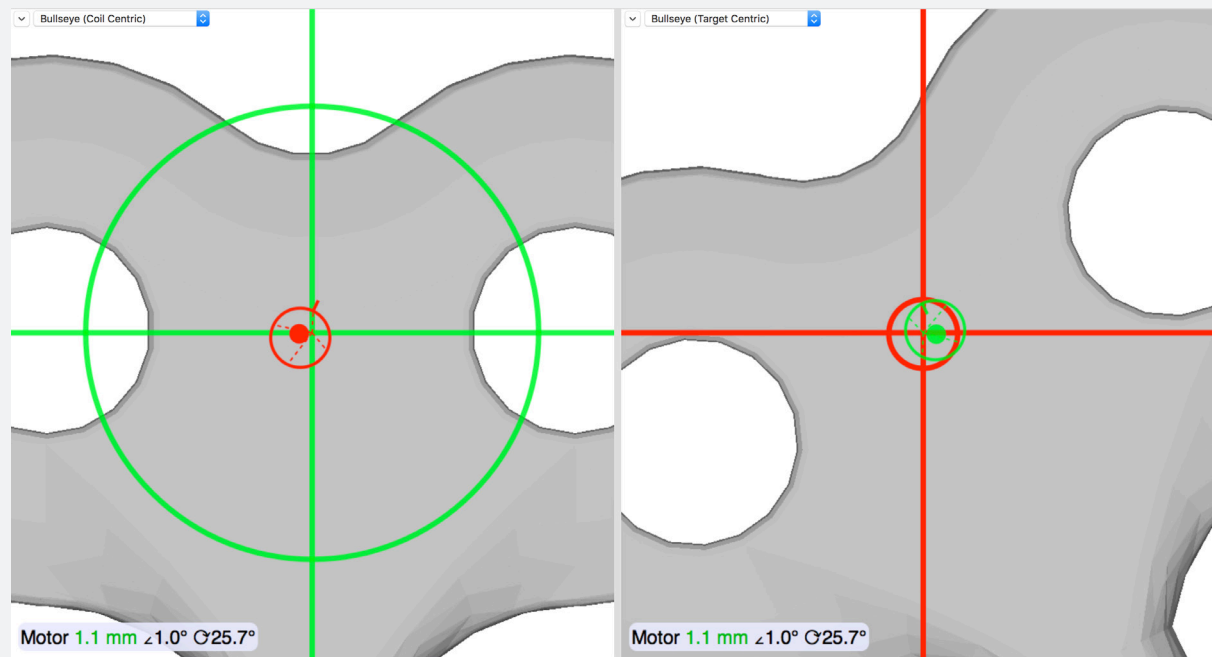

If you activated the EMG in the I/O box step, then you can visualize the EMG in any view pane, by selecting it from the view selector list of any view pane. Fig. 16-17 describes the EMG samples view.

In addition to the EMG recorded for each sample, you can also display the live EMG by selecting Live EMG in the view pane selector.

Now You Can Stimulate...

- Select the desired target by clicking on it in the list of targets, or if the voice commands have been activated, by saying the "next" or "previous" commands to cycle to the target in the list.
- Select your coil as the input from the Crosshairs popup near the bottom left of the image views (recall Fig. 16-14).
- Move the coil on the head, observing the views on the screen. Many users have different preferences regarding how they use the views to place the coil. In general, the 3D views serve to help you get the coil close to the target. Once close, use the inline and inline-90 views to ensure that the coil's orientation is normal to the brain surface and use the bull's-eye to ensure that the coil is pointing to the target.
- If you are using the bull's-eye view, you can also note the targeting error on the bottom-left of the view. This number represents the shortest distance from the target to the vector projecting from the

coil's reference spot along the coil's trajectory (think of it as how far off a dart ends up from the center on a dart board). A value of 0 means that the coil is pointing directly at the target. Note that in practice, a value of 0 is not realistically achievable and you should decide what is an acceptable value (e.g. 1 to 1.5 mm). Note that the value will fluctuate continuously even if the coil and head are completely still, which is due to the normal fluctuation of the position sensor measurement of the tracker spheres.

- When using the bull's-eye display for trajectories, the easiest way to use it is to break up the task into two steps. First, move the coil over the scalp until the red circle is centered. The red circle can be thought of as the scalp entry point. Next, tilt the coil until the red dot is in the middle. The red dot represents the target in relation to the projection of the coil. If the red dot is in the middle of the green cross hair, it means that the coil is pointing towards the target (regardless of the trajectory). Note that this metaphor is less helpful for trajectories whose origin is in the scalp as the scalp entry point and target is the same place. In this case, the best use of the bull's-eye is in reverse. Move the coil so that the dot is centered (the coil is on the correct scalp location) and tilt the coil to get the circle in the middle (setting the angle).
- The real distance from the coil face to the current target and the closest targets are displayed on the

bottom left of the window.

- If you wish to record locations within the cortex (instead of on the surface), add an offset to the coil location by sliding the offset slider (next to the crosshairs input) to the right. This offset is added to the coil location in the direction along the coil path, or in the case of the pointer, projected along the shaft into the head. Typically, 15 mm will place the cursor origin inside the cortex. The coil, as seen in the 3D view, will appear in the correct location, however the cursor will be projected into the head. This technique is particularly useful if you intend to use recorded coil orientations as targets for subsequent sessions as the bull's eye view works better when the target and scalp entry point are not the same point.
- Record the coil position and orientation by clicking Sample Now, or speaking the "sample" command. If your computer is connected to the TMS stimulator via a compatible LabJack interface (or you have a recent Brainsight computer/trolley with the trigger input), the sample will be recorded automatically when the coil is fired.
- Once your TMS study has been completed, save the acquired data by selecting File->Save Project.

TRACKING A SECOND COIL SIMULTANEOUSLY

In certain TMS studies, it is becoming more common to use two coils to perform simultaneous or near

simultaneous stimulation on two sites. Brainsight allows you to track both coils at the same time, provided you have a second coil tracker (contact Rogue Research for more details). If you have the TTL trigger box (either the standalone unit, or the I/O box as part of our computer trolley), you can trigger the recording of each coil individually as well.

To track two coils, before starting a TMS session:

- If you have the required hardware for triggering from the TMS devices, connect the trigger out of TMS coil A into trigger in 1 on the Brainsight trigger box, and TMS coil B to trigger in 2.
- Attach a tracker to each coil.
- Follow the steps in Chapter 7 twice, once for each coil.
- Follow the instructions in this chapter to start a TMS session until you have performed the image-subject registration.
- Set the TTL trigger in to use trigger 1.
- Click **Track another coil**. A second view window will open.
- Set the trigger options to use TTL trigger 2 of the I/O box. Note that you can only use the voice recognition and/or Apple remote for one window at one time.
- When you are ready to track the coils, set the crosshair input of one window to the coil that is triggering the samples, and the input of the second

window to the other coil.

- Place your coils and stimulate. Each time one coil is fired, the corresponding window will record the coil location.
- When the experiment is finished, close the two windows. Note that each window will be stored as a separate session.

OPENING A SECOND VIEW WINDOW (ONE COIL)

In certain cases, there may be more information that you wish to monitor than can be adequately displayed in one window. If your computer is equipped with a second monitor, you can open a second image view window and display additional information. For example, if you are performing complex EMG related experiments, it may be useful to open a second window and set the layout to 2x1 and display the live EMG in one image view and the event related EMG in the other.



Chapter 17: Special Application: Network Interface

Neuroscience and the equipment and techniques to perform neuroscience research has evolved over the years. Some of these trends have involved using real-time data acquisition to make decisions on how the experiment should proceed. These can simply using the MEP to automate motor threshold determination or using changes in EEG to confirm target engagement.

With the introduction of our Elevate TMS and associated robot, the possibilities to control all these devices to explore more complex parameter spaces represent an exciting prospect for research and potentially in future clinical applications.

Brainsight enables this new field of research by introducing a bi-directional TCP interface. This allows you to write your own program to receive real-time tool position information as well as EMG (from our EMG or the NeuroPRAX EEG) and control Brainsight to create and/or set targets and send the robot there under your command.

INTRODUCTION

A typical setup (Fig. 17-1) for this type of experiment would require the navigator computer, the TMS device, the robot (if present) and potentially any other data acquisition device specific to your experiment. It also includes your control program, typically written in Python or Matlab (or any other language that supports TCP connections) running on a dedicated computer or sharing the navigation computer (if fast enough). Our latest navigator computer trolley includes an integrated Ethernet hub with built-in DHCP server to make interconnection simple. The hub contains a WAN port to enable connection an external network allowing each device to access the external network as well as each other in the local network defined by the router.

The Brainsight navigator manages the status and operation of itself, the integrated EMG (or neuroPRAX EEG if present) and optionally the robot, so the single connection from your program to Brainsight means access to Brainsight, EMG data and controlling the robot via Brainsight. This ensures that only commands that the robot can carry out successfully will be accepted and implemented and you do not need to worry about the robot kinematics or dealing with head tracking.

Your program would connect directly to other devices (e.g, TMS, fUS, EEG etc...) and manage them directly. This gives you the possibility of using any sensor data to make decisions about the execution of the experiment. For example, you may be interested in implementing a

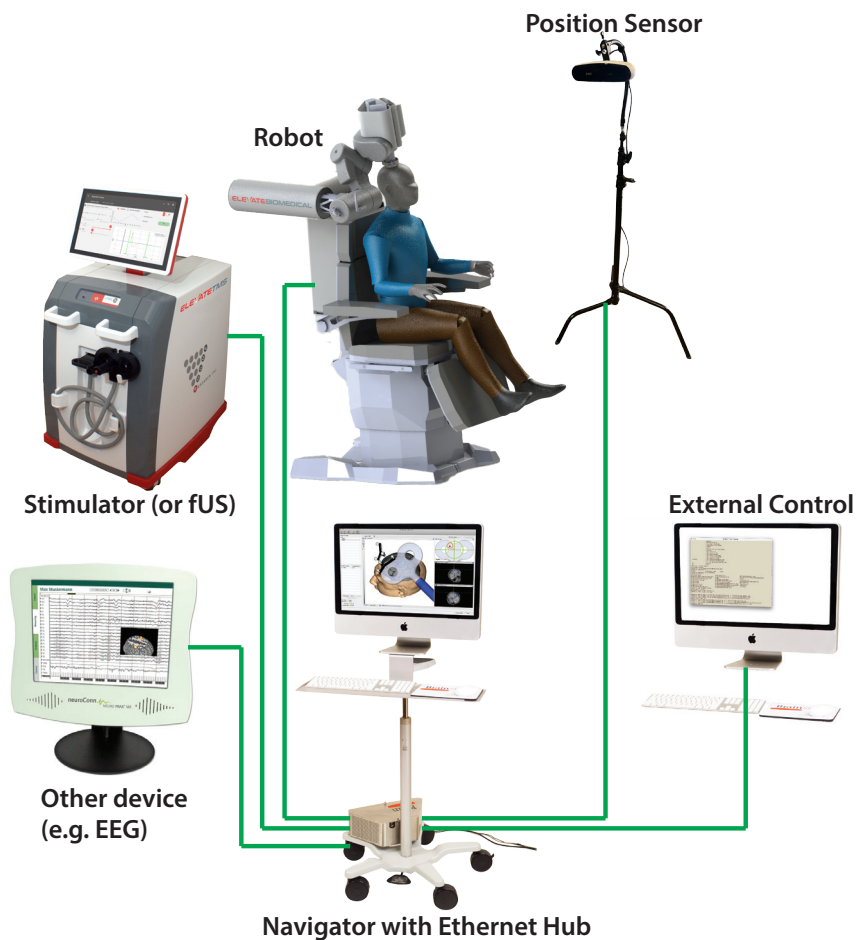

Fig. 17-1

Typical configuration for a real-time experiment control.

specific search algorithm that uses EEG or EMG data from a TMS pulse to decide on the location and nature of the next pulse.

We encourage you to contact us with your experiment ideas to help you implement them as well as help us decide on how to expand these capabilities to meet your needs.

ACTIVATING AND CONNECTING

To activate the network server, select **Window->Network Server Configuration** and a new window will open (Fig. 17-2). Click **Start Network Server** and Brainsight will now be ready to accept connections. Note that this initial implementation does not include password protection, so it is advisable to use the local network to connect your devices to provide physical control over the devices have on the network.

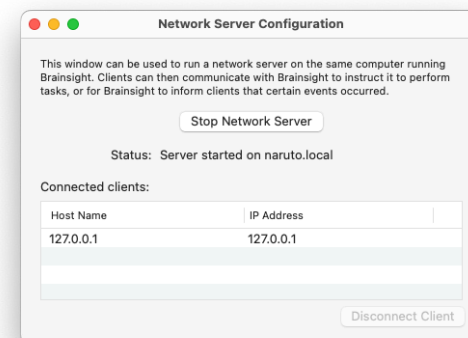

Fig. 17-2

Network server window.

Your external software can initiate a connection using the protocol defined in the next section. When a connection is established, it will appear in the Connected clients list. You can stop the connection at any time by clicking **Stop Network Server** at any time.

Your external program can initiate a connection and then send requests for information on a one command-one response strategy, or request that data be streamed continuously. is an example of such a program. Contact us to obtain a copy of this program (and we are developing more examples). We will be setting up a server to make these examples more widely available.

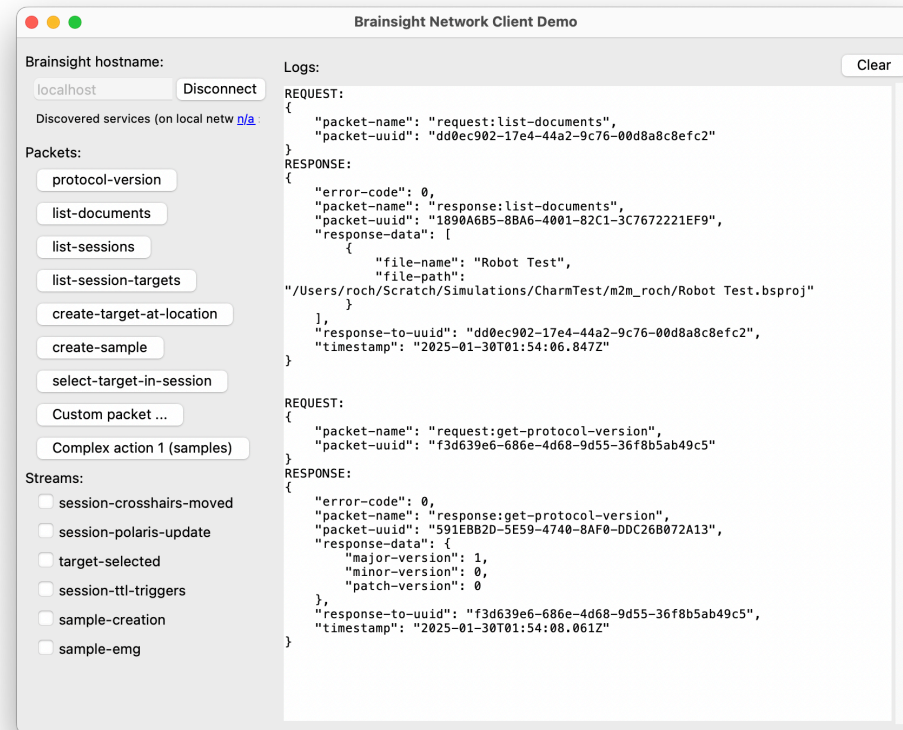

Fig. 17-3

Example program in Python that connects to Brainsight and can send commands and display the results. Note the json structure of the requests and response.

PROTOCOL

Brainsight Network Server Protocol

Overview

This network protocol allows you to instruct Brainsight to perform various tasks and allows Brainsight to inform you when various events have occurred.

You can instruct Brainsight to:

- list all open documents
- list all open sessions
- list all targets in the active session
- create a target in the active session
- create a sample in the active session
- change the target selection in the active session

And Brainsight can inform you when:

- the active session's crosshairs coordinate changes
- the active session's selected target changes
- a sample is created in the active session
- EMG data is received for a newly created sample
- the Polaris camera updates with new tool positions
- an IOBox TTL trigger occurs

The former group are explicit commands that you give to Brainsight, while the latter group Brainsight sends to you as soon as they occur (you must opt-in to receive these).

Example code

We provide a Python library to handle the low-level

networking details, and a sample Python application illustrating its use. Alternatively, you can use the information in this document to implement the network protocol yourself in a different programming language.

Network Connection Overview

- All connections are with TCP over either IPv4 or IPv6 on port 60000.
- Brainsight acts as the server, your code is the client.
- Multiple clients can be connected simultaneously.
- Each client connects with a single socket.
- Brainsight advertises its availability using Bonjour (also known as mDNS).
- Clients can be running any operating system and programmed in any language.
- The network protocol is based on JSON, encoded as UTF-8.
- Each JSON packet is ended with the RS (record separator) character (ASCII 30 decimal, 0x1E hexadecimal).

Packet types:

1. **request:** Corresponds to a packet sent by the client to the server.
2. **response:** Corresponds to a packet sent by the server to the client pertaining to a previous **request** packet.
3. **stream:** Corresponds to live feedback sent from the server (not relating to any particular request) as a result of the user's interaction with Brainsight,

example: when the crosshairs are moved the updated position is streamed to the client as feedback **stream:session-crosshairs-moved**.

4. **error:** Corresponds to a packet sent by the server to the client in response to a packet that was missing vital information or completely malformed.

Common for client to server packets

The following are some common keys that may/must exist in packets sent from a client to the server:

- **packet-name** (required, string) : corresponds to the request to be executed. This defines what other keys to expect in the dictionary. Must have the prefix **request:**.
- **packet-uuid** (required, string) : An identifier that will be returned back in response packets in the **response-to-uuid** field. This is highly suggested to be unique, like a UUID, so that it can be used for bookkeeping.

Common for server to client packets

The following are some common keys that may/must exist in packets sent from the server to a client:

- **packet-name** (required, string) : This defines what other keys to expect in the dictionary. Prefixed with **response:**, **response-delayed:**, or **stream:** for further elaboration of the nature of the packet.
- **packet-uuid** (required, string) : A UUID in string representation.

- **error-code** (required, integer) : Zero if the command being replied about was successful, non-zero if some error occurred. The non-zero value indicates what kind of error occurred. This field is suitable for parsing in code. See Appendix I for possible error codes.
- **error-message** (optional, string) : Not present if the command being replied about was successful, otherwise a human-readable English error message describing the reason for failure. This field is not suitable for parsing in code, it is there as an aid to a human reader.
- **response-to-uuid** (optional, string) : When a packet sent to Brainsight contained a **packet-uuid**, the response to that packet will have the same string passed back in this field.
- **timestamp** (required, string): A date and timestamp, intended for bookkeeping purposes. See Appendix II for format details.

Protocol commands

Setting stream options

This command allows turning on or off the various streaming options. By default, no streams are sent, you must turn on any you are interested in.

Request format:

- **packet-name** (required, string) : The string **request:set-stream-option**.
- **stream-name** (required, string) : The name of the

stream option to change. Must be one of:

- **stream:session-crosshairs-moved**
- **stream:target-selected**
- **stream:sample-creation**
- **stream:sample-emg**
- **stream:session-polaris-update**
- **stream:session-ttl-triggers**
- **stream-value** (required, boolean) : Whether the named stream option should be enabled or not.

Response format:

- **packet-name** (required, string) : The string **response:set-stream-option**.

Example request:

```
{
  "packet-name": "request:set-stream-option",
  "packet-uuid": "72EAD6AB-4E5F-4DE5-9348-7B7C3F1EDF2E",

  "stream-name": "stream:session-polaris-update",
  "stream-value": true,
}
```

Example response:

```
{
  "packet-name": "response:set-stream-option",

  "error-code": 0,
  "response-to-uuid": "72EAD6AB-4E5F-4DE5-9348-7B7C3F1EDF2E",
```

```
"packet-uuid": "31EDCFBB-21AD-4A53-8E8F-85F8F044D2EF"
}
```

Fetch Protocol Version

This command retrieves the current protocol version number. When backwards-incompatible changes are inevitably made, the major version number will be incremented. The minor and patch version numbers may be incremented when smaller backwards-compatible changes are made.

Request format:

- **packet-name** (required, string) : The string **request:get-protocol-version**.

Response format:

- **packet-name** (required, string) : The string **response:get-protocol-version**.
- **response-data** (required, dictionary) : Dictionary with the following keys:
 - **major-version** (required, integer) : The current protocol major version.
 - **minor-version** (required, integer) : The current protocol minor version.
 - **patch-version** (required, integer) : The current protocol patch version.

Example request:

```
{
  "packet-name": "request:get-protocol-version",
```

```
"packet-uuid": "2F2DA0F9-785B-41EA-B197-B3AF8A-
ECDA55"
}
```

Example response:

```
{
  "packet-name": "response:get-protocol-version",

  "response-data": {
    "major-version": 1,
    "minor-version": 0,
    "patch-version": 0
  },

  "error-code": 0,
  "response-to-uuid": "2F2DA0F9-785B-41EA-B197-
B3AF8AECDA55",
  "packet-uuid": "04C91186-0B70-4289-8768-789F62B-
FA55F",
  "timestamp": "2024-07-26T15:50:59.123Z"
}
```

Listing of project documents

This command lists all currently open project documents.

Request format:

- **packet-name** (required, string) : The string **request:list-documents**.

Response format:

- **packet-name** (required, string) : The string **response:list-documents**.
- **response-data** (required, array of dictionaries) : Array

of dictionaries with the following keys:

- **file-name** (required, string) : The name of the document, including the **.bsproj** file extension.
- **file-path** (optional, string) : The full path to the document on disk. If the document has never been saved, this will not be present.

Example request:

```
{
  "packet-name": "request:list-documents",

  "packet-uuid": "FCB16A8E-F170-4383-A74B-
75A9245F3689"
}
```

Example response:

```
{
  "packet-name": "response:list-documents",

  "response-data": [
    {
      "file-name": "Experimental.bsproj",
      "file-path": "/Users/brainsight/Documents/Experi-
mental.bsproj"
    }
  ],

  "error-code": 0,
  "response-to-uuid": "FCB16A8E-F170-4383-A74B-
75A9245F3689",
  "packet-uuid": "F3F3D1FF-71D7-4640-AF23-
```

```
BC385E134333",
  "timestamp": "2024-07-26T15:55:09.456Z"
}
```

Listing of sessions

This command lists all sessions present in the opened document.

Request format:

- **packet-name** (required, string) : The string **request:list-sessions**.

Response format:

- **packet-name** (required, string) : The string **response:list-sessions**.
- **response-data** (required, array of dictionaries) : Array of dictionaries with the following keys:
 - **uuid** (required, string) : The session's uuid, which uniquely identifies it amongst all Brainsight objects.
 - **name** (required, string) : The session's name.

The action may fail if:

- No document is opened. **kBSErrorCode_NoDocuments**.
- Multiple documents are opened. **kBSErrorCode_MoreThanOneDocument**.

The action will succeed only if exactly one document is open. If that one document has no sessions, the result will be an empty array and an **error-code** of 0.

Example request:

```
{
```

```

"packet-name": "request:list-sessions",

"packet-uuid": "2038BB78-A79A-4929-B262-
C67877100753"
}
Example response:
{
"packet-name": "response:list-sessions",

"response-data": [
  {
    "name": "Session 1",
    "uuid": "A2ECC95A-66E7-44F7-B8A6-
A770396903AC"
  }
],

"error-code": 0,
"response-to-uuid": "2038BB78-A79A-4929-B262-
C67877100753",
"packet-uuid": "67E37AB3-3FD2-42C2-AD05-5EA-
055B987A1",
"timestamp": "2024-07-26T16:18:03.789Z"
}

```

Listing of targets in the active session

This command lists all targets present in the active session. The list is sorted in the same order as in the session.

Request format:

- **packet-name** (required, string) : The string **request:list-session-targets**.
- **session-name** (optional, string) : The name of the session of interest, targets pertaining to it will be listed if the session is active. Generally not necessary because the currently active session is presumed. Only in the case of two simultaneous sessions (for tracking two TMS coils) must the session name be provided.

Response format:

- **packet-name** (required, string) : The string **response:list-session-targets**.
- **response-data** (required, array of dictionaries) : Array of dictionaries with the following keys:
 - **name** (required, string) : The name of the target.
 - **position** (optional, array of 16 floats) : The position of the target as a 4x4 matrix. See Appendix III for format details. For folders, this will not be present.
 - **coordinate-system** (optional, string) : The coordinate system of the position given. The coordinate system of the session's Perform step will be used. See Appendix III for details. For folders, this will not be present.
 - **index-path** (required, 0-based array of integers) : An array of 0-based integers that represent the path to the target in the list of targets of a session. For example, the array [0, 2] indicates that the target is the 3rd item [2] of the 1st folder [0].

- **uuid** (required, string) : The target's uuid, which uniquely identifies it amongst all Brainsight objects.

The action may fail if:

- No document is opened. **kBSErrorCode_NoDocuments**.
- No session with the given **session-name** is active. **kBSErrorCode_NoActiveSessionWithName**.
- The session window is open, but the perform step has not been activated. **kBSErrorCode_PerformStepNotLoaded**.
- No session is active. **kBSErrorCode_NoActiveSession**.

Example request:

```

{
"packet-name": "request:list-session-targets",
"session-name": "Session 1",
"packet-uuid": "02EDD26B-95D1-4319-BC1E-
2A978F2215E4"
}

```

Example response:

```

{
"packet-name": "response:list-session-targets",

"response-data": [
  {
    "index-path": [ 0, 2 ],
    "name": "Marker 1",
    "coordinate-system": "World",
    "position": [

```

```

    -0.6, -0.5, -0.4, 7.8,
    0.6, -0.7, -0.1, 18.5,
    -0.2, -0.4, 0.8, 10.8,
    0, 0, 0, 1
  ],
  "uuid": "7856B7EA-36F2-4CC9-9C41-
68E92F077BD6"
},
{
  "index-path": [ 1 ],
  "name": "Marker 2",
  "coordinate-system": "World",
  "position": [
    -0.7, -0.6, -0.9, 19.3,
    0.5, -0.6, -0.5, 82.9,
    0.2, -0.4, 0.8, 141.0,
    0, 0, 0, 1
  ],
  "uuid": "801CC810-C459-42F6-9D40-3F9D-
BB9E7D29"
}
],
"error-code": 0,
"response-to-uuid": "02EDD26B-95D1-4319-BC1E-
2A978F2215E4",
"packet-uuid": "A7F110F2-6399-4443-AE50-
4716200CCF52",
"timestamp": "2024-07-26T16:32:41.348Z"
}

```

Creating a target in the active session

This command creates a target at a specified location and adds it to the active session's list of targets (at the end of the list).

Request format:

- **packet-name** (required, string) : The string **request:create-target-at-location**.
- **name** (optional, string) : The name for the newly created target. Defaults to using Brainsight's naming convention if not provided (ex: **Marker 1** or **Trajectory 1**, etc.)
- **position** (required, array of 16 floats) : The position and orientation of the target as a 4x4 matrix. See Appendix III for format details. If unspecified, defaults to placing the target at the crosshairs position in the Session Perform window.
- **coordinate-system** (required, string) : The coordinate system of the position given. See Appendix III for details.
- **session-name** (optional, string) : The name of the session to add the target to. Generally not necessary because the currently active session is presumed. Only in the case of two simultaneous sessions (for tracking two TMS coils) must the session name be provided.

Response format:

- **packet-name** (required, string) : The string **response:create-target-at-location**.

- **response-data** (required, dictionary) : Dictionary of the created target's attributes as its keys. Note, the target will be added to the session.
- **index-path** (required, 0-based array of integers) : An array of 0-based integers that represent the path to the target in the list of targets of a session. For example, the array [0, 2] indicates that the target is the 3rd item **[2]** of the 1st folder **[0]**.
- **uuid** (required, string) : The target's uuid, which uniquely identifies it amongst all Brainsight objects.
- **name** (required, string) : The name of the target.
- **position** (required, array of 16 floats) : The position and orientation of the target as a 4x4 matrix. See Appendix III for format details.
- **coordinate-system** (required, string) : The coordinate system of the **position** returned. The coordinate system of the session's Perform step will be used. See Appendix III for details.

Prerequisites:

- Exactly one session must be opened (or in the case of two simultaneous sessions, for tracking two TMS coils, the session name must be provided).

The action may fail if:

- No document is opened. **KBSErrorCode_NoDocuments**.
- No session with the given **session-name** is active. **KBSErrorCode_NoActiveSessionWithName**.

- No session is active. **kBSErrorCode_NoActiveSession**.
- The session window is open, but the perform step has not been activated. **kBSErrorCode_PerformStep-NotLoaded**.
- The **position** has less or more than exactly 16 floats. **kBSErrorCode_MatrixSizeNot4x4**
- The **position** has non-finite or crazy values. **kBSErrorCode_CrazyFloatingPoint**
- The **position** is not an invertible matrix. **kBSErrorCode_NonInvertibleMatrix**
- The **position** is not a sufficiently rigid matrix (too much scaling/shearing). **kBSErrorCode_NonRigid-Matrix**
- The **coordinate-system** string does not match any coordinate system in the document. **kBSErrorCode_CoordinateSystemUnknown**

Example request:

```
{
  "packet-name": "request:create-target-at-location",

  "session-name": "Session 1",
  "name": "My new target",
  "position": [
    -0.1, -0.6, -0.8, 12.8,
    0.6, -0.7, 0.0, 54.2,
    -0.12, 0.2, 0.9, 62.9,
    0, 0, 0, 1
  ],

```

```
  "coordinate-system": "World",

  "packet-uuid": "E17E37B2-499D-4C76-AFFF-83E7F-
B6023EC"
}
Example response:
{
  "packet-name": "response:create-target-at-location",

  "response-data": {
    "name": "My new target",
    "index-path": [ 3 ],
    "position": [
      -0.1, -0.6, -0.8, 12.8,
      0.6, -0.7, 0.0, 54.2,
      -0.12, 0.2, 0.9, 62.9,
      0, 0, 0, 1
    ],
    "coordinate-system": "World",
    "uuid": "7856B7EA-36F2-4CC9-9C41-68E92F077BD6"
  },

  "error-code": 0,
  "response-to-uuid": "E17E37B2-499D-4C76-AFFF-
83E7FB6023EC",
  "packet-uuid": "7C4CF4A8-E6C0-4A1B-B540-AA-
D3A6D1DF96"
}
```

Creating a sample in the active session

This command creates a new sample in the currently active session at the crosshairs location in the Perform step. The session window must already be opened.

Request format:

- **packet-name** (required, string) : The string **request:create-sample**.
- **session-name** (optional, string) : The name of the session to create the sample in. Generally not necessary because the currently active session is presumed. Only in the case of two simultaneous sessions (for tracking two TMS coils) must the session name be provided.
- **name** (optional, string) : The name for the newly created Sample. Defaults to using Brainsight's naming convention if not provided (ex: **Sample 1**, **Sample 2**, etc.)

Response format:

- **packet-name** (required, string) : The string **response:create-sample**.
- **response-data** (required, dictionary) : Dictionary of the created sample's attributes as its keys. Note, the sample will be added to the session.
- **name** (required, string) : The name of the newly created sample. This will either be the name provided given back, or the automatically assigned name if none was given.
- **uuid** (required, string) : The uuid of the newly created sample, which uniquely identifies it amongst all

Brainsight objects.

- **position** (required, array of 16 floats) : The position and orientation of the newly created Sample expressed as a 4x4 matrix.
- **coordinate-system** (required, string) : The coordinate system of the **position** given. The coordinate system of the session's Perform step will be used. See Appendix III for details.

The action may fail if:

- No document is opened. **KBSErrorCode_NoDocuments**.
- No session with the given **session-name** is active. **KBSErrorCode_NoActiveSessionWithName**.
- No session is active. **KBSErrorCode_NoActiveSession**.
- The session window is open, but the perform step has not been activated. **KBSErrorCode_PerformStepNotLoaded**.
- The sample could not be created for the same kinds of reasons that clicking "Sample Now" in Brainsight might fail (mainly because the tracked tool is not visible). **KBSErrorCode_GeneralSampleCreationFailure**.

Example request:

```
{  
  "packet-name": "request:create-sample",  
  
  "session-name": "Session 2",
```

```
  "name": "My new sample",  
  
  "packet-uuid": "16AA49DB-13DC-4EDF-9BA2-  
47A83D845705"  
}  
Example response:  
{  
  "packet-name": "response:create-sample",  
  
  "response-data": {  
    "name": "My new sample",  
    "position": [  
      -0.7, -0.6, -0.08, 12.8,  
      0.6, -0.7, 2.9, 15.2,  
      -0.1, 0.2, 0.9, 62.7,  
      0, 0, 0, 1  
    ],  
    "coordinate-system": "World",  
    "uuid": "0056C7EA-25C2-4XY9-9C41-67E92F034BE9"  
  },  
  
  "error-code": 0,  
  "response-to-uuid": "16AA49DB-13DC-4EDF-9BA2-  
47A83D845705",  
  "packet-uuid": "C08BCCDC-626A-4F50-BB94-  
9EF4D6382271"  
}
```

Changing the target selection in the active session

This command changes the selected target to the speci-

fied one (in the active session).

Request format:

- **packet-name** (required, string) : The string **request:select-target-in-session**.
- **session-name** (optional, string) : The name of the session in which to change the selected target. Generally not necessary because the currently active session is presumed. Only in the case of two simultaneous sessions (for tracking two TMS coils) must the session name be provided.
- **index-path** (optional, 0-based array of integers) : A 0-based array of integers that represent the path to the target in the list of targets of a session. For example, the array [0, 2, 1] indicates that the target is the 2nd item [1] of the 3rd sub-folder [2] of 1st folder [0]. Note, either **index-path** or **name** must be specified, but not both. Preferred because it's unique and avoids cases where targets may have the same names.
- **name** (optional, string) : The name of a target in the list of targets in a session. One of **index-path** or **name** must be specified, but not both. If the target appears in the list multiple times, the first instance is selected.

Response format:

- **packet-name** (required, string) : The string **response:select-target-in-session**.
- **response-data** (required, dictionary) : Dictionary of

the selected target & its attributes where the attributes represent the keys to the dictionary pertaining to the session name provided and feedback if action was successful or not.

- **index-path** (required, 0-based array of integers) : The index-path of the newly selected target in the session's list of targets.
- **name** (required, string) : The name of the newly selected target.
- **uuid** (required, string) : The uuid of the newly selected target, which uniquely identifies it amongst all Brainsight objects.
- **position** (optional, array of 16 floats) : The position and orientation of the newly selected target expressed as a 4x4 matrix. Almost always present, except in the rare case of the session's target not matching the name of an actual target (i.e. the target is missing).
- **coordinate-system** (optional, string) : The coordinate system of the position given. The coordinate system of the session's Perform step will be used. See Appendix III for details.

The action may fail if:

- No document is opened. **kBSErrorCode_NoDocuments**.
- No session with the given **session-name** is active. **kBSErrorCode_NoActiveSessionWithName**.

- No session is active. **kBSErrorCode_NoActiveSession**.
- The session window is open, but the perform step has not been activated. **kBSErrorCode_PerformStepNotLoaded**.
- There's no target with the given name. **kBSErrorCode_NoTargetWithName**.
- There's no target with the given index path. **kBSErrorCode_NoTargetWithIndexPath**.

Example request:

```
{
  "packet-name": "request:select-target-in-session",

  "session-name": "Session 1",
  "index-path": [ 0, 3 ],

  "packet-uuid": "FD1249F8-C1BE-40DC-A421-61D03C403761"
}
```

Example response:

```
{
  "packet-name": "response:select-target-in-session",

  "response-data": {
    "name": "Target 2",
    "position": [
      1, 0, 0, 0,
      0, 1, 0, 0,
      0, 0, 1, 0,
```

```
      0, 0, 0, 1
    ],
    "coordinate-system": "World",
    "index-path": [ 0, 3 ],
    "uuid": "307FE810-C459-42F6-9D40-3F9DBC9E7D28"
  },

  "error-code": 0,
  "response-to-uuid": "FD1249F8-C1BE-40DC-A421-61D03C403761",
  "packet-uuid": "4C21D07F-12B8-4F88-A746-14C9D-DECA70F"
}
```

Protocol Streams

Active session crosshairs coordinate changed

This packet is streamed over to clients whenever the crosshairs changes its location (in the active Session's Perform step). Note, this takes places only during an active session.

Stream format:

- **packet-name** (required, string) : The string **stream:session-crosshairs-moved**.
- **timestamp** (required, string) : The date/time that the crosshairs moved. See Appendix II for format details.
- **crosshairs-mode** (required, string) : The mode of the crosshairs, example: **Mouse**, **Pointer**, or a name of a coil calibration. See Appendix IV for details.
- **position** (required, array of 16 floats) : The position

and orientation of the crosshairs. See Appendix III for details.

- **coordinate-system** (required, string) : the coordinate system of the **position**. The coordinate system of the session's Perform step will be used. See Appendix III for details.

Example stream:

```
{
  "packet-name": "stream:session-crosshairs-moved",
  "packet-uuid": "801CC810-FD7F-42F6-9E04-3F9D-
BBD63E69",

  "timestamp": "2024-07-26T16:32:41.348Z",
  "coordinate-system": "World",
  "crosshairs-mode": "Mouse",
  "position": [
    4, 0, 1, 0.0,
    0, 2, 0, -4.2,
    0, 0, 3, 7.5,
    0, 0, -8, 0.1
  ]
}
```

Active session selected target changed

This packet is streamed over to clients whenever the selected target in the active Session's Perform step changes.

Stream format:

- **packet-name** (required, string) : The string **stream:target-selected**.

- **timestamp** (required, string) : The date/time that the target selection changed. See Appendix II for format details.
- **name** (required, string) : If one target is now selected, the target's name. If no targets are now selected, the special string **<No Selection>**.
- **index-path** (optional, 0-based array of integers) : The index-path of the newly selected target in the session's list of targets. For the case of no selection or multiple selection, this key will not be present.
- **uuid** (optional, string) : If one target is now selected, the target's uuid. Otherwise, not present.
- **position** (optional, array of 16 floats) : If exactly one target is now selected, the target's location and orientation (as a 4x4 matrix). Usually present, but not present when: zero targets are now selected, a folder is selected, the target is missing (not matching the name of an actual target).
- **coordinate-system** (optional, string) : The coordinate system of the **position**. The coordinate system of the session's Perform step will be used. Present when **position** is. See Appendix III for details.

Example stream:

```
{
  "packet-name": "stream:target-selected",
  "packet-uuid": "A9B03439-FD7F-4FCE-9E04-8AE-
7CAD63E69",
```

```
"timestamp": "2024-07-26T15:50:59.123Z",
"name": "Marker 2",
"index-path": [ 0, 3 ],
"position": [
  0.78, 0.67, 0.09, 8.069,
  -0.55, 0.62, 0.55, 59.3,
  0.27, -0.48, 0.82, 61.88,
  0, 0, 0, 1
],
"coordinate-system": "NifTI:S:Scanner",
"uuid": "801CC810-C459-42F6-9D40-3F9DBB9E7D29"
}
```

Sample created in the active session

This packet is streamed over to clients whenever a sample is created during a session.

Stream format:

- **packet-name** (required, string) : The string **stream:sample-creation**.
- The created sample's attributes:
- **name** (required, string) : The sample's name.
- **uuid** (required, string) : The sample's uuid.
- **index** (required, integer) : The 0-based index of the newly created sample in the session's list of samples.
- **position** (required, array of 16 floats) : The sample's location and orientation (as a 4x4 matrix).
- **target-position** (optional, array of 16 floats) : The location and orientation (as a 4x4 matrix) of the target that was being targeted when the sample was

created. If no target was selected, this is not present.

- **target-name** (optional, string) : The name of the target that was being targeted when the sample was created. If no target was selected, this is not present.
- **coordinate-system** (required, string) : The coordinate system of both the **targetPosition** and the **position**. The coordinate system of the session's Perform step will be used. See Appendix III for details.
- **creation-cause** (required, integer) : An integer indicating the cause of the sample's creation. See Appendix V for details.
- **creation-date** (required, string) : The timestamp at the time of the sample's creation. See Appendix II for format details.
- **crosshairs-mode** (required, string) : The mode of the crosshairs when the sample was created, ex: **Mouse**, **Pointer**, or a coil calibration name. See Appendix IV for details.
- **crosshairs-offset** (required, float) : The offset of the crosshairs (in mm) when the sample was created.
- **crosshairs-twist** (required, float) : The crosshairs's twist (in radians) when the sample was created. (The user interface for this is only available in the Vet version of Brainsight, and is labeled "pointer twist".)

Example stream:

```
{  
  "packet-name": "stream:sample-creation",
```

```
  "packet-uuid": "D5AA04CE-861C-4463-866C-7D9EF-  
B0EB375",  
  
  "name": "Sample 1",  
  "index": 1,  
  "position": [  
    -1, 0, 0, 0,  
    0, -1, 0, 18.25,  
    0, 0, 1, 16.86,  
    0, 0, 0, 1  
  ],  
  "creation-cause": 6,  
  "creation-date": "2024-02-05T18:32:37.846Z",  
  "crosshairs-mode": "Pointer",  
  "crosshairs-offset": 0,  
  "crosshairs-twist": 0,  
  "coordinate-system": "NIFTI:S:Scanner",  
  "target-name": "Target 2",  
  "target-position": [  
    -0.69, -0.53, -0.47, 97.8,  
    0.67, -0.71, -0.18, 118.55,  
    -0.24, -0.45, 0.85, 150.84,  
    0, 0, 0, 1  
  ]  
  "uuid": "597EAD78-1E26-4EA9-949C-3708484F8427",  
}
```

EMG data received for a newly created sample

This packet is sent whenever EMG data is added to a sample, either from a Brainsight EMG Pod, or a

NeuroConn NEURO PRAX device. EMG data can arrive substantially after the creation of the sample by a TMS pulse (up to 1.2 seconds with a Brainsight EMG Pod), and so this is a separate packet from **stream:sample-creation**. In order to know about the Sample's initial creation immediately, **stream:sample-creation** is sent first and **stream:sample-emg** comes a bit later. The information in the former is repeated in the latter, so you might choose to ignore the former depending on your needs, otherwise the sample's **uuid** should be used for bookkeeping to coordinate between the two packets.

Stream format:

- **packet-name** (required, string) : The string **stream:sample-emg**.
- The sample's attributes:
 - **name** (required, string) : The sample's name.
 - **index** (required, integer) : The 0-based index of the sample in the session's list of samples.
 - **uuid** (required, string) : The sample's uuid. This matches a **uuid** from a previously received **stream:sample-creation** packet and should be used for any bookkeeping.
 - **min-emg-time-range-ms** (required, float) : The starting time, relative to the time the TMS pulse occurred, in ms, used for peak-to-peak and latency calculations.
 - **max-emg-time-range-ms** (required, float) : The ending time, relative to the time the TMS pulse

occurred, in ms, used for peak-to-peak and latency calculations.

- **waveform-info** (required, array of dictionaries) : A sorted array of dictionaries describing the EMG waveform data for each EMG channel. For the Brainsight EMG Pod, there are at most 2 channels. For the NEURO PRAX, there can be many more. The array is sorted by channel index. Each dictionary has the following keys:
 - **device-type** (required, integer) : Indicates the device that provided the EMG data: 1 for Brainsight EMG Pod, 2 for NeuroConn NEURO PRAX.
 - **channel-name** (optional, string) : Indicates the channel name, for example **EMG_16**. Will always be present for data from NEURO PRAX, and never be present for data from Brainsight EMG Pod.
 - **channel-index** (required, integer) : Indicates the zero-based channel index. For Brainsight EMG Pod, 0 for channel 1, and 1 for channel 2. For NEURO PRAX, this matches the montage order.
 - **peak-to-peak-uV** (required, float) : the EMG peak-to-peak value for the channel, in μV . The peak to peak is calculated for the time range between **min-emg-time-range-ms** and **max-emg-time-range-ms**.
 - **latency-ms** (optional, float) : the EMG latency value for the channel, in ms. The latency is calculated for the time range between **min-emg-time-range-ms** and **max-emg-time-range-ms**. This will usually be present, but it is possible for the latency algorithm

to fail, for example if the time range is very small.

- **acquisition-uV** (optional, array of floats) : The EMG waveform data for the channel. Each number represents a voltage, in μV , taken at the device's sampling frequency. For example, the Brainsight EMG Pod device samples at 3 kHz, so there will be 3000 numbers for each second of EMG data.
- **sampling-interval-ms** (required, float) : The waveform's sampling interval (reciprocal of sampling frequency). For example, the Brainsight EMG Pod device samples at 3 kHz, so this will be 0.3333333333 ms there.
- **origin-time-ms** (required, float) : The waveform's origin time, in ms. This represents the location of the first sample in the acquisition relative to where time=0 is defined. For example, a waveform created in response to a TMS stimulation records data before the stimulation. The stimulation is defined to be at time=0 and this offset tells how much data was recorded before that.
- also, to simplify bookkeeping, the following attributes from **stream:sample-creation** are repeated, see there for their meaning:
 - **creation-cause**
 - **creation-date**
 - **crosshairs-mode**
 - **crosshairs-offset**
 - **crosshairs-twist**
 - **target-name**
 - **target-position**

- **coordinate-system**
- **position**

Example stream:

```
{
  "packet-name": "stream:sample-emg",
  "packet-uuid": "03AAD82D-31C2-4806-9276-068EB88963B1",

  "name": "Sample 1",
  "index": 1,
  "position": [
    -1, 0, 0, 0,
    0, -1, 0, 18.25,
    0, 0, 1, 16.86,
    0, 0, 0, 1
  ],
  "creation-cause": 6,
  "creation-date": "2024-02-05T18:32:37.846Z",
  "crosshairs-mode": "Pointer",
  "crosshairs-offset": 0,
  "crosshairs-twist": 0,
  "coordinate-system": "NIFTI:S:Scanner",
  "target-name": "Target 2",
  "target-position": [
    -0.69, -0.53, -0.47, 97.8,
    0.67, -0.71, -0.18, 118.55,
    -0.24, -0.45, 0.85, 150.84,
    0, 0, 0, 1
  ]
}
```

```

"uuid": "597EAD78-1E26-4EA9-949C-3708484F8427",

"min-emg-time-range-ms": 10.5,
"max-emg-time-range-ms": 76.1,

"waveform-info": {
  "device-type" : 1,
  "channel-index": 0,
  "peak-to-peak-uV": 550.5,
  "latency-ms": 25.3,
  "acquisition-uV": [0.0, 0.9, 3.7, 34.5],
  "sampling-interval-ms": 0.3333333333,
  "origin-time-ms": -0.5
}
}

```

Polaris camera updated with new tool positions

This packet is sent whenever a Polaris tool location changes. One such packet is sent for every tool being tracked. The Polaris updates at 20 or 60 Hz, depending on model, so this packet is frequent.

Stream format:

- **packet-name** (required, string) : The string **stream:session-polaris-update**.
- **frame-number** (optional, integer) : A monotonically increasing integer representing the Polaris' internal clock. This is always present if the tool is visible.
- **serial-number** (required, string) : The serial number of the tool, like ST-123 or P-456. Each tool has a

unique serial number.

- **tool-in-sensor** (optional, array of 16 floats) : The location and orientation (as a 4x4 matrix) of the tool in the Polaris' coordinate system. This is provided when the tool is visible to the camera, and absent when the tool is not visible. See Polaris documentation for details of this coordinate system. In brief, the origin is at the midpoint between the two camera lenses.
- **tool-in-desired** (optional, array of 16 floats) : The location and orientation (as a 4x4 matrix) of the tool in the **coordinate-system** coordinate system. The coordinate system of the session's Perform step will be used. This is provided only when subject registration has been performed and when the tools are visible to the camera; it is absent otherwise.
- **coordinate-system** (required, string) : The coordinate system of **tool-in-desired**. See Appendix III for details.
- **timestamp** (required, string) : The date/time that the data was received from the Polaris. See Appendix II for format details. For more exact time keeping, use the **frame-number**.

Example stream:

```

{
  "packet-name": "stream:session-polaris-update",
  "packet-uuid": "47A2E0F8-3F98-447F-A282-ACC8C1A002F0",

```

```

"frame-number": 34255,
"serial-number": "ST-123",
"tool-in-sensor": [
  0.7065256352896276, 0.7076874498523965, 0, -100,
  -0.7076874498523965, 0.7065256352896276, 0, 0,
  0, 0, 1, -1750,
  0, 0, 0, 1
]
"tool-in-desired": [
  -0.69, -0.53, -0.47, 97.8,
  0.67, -0.71, -0.18, 118.55,
  -0.24, -0.45, 0.85, 150.84,
  0, 0, 0, 1
]
"coordinate-system": "World",
"timestamp": "2024-07-26T15:50:59.123Z"
}

```

IOBox TTL trigger occurred

This packet is sent whenever one of the TTL triggers on the IOBox is triggered.

Stream format:

- **packet-name** (required, string) : The string **stream:session-ttl-triggers**.
- **timestamp** (required, string): The date and timestamp of when the trigger occurred. See Appendix II for format details.
- **t1** (required, boolean) : True if TTL1 was triggered, false if it not.

- **ttl2** (required, boolean) : True if TTL2 was triggered, false if it not.
- **ttl-switch** (required, boolean) : True if TTLSwitch was triggered, false if it not.

Example stream:

```
{
  "packet-name": "stream:session-ttl-triggers",
  "packet-uuid": "FC77310D-DD10-4C01-92D6-
BBF848BFFBE0",

  "timestamp": "2024-06-19T16:57:29.834Z",
  "ttl1": true,
  "ttl2": false,
  "ttl-switch": false
}
```

Appendix I: Error Codes

The following numerical values may be returned as the **error-code** is a response packet. Their name should give an idea

- kBSErrorCode_NoError = 0,
- kBSErrorCode_PacketInvalidJSON = 100,
- kBSErrorCode_PacketNameInvalid = 101,
- kBSErrorCode_PacketUUIDInvalid = 102,
- kBSErrorCode_RequiredFieldMissing = 103,
- kBSErrorCode_WrongType = 104,
- kBSErrorCode_TooLong = 105,
- kBSErrorCode_TooShort = 106,

- kBSErrorCode_InvalidCombination = 107,
- kBSErrorCode_NoDocuments = 201,
- kBSErrorCode_MoreThanOneDocument = 202,
- kBSErrorCode_NoActiveSession = 301,
- kBSErrorCode_NoActiveSessionWithName = 302,
- kBSErrorCode_PerformStepNotLoaded = 303,
- kBSErrorCode_MatrixSizeNot4x4 = 401,
- kBSErrorCode_CrazyFloatingPoint = 402,
- kBSErrorCode_NonInvertibleMatrix = 403,
- kBSErrorCode_NonRigidMatrix = 404,
- kBSErrorCode_CoordinateSystemUnknown = 501,
- kBSErrorCode_GeneralSampleCreationFailure = 601,
- kBSErrorCode_InvalidStreamName = 801,
- kBSErrorCode_NoTargetWithName = 901,
- kBSErrorCode_NoTargetWithIndexPath = 902,

Appendix II: Date and time format

All timestamps used in this protocol are strings in ISO 8601 format. They are always in the UTC time zone. They include 3 digits of milliseconds. The exact Unicode date format pattern used is **yyyy-MM-dd'T'HH:mm:ss.SSS'Z'**.

Appendix III: Positions, orientations, coordinate systems

- Positions/orientations are represented as 4x4 matrices, as an array of 16 floating point numbers. They are in row-major order. The matrix must be invertible. The position components are in mm.

- Coordinate systems are identified by one of the following strings:

- Brainsight
- World
- NIFTI:S:Scanner
- NIFTI:Q:Scanner
- NIFTI:S:Aligned
- NIFTI:Q:Aligned
- NIFTI:S:MNI-152
- NIFTI:Q:MNI-152
- NIFTI:S:Talairach
- NIFTI:Q:Talairach
- NIFTI:S:Other-Template
- NIFTI:Q:Other-Template
- MNI
- MNI Rhesus
- MNI Cynomolgus
- MNI Macaque
- Talairach
- Paxinos
- Fraunhofer Sheep
- Saleem D99
- Marmoset
- Pig

- Cornell Canine

These correspond to same names used in the Brainsight user interface.

Appendix IV: Crosshairs Modes

The 'crosshairs mode' corresponds to the selection in the "Driver" popup menu in the Brainsight session window.

- **None** - corresponds to "None" in the "Driver" popup menu.
- **Mouse** - corresponds to "Mouse" in the "Driver" popup menu.
- **Pointer** - corresponds to "Pointer" in the "Driver" popup menu.
- **Placed Chamber** - corresponds to selecting a placed chamber in the the "Driver" popup menu.
- **Axilum Arm** - corresponds to "Axilum Arm" in the "Driver" popup menu.
- **Vet Robot** - corresponds to "Vet Robot" in the "Driver" popup menu.
- or the name of a Tool Calibration
- **Unknown** - a fallback in the unlikely case that none of the above apply.

Appendix V: Sample Creation Causes

The following are possible integer values for a sample's 'creation cause', they indicate what mechanism was used to create the sample.

- 0: created by pressing the "Sample Now" button in

Brainsight's Perform window.

- 1: created by speech recognition, for example, speaking the phrase "Sample".
- 2: created by a press of an Apple Remote play button .
- 6: created by the TTL1 trigger on the IOBox.
- 7: created by the TTL2 trigger on the IOBox.
- 8: created by the Switch trigger on the IOBox.
- 9: created by a Neuro PRAX device communicating to Brainsight.
- 10: created by a client using the network protocol described in this document.
- 5: a fallback in the unlikely case that none of the above apply.

Chapter 18: Special Application–Axilum Robot

One exciting new development in the field of TMS is the applications of modern robotics. Robotics can assist in the placement of the coil in many ways, including:

- Consistent, accurate coil placement
- Automatic compensation for head movement
- Easy application of multiple targets (e.g. grid)

This chapter will cover the details of the Brainsight support for the Axilum robot. You are expected to be proficient with the other features of Brainsight and this chapter can be seen as an addition to the Perform Session chapter.

Additionally, review the “TMS–Robot User Guide” documentation provided by Axilum, and especially “Section 3 – General Safety Warnings and Precautions of Use” for important safety information.

INTRODUCTION

Neuronavigation applied to TMS has revolutionized the field of TMS by allowing more sophisticated definitions of the TMS target (e.g. based on anatomy or functional data), improving placement accuracy and recording of the coil position and orientation during the entire TMS session to ensure consistent placement.

Just like using a GPS, while the information may be useful, it is still only as good as the driver. Using a robot to hold and place the coil offers several additional advantages over navigation alone.

- Ensures correct application of the coil based on the navigator.
- Easier for the operator.
- Allows for compensation of head movement .
- Allows for the automation of common tasks.

Prerequisites

When performing a study using the Axilum TMS-Robot or Cobot there are several additional prerequisites:

- Make sure that you have a Polaris camera with extended measurement volume and wide angle of view (e.g. Polaris Spectra or Vega), which are needed in this case to simultaneously track the robot tracker, subject tracker, and the custom coil tracker.
- Make sure that you have a coil that is supported by your version of the Axilum robot. To check which coils are supported refer to section 1.1 of the

"TMS-Robot User Guide".

SETTING UP BEFORE A STUDY

Many of the steps involved in using the robot are the same as for conventional TMS use. Refer to the relevant parts of this user manual to understand these tasks.

Special notes in preparing a Brainsight project

When preparing a Brainsight project file, follow the steps in loading images, creating 3D surfaces and selecting registration landmarks as you normally would.

There are some considerations when selecting targets:

- All targets must be trajectories. The Axilum robot needs explicit instructions as to the desired position AND orientation of the coil.
- While the target can be set in the cortex as we would for manual TMS, the robot requires that Brainsight provide a scalp based target and orientation. At the time of the TMS session, there is a function in Brainsight to convert the cortical-based target (which is more intuitive and relevant for humans to define and understand) to the scalp based target more appropriate for the robot to accomplish. The scalp-based target will simply be the location on the scalp that lies along the vector (see Fig. 18-1).

Creating a grid of targets

Brainsight supports the creation of grids of various shapes and sizes and can be defined as markers (locations without tool orientation information) or trajec-

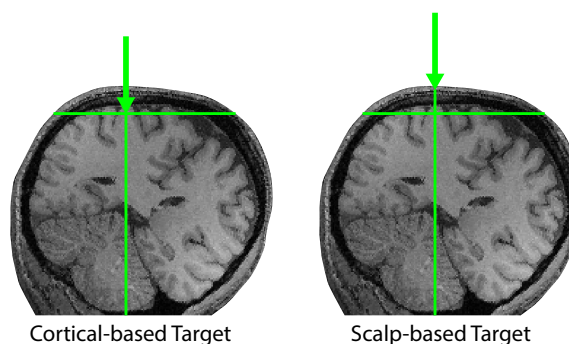

Fig. 18-1

Illustration of a cortical-based target and the equivalent scalp-based target.

tories. While a human holding the coil might be able to deduce the orientation and scalp location of the coil implicitly, robot requires an explicit target and trajectory. When creating a grid (see "Creating a grid of targets" on page 100), ensure that the trajectory of each node is appropriate using the optimizer tool and/or manually setting the orientation using the sliders.

Typical Additional Initial Steps for a Robot-based TMS Session

- Have the subject sit in the Robot chair
- Verify and if needed, adjust the location of the subject tracker to ensure it will be visible by the position sensor and not be near the intended location of the coil.

- In addition to the usual TMS hardware preparation steps described in Chapter 16, when using the Axilum TMS-Robot, one has to attach the coil cable to the cable holder as described in Section 9 of the "TMS-Robot User Guide".

Begin the the Session

- Launch Brainsight and open a new online session or resume a previously created online session as described in Chapter 16.
- If Brainsight has been correctly installed and the correct serial number introduced, the session window should feature an Axilum tab (Fig. 18-2). Selecting that tab will display the Axilum control window (Fig. 18-3).

Verify Polaris Camera Position

When positioning the Polaris camera for a robot-assisted session we must make sure to satisfy the following conditions:

- the camera field of view spans high enough to detect the Axilum Tracker which is located on the upper front side of the robot
- the camera field of view spans low enough to include the general area where the subject tracker will be positioned. Note that the robot seat can be moved up and down to accommodate the subject's height. An example of a good camera positioning is given in Fig. 18-3.

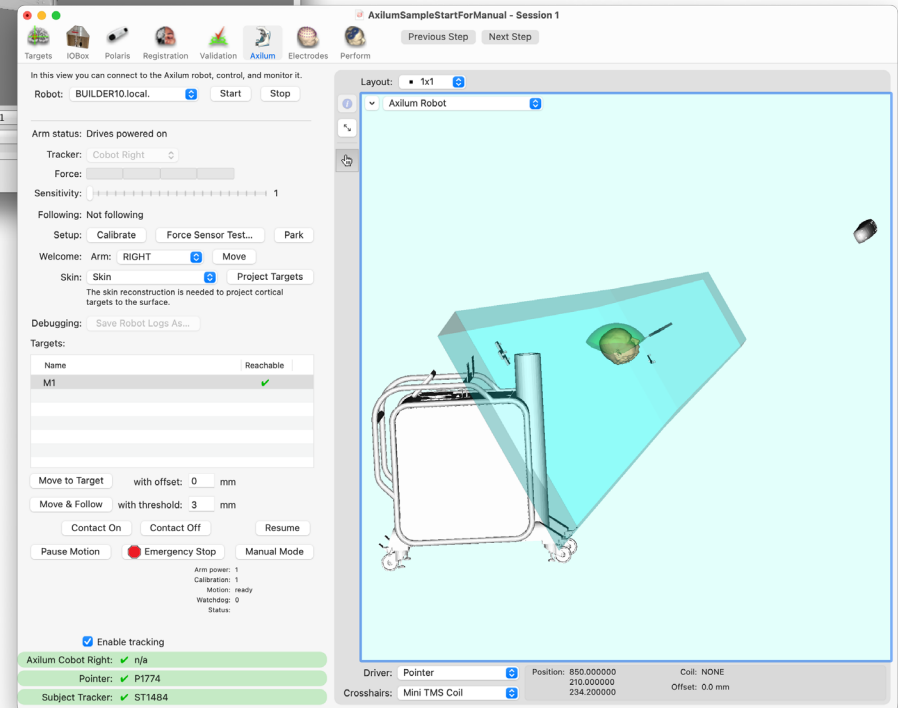
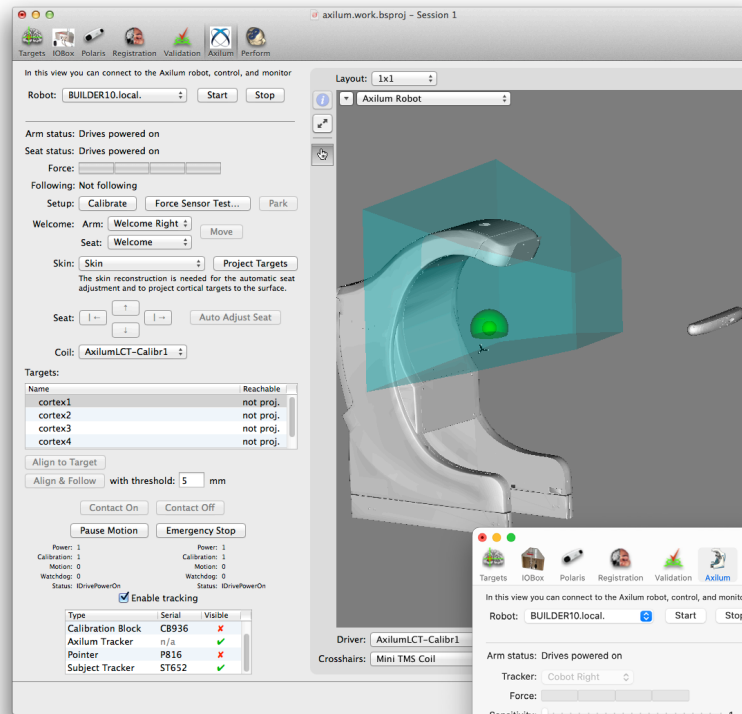
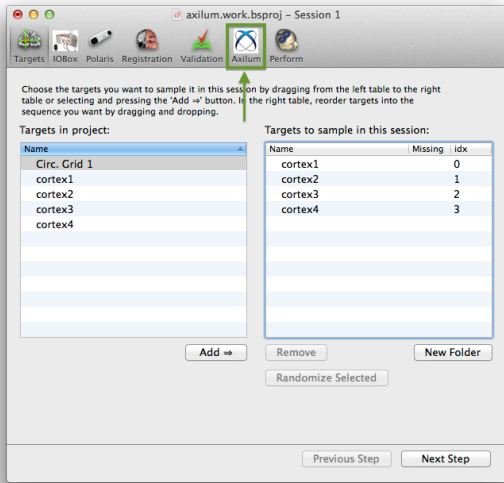

Fig. 18-2
Session Perform Screen with Axilum Step

Fig. 18-3
Axilum Robot Controls (Axilum Step)

SEQUENCE OF STEPS FOR THE COBOT

When using the Cobot, certain steps need to be done in a specific order to ensure that all the hardware is communicating as needed. In general, when performing a Cobot session, these steps need to be done in order:

- Make sure the Ethernet router that connects the Polaris camera, Brainsight computer and Cobot is turned on. Give it at least 2 minutes to start up completely (so it can give IP addresses to all the components)
- Turn on the Polaris (it is likely already on as may receive power from the Ethernet cable).
- Turn on the Brainsight computer, launch Brainsight and open the Polaris configuration window (Windows->Polaris Configuration) and make sure Brainsight has connected to the Polaris and is tracking. This step is important to prevent the Cobot from locking the Polaris camera as it boots.
- Turn on the Cobot. Note that as it boots, it will report that the Polaris camera cannot be found. This is expected (and desired as Brainsight needs the camera, not the Cobot).
- Once the Cobot has reached its main screen, tap the MCP (manual control panel) to put the Cobot into a mode that allows it to receive commands from Brainsight. Note that the Cobot will remain in this mode, even after shutting down and restarting until you return the robot to the maintenance mode.

When the Cobot starts in MCP mode, you do not need to perform the previous steps as it will not attempt to lock the Polaris camera.

Prepare the robot (part I – before registration)

Prior to performing the subject registration/verification, certain robot-specific tasks should be performed to ensure that Brainsight is connected to, and controlling the robot (see previous section for the correct procedure to power up all the hardware for the Cobot).

- If the robot is not already powered on, follow the instructions in Section 10.4 of the “TMS-Robot User Guide” to boot the robot. Once the robot is on, Brainsight will detect it and its name will appear at the top of the Axilum screen, next to the Start and Stop buttons. If the robot is on but Brainsight fails to detect the robot, check that the robot is connected to the Brainsight system, or re-launch Brainsight.
- Once Brainsight has detected the robot, press **Start** to connect to the robot.
- For the Gen 1 robot: If the **Arm status** and **Seat status** on the Axilum screen are “Not calibrated”, it means

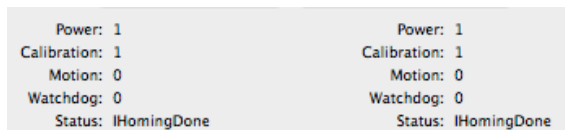

Fig. 18-4

Robot status flags after calibration (initialization)

that the robot needs to be calibrated, i.e. initialized. There are two alternative ways to initialize the robot:

IMPORTANT: For either of the following methods, you might need to remove the back seat (not applicable for the cobot) before starting the initialization process. Refer to the “TMS-Robot User Guide” for details.

- Initialize the robot by using its physical control panel, as described in Section 10.5 of the “TMS-Robot User Guide”.
- or
- Initialize the robot from Brainsight, by pressing the Calibrate button, and waiting for the robot arm and robot seat movements to complete. For the Cobot, this is the only method of calibrating the robot, so click **Calibrate** after Brainsight connects to the Cobot.

Once initialized, the robot status flags displayed in the lower part of the Axilum screen should indicate that both the arm and the seat are powered and calibrated.

The force sensor on the robot arm is needed for the robot to place the coil on the scalp with the desired pressure as well as a safety measure to protect the subject. It allows the robot arm to detect when it applies excessive pressure and to halt the movement.

- Perform the force sensor check by clicking **Force Sensor Test** in the Axilum view. This will bring up a window that will guide you through the check procedure. In order to pass the check, you must successively press with your finger on the focal

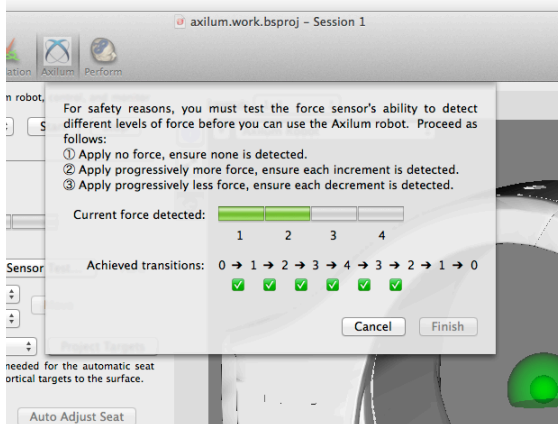

Fig. 18-5

Force sensor check procedure screen

point of the mounted coil, until you achieve all the required force levels in the described order (see Fig. 14-6). Once all the force levels are tested, the Finish button will activate, which indicates that the procedure has been successfully passed.



IMPORTANT NOTE: Check the force sensor every time you replace or unmount the coil.

- In order to make it easy for a subject to sit in the robot seat, the robot arm and seat are moved to one of the “welcome positions”. To do so, select a welcome position for the arm (either left or right) and for the seat using the appropriate popup buttons in the Axilum control window (recall Fig. 18-3), and

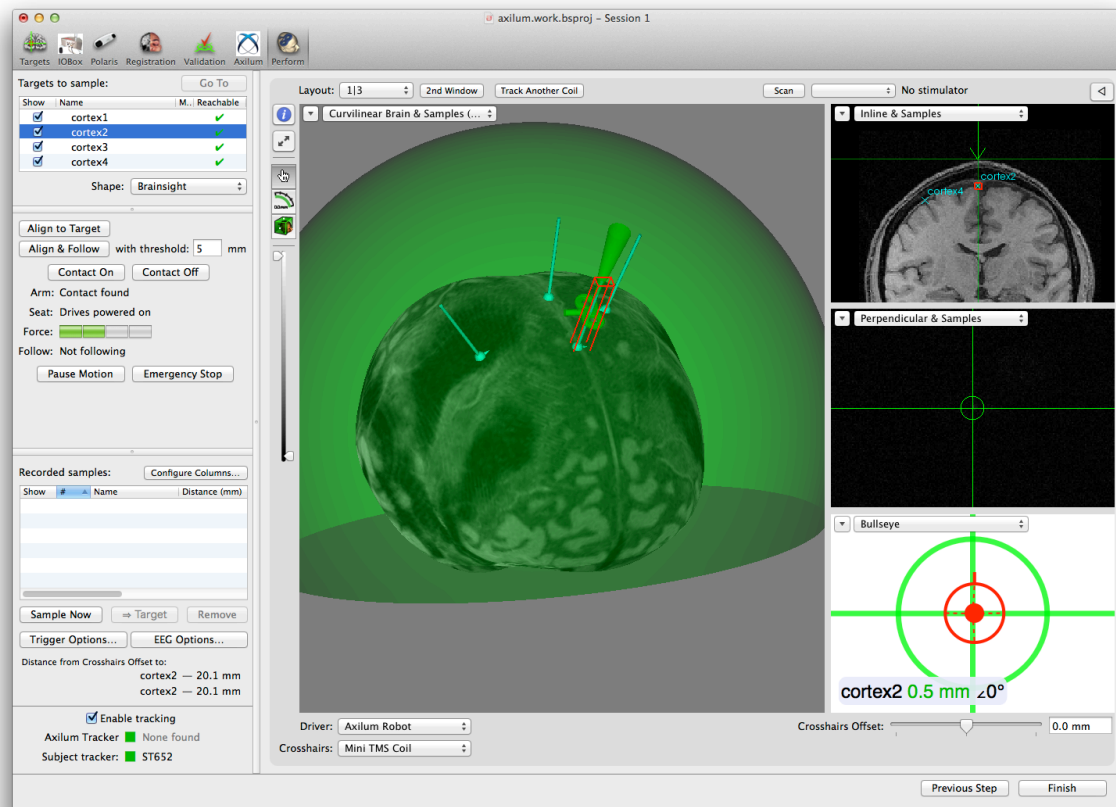

Fig. 18-6

Typical Perform screen for a robot-assisted TMS session.

press **Move**. You should observe the arm and chair move to the welcome position. Depending on which welcome position has been selected (left or right), the subject will be able to access the seat from the respective side of the robot.

- Have the subject sit on the seat and adjust the headrest as directed in the Axilum documentation taking care not to place the headrest where it may interfere with the robot’s motion (e.g. obscuring a TMS target).
- Make sure subject tracker is visible to the camera by observing in the 3D view on the Axilum screen where the Polaris field of view is displayed along with the visible trackers and a representation of the robots range of motion (the green half-sphere). You can adjust the seat height to aid in ensuring that the trackers are visible by clicking on the appropriate seat movement buttons in the Axilum screen.
- Perform subject registration as done for a manual TMS session (see “Perform the Subject-Image Registration (Subject-Specific Images)” on page 118).

Steps After Subject Registration

Before proceeding, confirm sure that:

- The force sensor check has been performed.
- The robot is in one of the welcome positions.
- The subject is in the seat.

- The subject registration has been done.
- At least one target has been added to this session.
- At least one skin reconstruction has been created from the anatomical data (refer to Chapter 13).

Referring back to the Axilum control screen:

- If you created more than one skin reconstruction, select the one you wish to use for the robot-assisted TMS session. The skin reconstruction is needed for: (1) the seat auto adjustment functionality, and (2) the projection of the cortex targets to the scalp

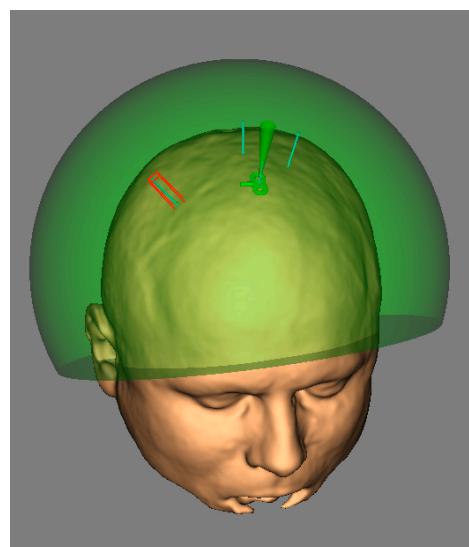

Fig. 18-7

Example of a head position that is well inside the robot's working space.

surface (see following steps for details).

- Click **Auto Adjust Seat (not applicable for the Cobot)**, which will automatically adjust the vertical position of the seat so that the subject head is falls in the robot working area, which is represented by the green hemisphere (Fig. 18-7)
- As discussed earlier in this chapter, any target needs to be projected onto the scalp to define the location for the robot to place the coil on the scalp. Instruct Brainsight to do this now by clicking **Project Targets**. Once this has been performed, examine the targets listed in the targets list to ensure that the robot can reach each one. This is indicated by a green check-box in the **Reachable** column in the target list (Fig. 18-8). For more details about the factors that make a target reachable or not, see section “Robot workspace and target reachability” later in this chapter. Note that the offset assumes the robot has

Targets:	
Name	Reachable
cortex1	✓
cortex2	✓
cortex3	✗
cortex4	✓

Fig. 18-8

Example of a list of targets. Notice the cortex3 target is not reachable.

direct access to the scalp of the subject.

- Select the coil installed on the robot in the **Coil** popup button in the Axilum control screen. As in the case of a manual TMS session, selecting the wrong coil calibration can result in incorrect targeting.
- For visualization purposes, select the same coil from the **Driver** popup button.

Perform the stimulation

Before proceeding with this section, make sure that:

- The targets you are interested in are reachable by the robot, if not, review section “Robot workspace and target reachability” before continuing.
- You successfully performed the force sensor check.
- The subject registration did not change (e.g. did not move head strap or tracker glasses).
- The subject is seated comfortably and ready.
- Select the Perform step by clicking **Next Step** or by clicking the **Perform** icon at the top of the window.
- The perform step uses a default layout that we expect to be useful for the manual perform task. If desired, optimize the screen layout for a robot-assisted TMS session by:
 - Set layout to 1|3
 - Set the large image view to **Curvilinear Brain and Samples** (create curvilinear reconstruction if not created yet)

- Set the smaller views to: Inline & Samples (or Inline-90 and Samples), Perpendicular & Samples, and Bullseye.
- Customize the Curvilinear Brain and Samples view by clicking the list again and selecting **Customise...** at the bottom of the list. The customize view selector window will appear (Fig. 14-9).

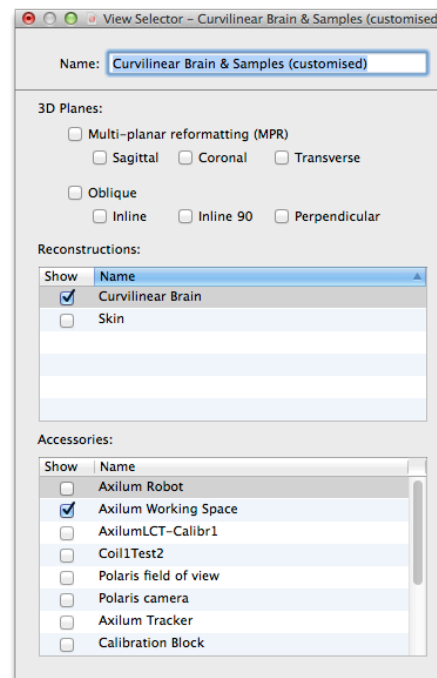

Fig. 18-9
Customize View Selector Screen.

- Select “Curvilinear Brain” from the reconstructions list and optionally the Skin (best if the Skin’s opacity was set to something around 50% to see the Curvilinear Brain inside) then select “Axilum Working Space” from the Accessories list.
- Close the window (click on the red button)
- Select a reachable target in the “Targets to sample” list by clicking on it.
- Click **Move To Target**, which will perform the first stage of the robot movement, i.e. will align the robot arm with the target’s orientation and hover the coil roughly over the target, then it will descend to the target.

Note: The move to target assumes that the coil will be able to come into direct contact with the scalp. If the subject is wearing an EEG cap (or has thick hair), you may need to add an offset to compensate for this thickness in the with offset field.
- You can verify the targeting error in the Bullseye view.
- If the subject moves their head after the robot motion completes, you can click **Move and Follow** (while keeping the same target selected) for the robot to re-align the arm to the target and continuously track the head and make real-time adjustments. Set the desired threshold to initiate movement compensation in the **Threshold** field.
- If alignment is good, you can apply TMS stimulation

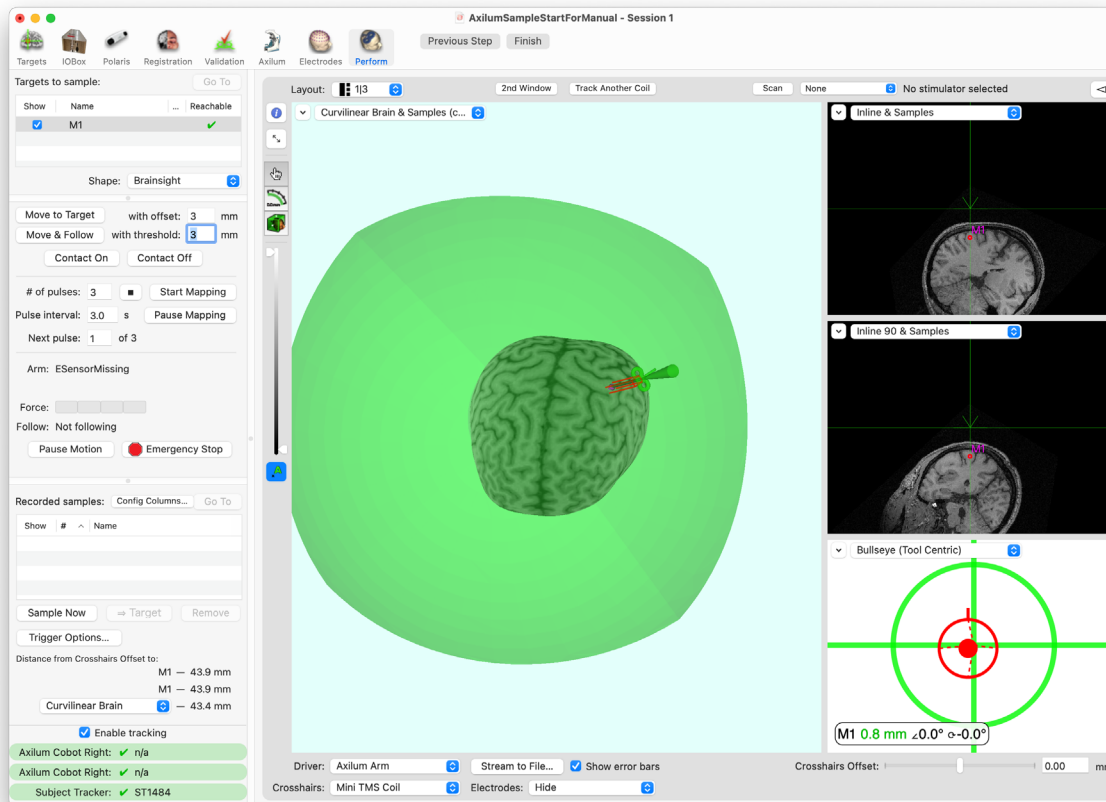

Fig. 18-10

Perform window with robot and mapping controls

as planned.

- If alignment error is unsatisfactory, check coil calibration, check that nothing obstructs the movement of the coil, and check the target position and orientation.
- Once TMS stimulation has been applied, the next target can be selected (if more than one target exists). There are two methods:
 - If the next target is close to the current target, i.e. within approximately 30mm, you can select the next target and click **Move to Target**. The robot arm will slide the coil along the head of the subject from the current target to the next one.
 - If the next target is not close to the current target, the robot will pull back to a safe distance from the head, move to hover over the target and then lower to the head until contact is made.

If you wish to move the coil off the head, click **Contact Off** and the coil will move back to its "orbiting" position. Click **Contact On** to put coil in contact with head.

SIMPLE MAPPING

If you have created a grid of points and wish to move the coil systematically to each target, then you can use the mapping feature. Essentially you need to set up a list of targets in the target list (it can, and often is a grid), select the first one and initiate the mapping. Can set the number of pulses per target (we don't fire the coil directly,

but will display a visual queue on the screen when to fire the coil yourself) and the pause time between pulses.

- Ensure that all nodes of your grid (or list of targets) is reachable.
- Set the number of pulses per site by entering the number in the **# pulses** field. You can make the visible cue appear in a floating window by clicking the **black square** button next to the # pulses field.
- Set the time interval between pulses (e.g. 1 or more seconds) by entering the value in the **Pulse interval** field.
- Select the first target in the list and click **Start Mapping**. The robot will move the coil to the first target and then begin pulsing by toggling the cue black to white. Note the count will increment in the **Next Pulse** field. You can override that number by entering it yourself (e.g. to restart counting).
- Stop the mapping by clicking **Pause mapping**.

WORKSPACE AND TARGET REACHABILITY

The robot working space is the part of the 3D space that is reachable by the robot. We define a target to be reachable by the robot, and is displayed as such in Brainsight, when it falls within the working space. Targets that fall outside the space are not reachable.

In addition to the position, some targets can be unreachable due to their orientation being unreproducible (e.g. a target where the coil would need to be oriented upside-

down, or would need to go into the head).

In Brainsight 3D views, the workspace is represented as a green hollow semi-sphere. Depending on how the subject moves, the head might fall inside the working space, partially inside, or completely outside. In order to make as many targets reachable at any given time, it is recommended to position the head of the subject relative to the working space as shown in Fig. 18-7.



Chapter 19: Special Application–Motor Mapping

One common application of TMS is studying motor evoked potentials (MEPs). These are the signals sent to a muscle or muscle group from the brain resulting from a TMS pulse. One method of studying MEPs is to use EMG (Electromyography) to record the MEP generated at the muscle while firing the coil over multiple regions of the brain. The resulting MEPs can be mapped back to the original stimulation locations on the cortex to generate a cartographic map on the brain.

This chapter describes how to use Brainsight to generate such a map. It would be a good idea to read this chapter prior to performing the TMS session to ensure that your protocol will provide the right data needed to generate the MEP maps.

INTRODUCTION

Brainsight allows you to generate two types of visual representation of MEP responses on the cortex. The first is a new method of color-coding the traditional 3D markers that are generated when the coil location is recorded, and the second is a method to generate an overlay that can be visualized on the brain much like a functional overlay.

The MEP data required to generate these maps can be provided in real-time using the built-in EMG acquisition pod now available from us (and comes standard with new Brainsight systems that include the computer/trolley) or by entering the MEP peak-to-peak response manually derived from another EMG device.

There are many protocols to perform this procedure that are independent of the equipment used. For this reason, we only **suggest** a typical method in this chapter. It is important for you to understand what you are measuring and how you want to measure it. As consensus builds on how these become more standardized, we will continue to evolve this tool to simplify the process for standardized methods. In that spirit, we welcome your input in this area as we move forward.

TARGET CONSIDERATIONS

If you plan on performing a motor mapping exercise, consider using a grid over your target area (see Fig. 19-1 for an example). This will ensure that you will acquire enough data without gaps that may affect the shape of

the map. It is also important to ensure that the map be bounded by values low enough to be below the threshold of significance. This will ensure that the intensities of the map will decay at the edges, increasing the confidence that the location of maximum value occurs within the map.

Fig. 19-1

Typical mapping setup with a grid surrounding the area to be mapped.

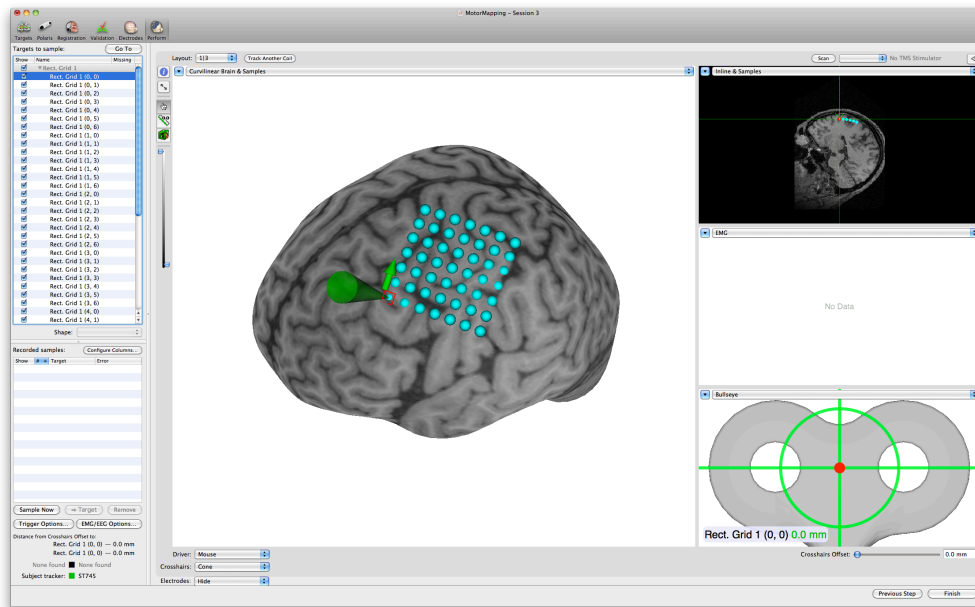

INPUT EMG DATA

The peak-to-peak responses are used as the input to the mapping process. The peak-to-peak can be derived automatically from the EMG waveform acquired by the EMG pod, or entered manually. Manual entries are used when the EMG data is acquired by an external device OR to override a value derived from the EMG sample (you might do this for example, to set an obviously noisy sample to 0) .

Built-in EMG Pod

If you are using the built-in EMG pod, set it up as described in "EMG Pod" on page 29. You can view the EMG data in the waveform window (Fig. 19-2). After acquiring a few visible MEPs, set the MEP window (by moving the vertical green bars) to crop the waveform. The important point is to ensure that only the "real" EMG response is used to calculate the peak-to-peak response, not the artifact from the TMS pulse or other noise.

Fig. 19-2

MEP screen

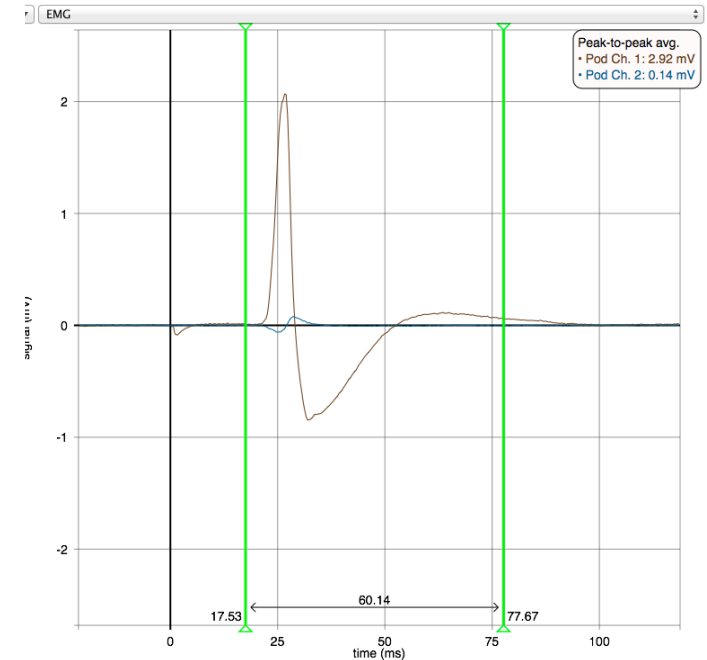

Ensure that you are using a TMS output setting high enough to generate supra-threshold responses (so you see the waveform) but not so high that you saturate the amplifiers (about 5 mV peak-to-peak), or you may use a percentage of the motor threshold. This may take some experimenting.

Once set up, the peak-to-peak values will be used automatically for the mapping. Note that any time you change the MEP window settings, all the peak-to-peak values will be re-calculated.

Entering the values manually

- Make sure that the coil location is being acquired automatically when the coil is fired (or make sure you record the location manually).
- In the sample entries box (either in the perform window or the review window), click Configure Columns..., and enable Peak-to-Peak.
- After each sample is acquired (or at any time during the study), enter the peak-to-peak value derived from the external source into the field within the samples list box.

VISUALIZING MAP DATA

You can visualize the MEP map in two ways. First, the MEP values can be used to colourize the 3D representations of the samples according to the MEP value associated with that sample. Second, the samples can be projected into a 3D overlay data set and displayed

on the curvilinear brain. The marker colourizing has the advantage of being real-time in that the colours are set as soon as the MEP value is entered (either automatically by the EMG pod or manually by typing the values in). The overlay map has the advantage of being easier to interpret. Both methods can be used at any time or together,

so one does not have to be chosen over the other.

Marker coloring

- In the Perform (or review) window, click the inspector button (the blue circle with the "i"). Click on **Motor Maps**.

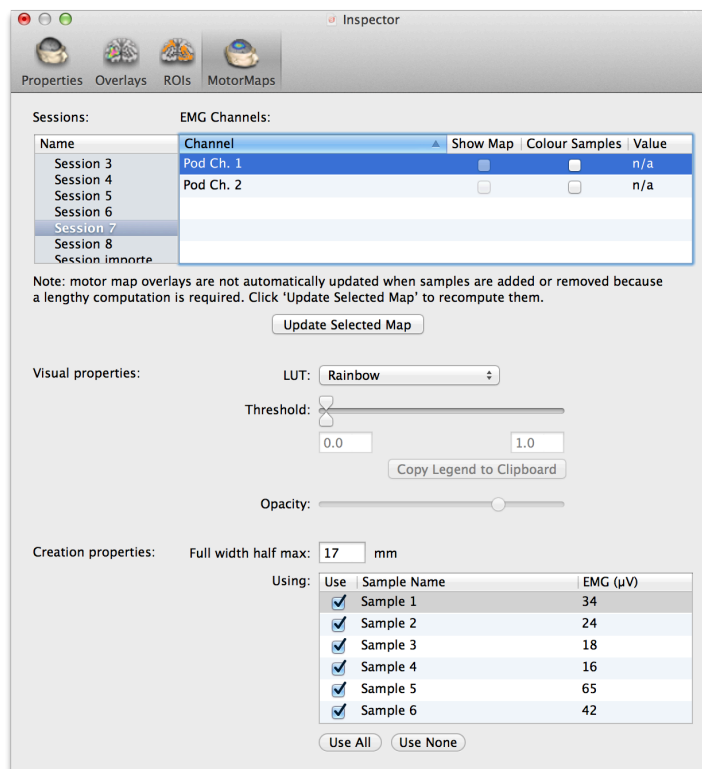

Fig. 19-3

MEP mapping configuration screen

- Select the session that contains the data to map by clicking on it in the sessions list on the left.
- Select the EMG Channel you wish to colourize.
- Enable the **Colour Samples** associated with that EMG channel.
- Select the desired lookup table, and set the upper and lower thresholds to obtain a map that displays the desired data. Typically, the lower threshold is set to a voltage that is below what you consider to be significant (e.g. 50 μ V).

Creating the map as an overlay

The overlay map is designed to try to generate a smooth cartographic map that can be easier to interpret than the colored markers (see Fig. 19-4 for an example). Having a good understanding of the method we have implemented is important in interpreting the display effectively. Refer to the next section for details on the algorithm.

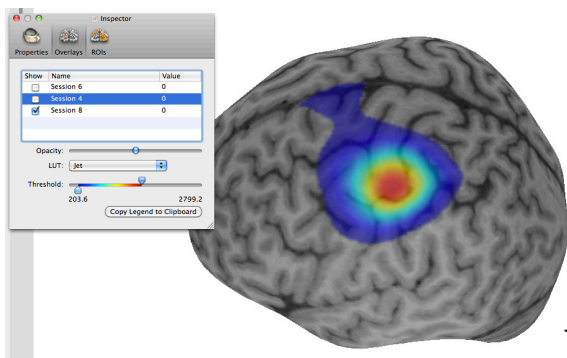

Fig. 19-4

Typical motor mapping result displayed on the curvilinear

Generating an MEP map overlay:

- Once you have collected your data, click on the inspector button, and select **motor map**.
- Disable any samples you want to exclude from the calculation by de-selecting the Use checkbox,
- Set the FWHM value (see “Caveats in using the MEP display” for recommended values of this parameter).
- Click **Update Maps**. After a moment, the map will be calculated.
- Enable the **Show Maps** check box to display the map.
- Select the desired lookup table, and set the upper and lower thresholds to obtain a map that has a smooth edge. Typically, the lower threshold is set to a voltage that is below what you consider to be significant.
- If you change the FWHM (full width half max) value, remember to click **Update Maps** to update the map. Changing the LUT selection or the upper and lower

thresholds do not require the map to be recalculated and the changes are updated in real time.

Detailed Description of the Mapping Algorithm

When each MEP value is acquired, it is associated with the position and orientation of the coil recorded in the sample. If you think of each sample as being a cylinder that runs along that trajectory, you can project that MEP value into the volume defined by the anatomical images. Any voxel that lies inside the cylinder is assigned the MEP value and a weighting factor. The weighting is 1.0 along the trajectory, and drops off the further away from the centreline using a Gaussian function. You can set the width of that cylinder by changing the full width at half maximum (FWHM) of the Gaussian. Fig. 19-5 illustrates the method.

Since many voxels will have multiple samples that intersect it, the MEP values at each voxel can be calculated by taking the weighted sum of all the samples that intersect the voxel. This method ensures that any voxel that is surrounded by MEP measurements will be assigned a weighed average of the neighboring MEP samples. Any voxel that lies along the periphery of the region of samples (since it is impractical and unnecessary to sample the entire head) will be assigned the value of the only sample that intersects it. This means that the MEP region will not smoothly drop to 0 as we exit the sampled region. It is important to ensure that the region sampled be larger than the region of interest so that the sampled values along the periphery of the region are below the

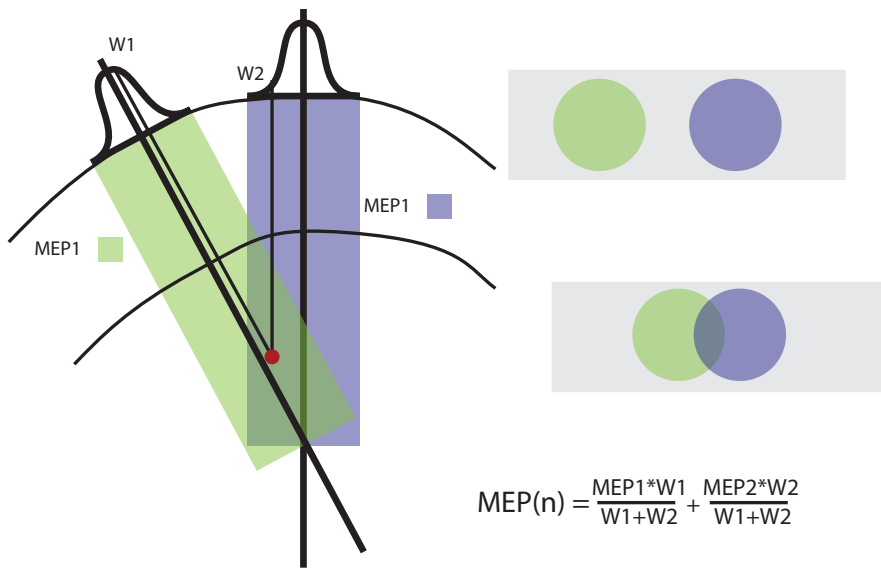

Fig. 19-5

Illustration of the algorithm used to interpolate the MEP values to generate a smooth map.

lower threshold.

Caveats in using the MEP display

The motor map display can be very a very useful tool in visualizing the MEP distribution, however there are several things to consider when using it.

Depth: The data display can be thought of as a 2D cartographic representation of the MEP data, and projected onto the curvilinear surfaces. The data is inherently NOT 3D data in that there is no real depth information, and the projection we perform is strictly a trick to paint the curvilinear surfaces.

FWHM: The width of the cylindrical projections into the volume will have an effect on the appearance of the map display. If the FWHM is set too small when compared to the spacing between your samples, then the cylinders may not intersect each other, leaving gaps in the interpolation (Fig. 15-5, top image). As you increase the FWHM, the spread of each sample will widen and eventually overlap. This ensures that the interpolation will be continuous. This also has the effect of blurring the data as well. If you set the FWHM too high, you may blur out the peak. A good rule of thumb is to use a FWHM that is at or above the spacing between your samples. For example, if you created a sampling grid with 10mm spacing, then set the FWHM to at least 20mm.

Threshold: The threshold is used to mask out values that are below the threshold of significance. Typically this is a value that is above the observed noise value

of the acquired data, or a task specific threshold. For example, many motor threshold exercises consider $50\mu\text{V}$ the threshold for resting motor threshold. Reducing the upper threshold often makes it easier to see where a peak may have occurred.

Curvilinear peel depth: The curvilinear peel depth is usually selected to allow you to see the gyral anatomy you are interested in. Note that since the trajectories of the coil placement are generally not parallel, the interpolated map will change slightly as you peel deeper. If you are comparing motor maps for the same subject across different mapping sessions, it is advisable to compare them using a constant depth.

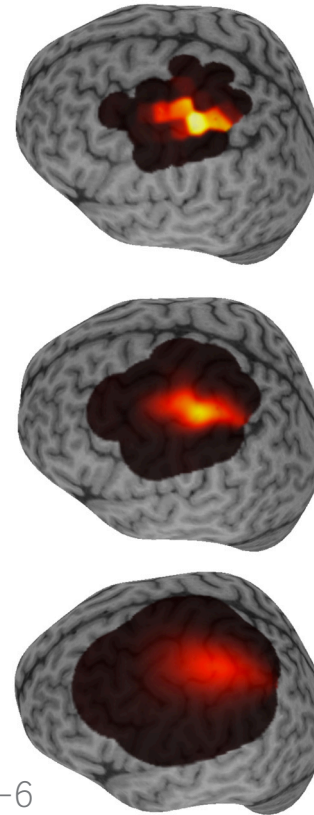

Fig. 19-6

Examples of different FWHM on the same motor map. The upper one used a 5mm FWHM resulting in gaps and a poor interpolation. Middle: 10mm FWHM, with improved appearance but still with a step interpolation. Bottom: FWHM of 20mm showing a better appearance. Note the higher FWHM has the side effect of lowering the peak value because it was blurred by the surrounding lower values.

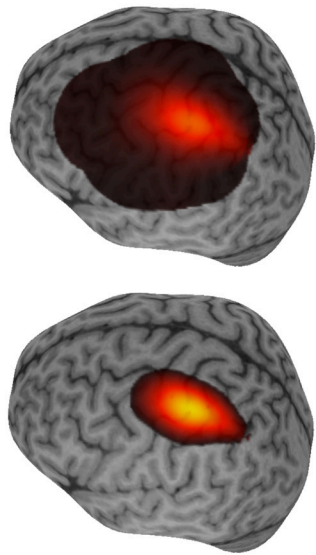

Fig. 19-7

Example of thresholded and non-thresholded MEP values. The appearance changes, however the underlying values remain the same.

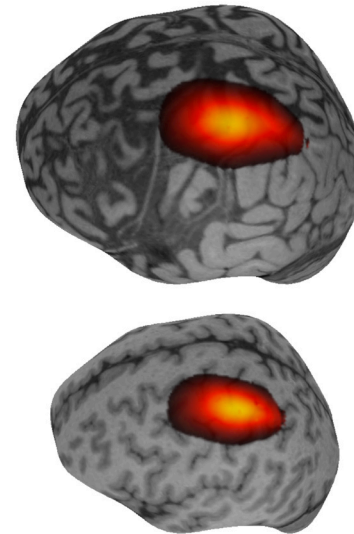

Fig. 19-8

Example of the motor map display at different curvilinear display depths.



Chapter 20: Special Application-EEG Recording

One of the most important trends in neuronavigation is integration with complimentary devices. One device where integration offers advantages is EEG. Adding EEG to neuronavigation, particularly in the context of EEG during TMS, offers new advantages including 3D localization of the electrode locations, real-time importing of the data synchronized to the TMS pulse and 3D visualization of the results along with the TMS coil locations. This chapter explains how to do this with the NEURO PRAX EEG system.

INTRODUCTION

Brainsight can communicate with the NEURO PRAX EEG system over a TCP/IP network. Both neuroConn (the makers of the NEURO PRAX) and Rogue Research have implemented a new protocol for communications between the two applications. We hope that this protocol will evolve to include various “like minded” devices and have the following features: 1: Auto-discovery on a local network. 2: Real time sharing of configuration information, status and experimental data as it is acquired. The heart of this protocol has been around for years. The basic implementation of our protocol uses the same tools that allow your computer to automatically discover your new printer, or for your iTunes® library to be shared over a network.

PERFORMING SIMULTANEOUS EEG/TMS RECORDING

Performing good EEG recording during TMS is still a bit of a challenge to do very well. With the NEURO PRAX hardware, it is relatively easy to acquire EEG data during TMS and to limit the artifact to under 20 msec. With a bit of care, that can be dropped down to about 5 msec. While the steps required for this are a bit beyond the scope of this manual, some of the key tricks are:

- Be meticulous in your electrode preparations. Clean and scrape the scalp well.
- Minimize loops in the EEG wires

The main steps to perform integrated EEG recordings

within Brainsight are:

- Connect both devices to the same local area network (LAN).
- Connect the TTL trigger out to both the Brainsight computer and the NEURO PRAX computer. You will need a TTL splitter (T connector) to share the trigger out.
- Use Brainsight normally until you reach the Session step.
- Use the NEURO PRAX normally to set up the subject, until you reach the measurement step.
- Configure Brainsight to enable EEG recording.
- Acquire the list of electrodes from the montage in NEURO PRAX into Brainsight.
- In the Electrodes step, use the pointer to record the electrode locations within Brainsight.
- Move to the coil placement step in Brainsight and set up your visualization preferences.
- Begin recording in the NEURO PRAX software.
- Perform your experiment and monitor as the data are recorded.

Connect the Brainsight and NEURO PRAX computer to the same LAN

Both computers need to be on the same LAN and have been assigned valid IP addresses (presumably from the DHCP server on your LAN). The NEURO PRAX computer supports the standard RJ45 Ethernet cable, while the

Fig. 20-1

Typical LAN configurations to connect the Brainsight computer to the NEURO PRAX computer.

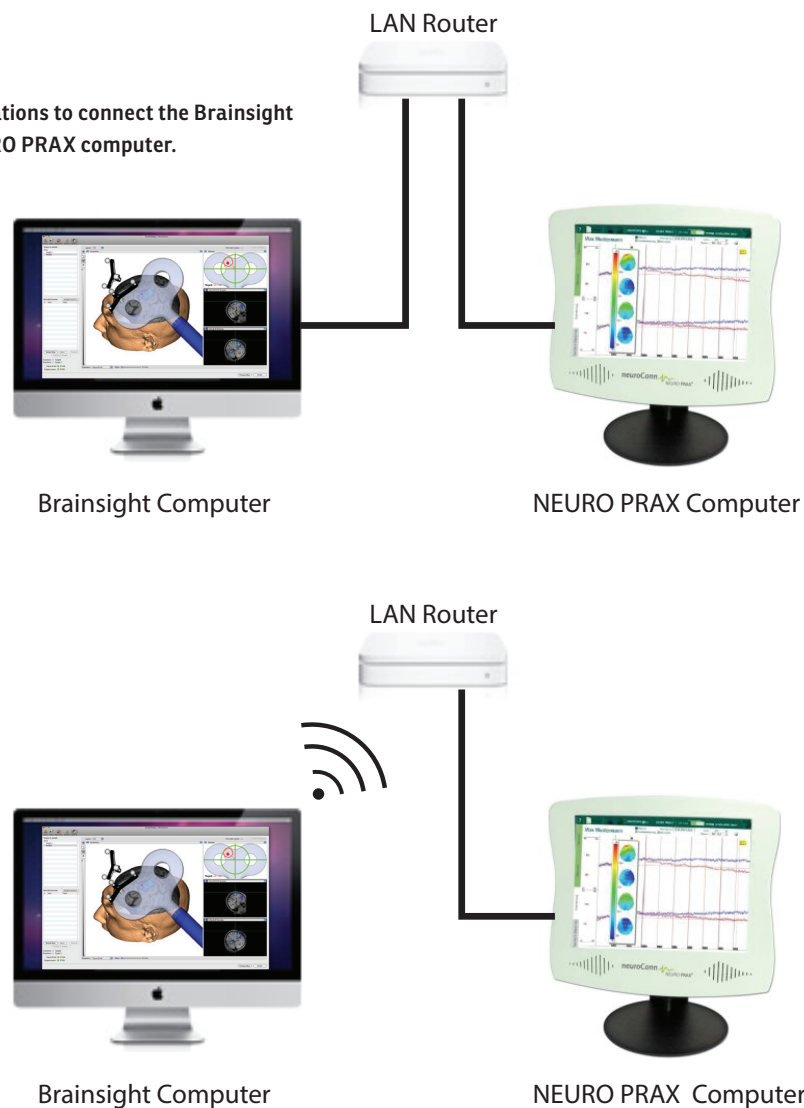

Brainsight computer supports Ethernet and WIFI. If your router also supports WIFI then either configuration illustrated in Fig. 20-1 will work.

Discovering Each Other During the TMS session

Set up both the Brainsight and NEURO PRAX systems as you normally would.

For the NEURO PRAX system, perform all the steps until you reach the measurement step (Fig. 20-2, upper screen). Click the measurement step. NOTE: You must be using a montage that has the ERP protocol enabled. Contact neuroConn for more details.

For the Brainsight procedure, perform all the steps up to and including the verify registration step. If your Brainsight licence supports EEG functionality, then you will notice an additional step in the session perform window called **Neuro Prax**, immediately after the verify registration step (see Fig. 20-2, lower screen).

Select the NeuroPRAX device from the popup button and click **Connect**.

If you connected the TTL trigger out from the stimulator to both the NEURO PRAX and Brainsight computers, DO NOT enable **Use NEURO PRAX input**. Otherwise, duplicate samples will be created, one when Brainsight receives the trigger from the stimulator, and another one when it receives the trial from the EEG computer. When it is not enabled, Brainsight will create the TMS sample when it receives the trigger from the stimulator, and then when it receives the EEG trial from the EEG computer, it

Fig. 20-2

Above: NEURO PRAX software in the “measure” mode.
Below: Brainsight NeuroPRAX discovery and connection step

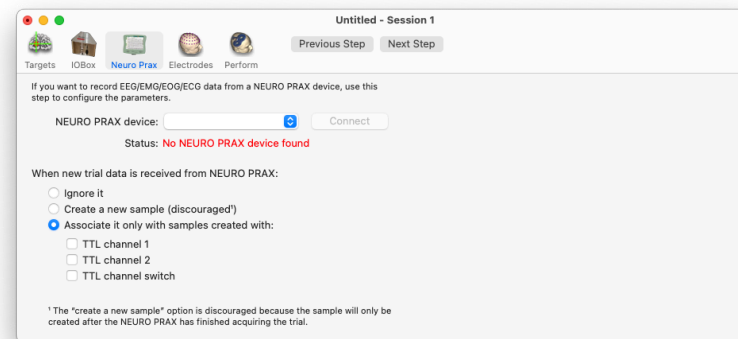
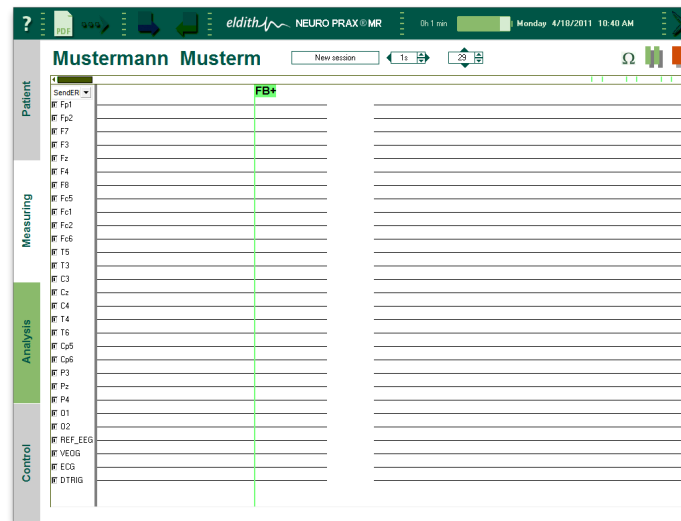

will associate that EEG data with the just created TMS sample. This ensures that the coil location is recorded at the time of the stimulation, and not at the end of the EEG trial acquisition.

If you only connected the TTL trigger to the NEURO PRAX computer, then enable **Use NEURO PRAX input**. During the experiment, each time the EEG system acquires an epoch of data (trial), it will automatically be sent to Brainsight and Brainsight will record the coil location and create a sample with it along with the EEG data. Note that there will be a delay between the time of the TMS pulse and the sample creation as Brainsight will only be notified of the sample after the EEG computer has acquired the sample and sent it to Brainsight. If the TMS coil is moved during that delay, the location of the coil at the end of the EEG trial (as opposed as at the time the coil was fired) will be recorded.

As the EEG is acquired, you can view the data in the Brainsight windows in a variety of ways. In any image view, you can select one of several EEG display methods. Take a moment to explore the different displays to find one that best suits your needs.

If the two computers have discovered each other, you should notice in the Brainsight Electrodes step window that the **Add From-> NEURO PRAX** item is enabled (Fig. 20-3). If not, make sure that the NEURO PRAX computer is in the measure step and verify that your network is properly configured. Contact Rogue Research for further assistance.

Fig. 20-3

Electrodes shown in the list populated from the NEURO PRAX (or loaded from a sequence file).

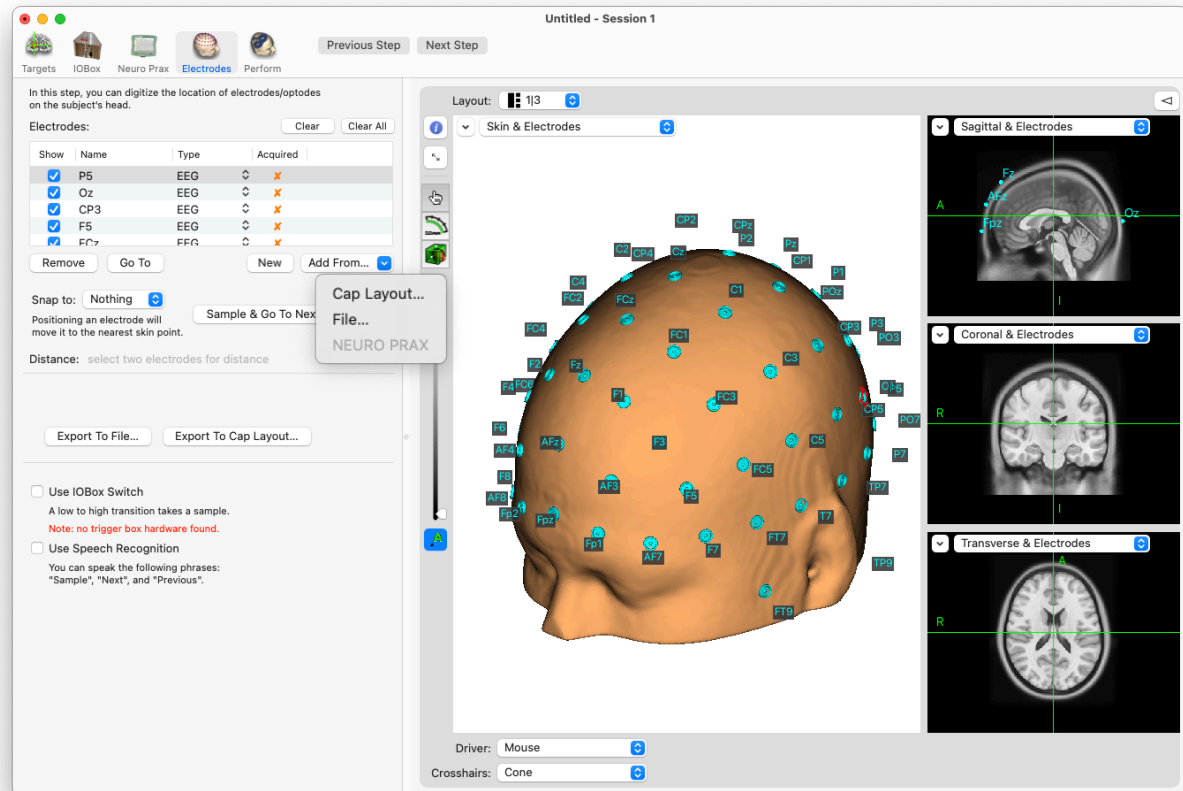

Digitizing Electrode Locations

Once the two systems have discovered each other, you can obtain the list of electrodes from the NEURO PRAX computer, and use the Brainsight pointer to digitize them.

- In the Brainsight electrodes step, click **Add from NEURO PRAX**. After a few seconds, the electrode list should fill up and match the electrode names on the NEURO PRAX computer. NOTE, if instead you received an error message, try going back and forth from the **Measuring to Patient** and back to **Measuring** mode on the NEURO PRAX computer, then click **Populate from NEURO PRAX** again (there is a known issue that the connection is interrupted after an extended period).
- Once the electrode list has been populated, record them with the pointer by touching the electrode highlighted in the list with the pointer, and clicking Sample and Go To Next. You can use the Apple Remote or Voice recognition to sample in the same way as described in “Configure the I/O or trigger Box” from Chapter 16.

Recording EEG data during the experiment

Once the electrode locations have been recorded, **Click Perform** to go to the next step. Follow the instructions from “Chapter 16: Performing the Study” to set up for the stimulation.

Exporting EEG Data

Once the experiment is complete and you are reviewing

the session from “Chapter 21: Reviewing Study Data”, you can export the EEG data to EDF+ format for processing in your favorite EEG analysis program. EDF+ is the most commonly accepted EEG file format and enables you to use the EEG data acquired in Brainsight for analysis using other software. Brainsight supports two variants of EDF+, the discontinuous (event related) and the continuous versions. Brainsight stores the data in an event related

format, so the continuous export is re-constructed using the timing information and the gaps between the samples (if there are any) are padded with 0s. To export the EEG data, (in the session review window), click **Export EDF+**, and follow the prompts.

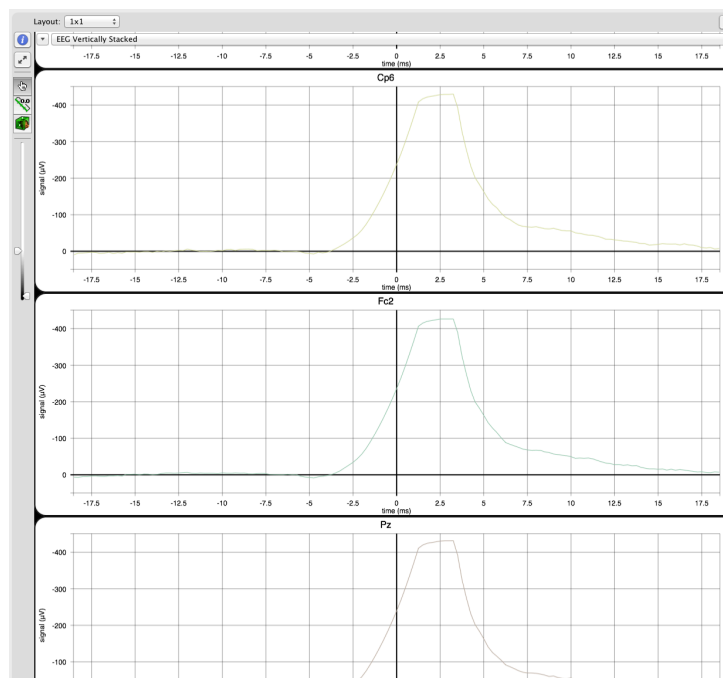

Fig. 20-4

One of the methods of displaying EEG data.



Chapter 21: Reviewing Study Data

After one or more TMS sessions, it is often useful to review the data acquired. Brainsight has several tools to help review the results of the TMS session as well as export these to external file formats so you can perform more detailed analyses.

The usual purposes for review are:

- To verify that the targets to be stimulated were indeed stimulated.
- To sort through the data and export relevant information for further analysis.
- To pick recorded locations and convert them to targets for subsequent sessions.
- To configure the display window and take screenshots for publication.

Review is initiated from the Session manager pane. Click on the Sessions tab and then click **Review**, which will open a new display window (Fig. 21-1).

DISPLAY WINDOW

The review display window uses a similar layout to the perform window with a few changes.

- A new list, the session list, can be seen next to the samples list. You can show or hide all the samples from a particular session as a group in the image views by enabling the **show** checkbox. You can show one or multiple sessions by clicking on their respective **show** boxes.
- The samples list displays all the samples from a session selected from the sessions list. Selecting multiple sessions in the sessions list will add all the samples from each highlighted session into the samples list. This is distinct from showing or hiding a sample in the image views. The samples list allows

Fig. 21-1

Session Review window.

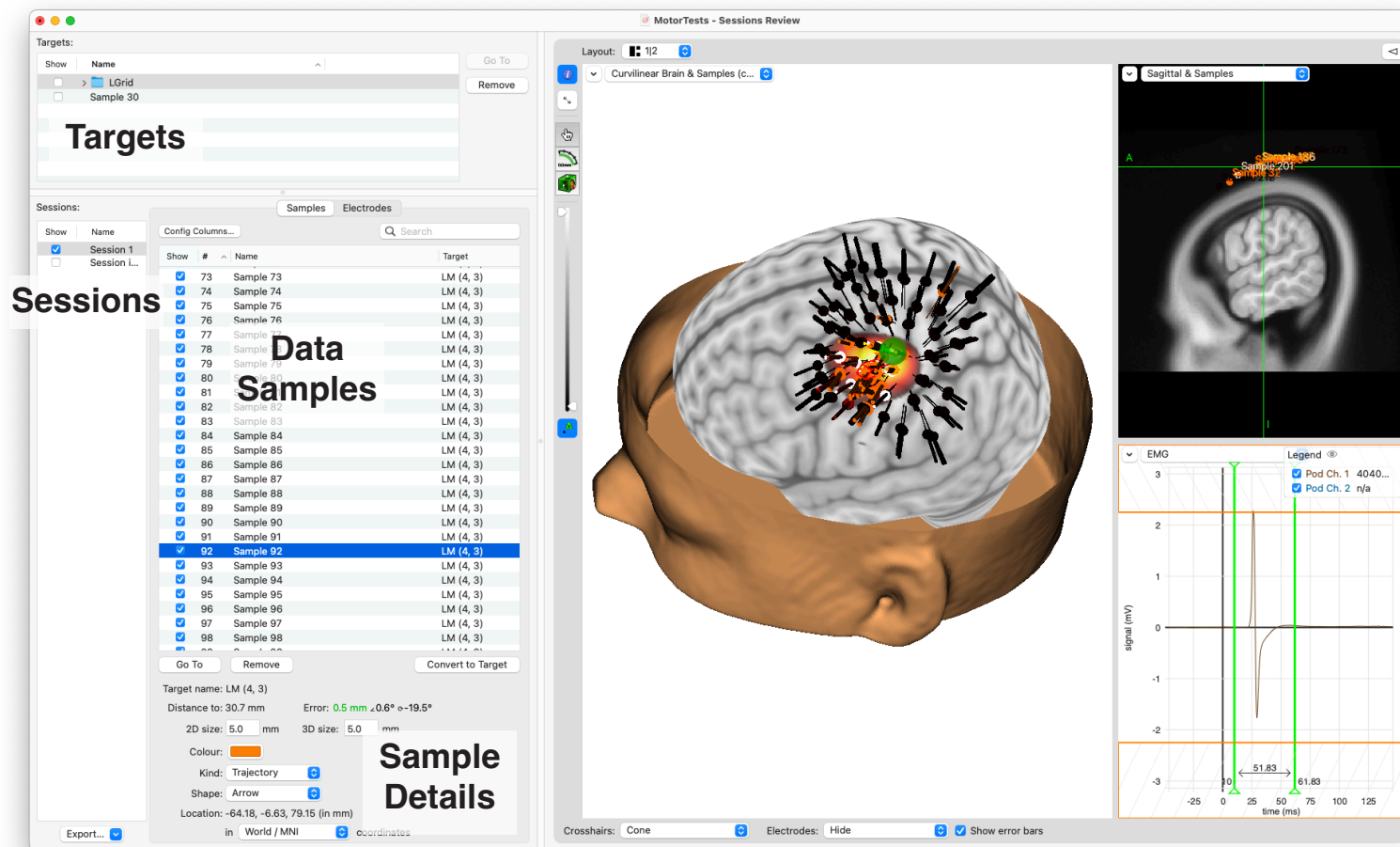

you to selectively view the attributes of one or more samples. Selecting another session in the sessions list will affect what is shown in the samples list, but not what is being displayed on the images. Clicking **Configure Columns...** opens a window where you can enable or disable the display of any attribute in the samples list to simplify sorting them.

- The target list will have all the targets created in this project. You can display any of the targets in the image views by enabling their respective **show** checkbox.

EXAMINING THE DATA AND CHANGING ATTRIBUTES

Samples can be made visible or hidden using the **show** checkbox. To show or hide all of the samples quickly, select any sample, press **⌘-a** to select the entire list (or shift-click or **⌘**-click to select a group from the list), then **cntrl-click** or **right-click** on the list and select **Show Selected Samples** or **Hide Selected Samples** from the popup button.

When a sample is selected (and visible on any of the image views), the sample will be highlighted by a red bounding box. When multiple samples are selected, each one is highlighted.

Selecting a sample in the samples list will display its attributes under the samples list. Many of these attributes were acquired when the sample was recorded, such as the current target at the time and the EMG waveform (if you were recording EMG). Many attributes are user selectable,

such as the colour and shape of the sample. These can be changed at any time. Selecting multiple samples will display the common attributes. Changing any of these will be applied to all the selected samples.

One noteworthy attribute to describe is the peak-to-peak response from the EMG. This value is not recorded but rather it is derived from the raw EMG sample and the EMG window set with the movable green lines in any EMG display. If you move the MEP window controls (see Fig. 16-16), the MEP values will be recalculated. You can also change the MEP peak to peak manually by selecting the value in the list, and editing it directly. This new value will be used in any subsequent motor map calculation and will be exported when the Data Export option is selected. This can be handy to remove outlier values known to be noise or to replace the values with values from a third party EMG device (and used to create a motor map display). Note the value is displayed in bold typeface when it has been overridden. Deleting the override value in the sample data list will return the value to the automatically calculated value.

The samples list represents a union of the samples from the selected sessions. You can manipulate content of the list display by clicking **Configure...**, and enabling and/or disabling the available fields. You can display the samples in the image views for comparison by clicking the show checkboxes in the lists. You can also change the display layout (as in any display window) to your preference by clicking in the list headings to change the display order.

As was possible during the TMS session, you have access to the inspector tool to customize the image view, change the display attributes of the 3D surfaces as well as use the motor maps feature.

CONVERTING A SAMPLE TO A TARGET

It is common for a TMS target to be derived from the results of a previous TMS session. You can easily convert (copy) a recorded sample into a target by dragging the sample from the sample list into the target list. The **Convert to Target...** button present while performing the TMS session performs the same function as dragging and dropping them.

It is common for the recorded sample locations to have a scalp point as its origin while it is often preferable to have the target's origin set somewhere in the cortex (see Fig. 15-10). After creating the target as described above, use the target positioning tool and nudge tool to nudge the target into the cortex as described in "Creating a target based on a previous sample" on page 103.

EXPORTING THE DATA

You can also export the targets or acquired sample data to a text file for more detailed analysis. The file format is essentially a tab-delimited text file where each row is a sample (or a landmark or target if you chose to export those as well) and each attribute is separated by a tab character. Attributes with multiple values are separated by a semicolon.

To export the data, select the samples you wish to export from the list, then click **Export...** to open the export dialog box (Fig. 21-2). You can choose to export the samples as well as the targets and registration landmarks. If you selected a sub-set of samples to export, click **Selected samples only**, otherwise, select ALL or None. Among the samples, targets and landmarks, you can select which attributes for each type of entry to export. You can also select the coordinate system to use for all coordinates. The default is World coordinates, which are defined by the image data file format. You can also select Brainsight's internal coordinate system (illustrated in Fig. 21-3). If you performed an MNI registration, you can use MNI or Talairach coordinates. Enter a file name (navigate to the desired folder), and then click **Save**.

Exported Data Format

The text file begins with a short header describing the fields and the order in which they are saved, followed by the targets (if you chose to export them), then the landmarks (if selected) and finally the samples. If you chose to export the landmarks, each one consists of two points (in the same coordinate space). The first is the image-based location (the one identified on the images in the landmarks step) followed by the coordinate sampled by the pointer during the registration.

Attribute description

All data are written as strings. It is described as an integer, it is implied that this is the format of the string.

Fig. 21-2

Data export box.

The selected attributes of each sample will be exported as a text file. The format is a straightforward tab-delimited text file.

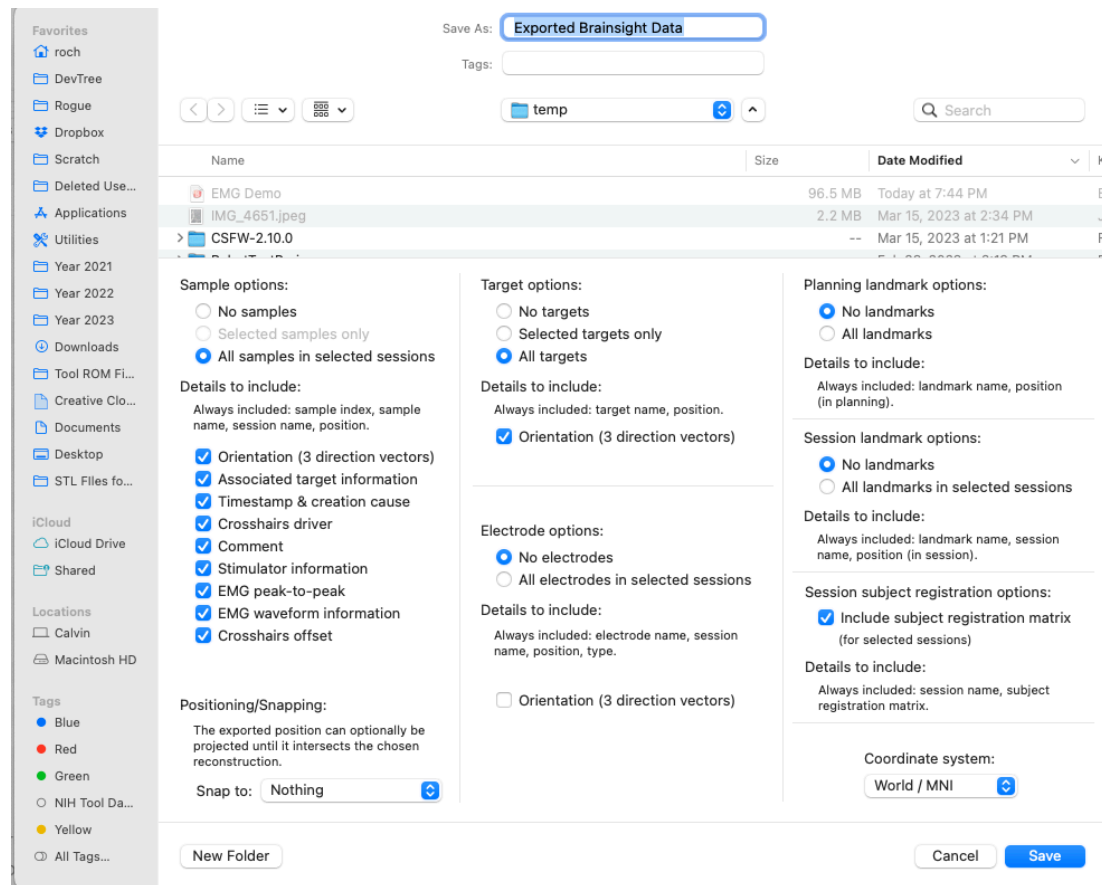
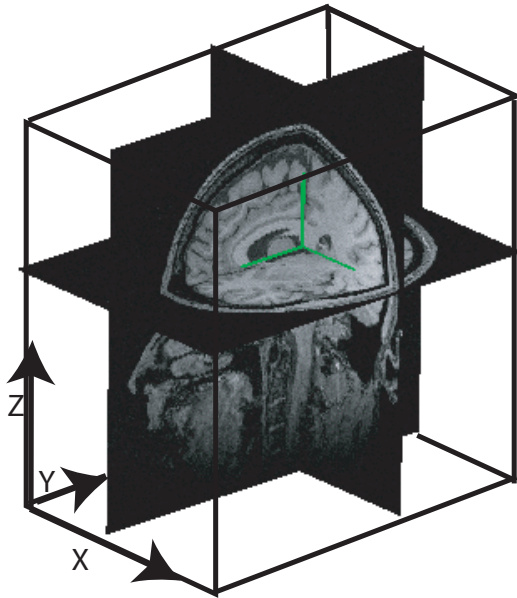

Fig. 21-3

Brainsight's internal coordinate system.



Note that some attributes were added with newer versions of Brainsight. If you are exporting a session that was acquired with an older version, the newer attributes may not be included since they were not recorded at that time.

- **Session name** [string.]: the name of the session.
- **Sample name** [string.]: the name of the sample.
- **Index** [integer]: The index of the sample assigned in the order of the creation of the samples. If samples are deleted after they were created, the indexes are not reused.
- **Creation Cause** [string]: The name of the event that caused the sample to be recorded (e.g. TTL1).
- **Assoc. Target** [string]: the name of the target that was current at the time of the sample.
- **Crosshairs driver** [string]: Name of the tool that was being tracked when the sample was generated. Possible values are Mouse, Pointer or the name of the tracked tool given when it was calibrated.
- **Lox X (Loc Y & Loc Z)** [float]. X, Y and Z values of the location of the tracked tool at the time the sample was taken.
- **m0n0 m0n1 m0n2** [float]: The orientation (direction cosine) of the x axis of the tracked tool in the host coordinate space. See Fig. 21-4 for a description of the tracked tool coordinate system and how to use the location and direction cosines to assemble the tool-to-image transform. This transform can be used to convert points relative to the tool to points in the image space (e.g. projections along the coil's z axis into the head).
- **m1n0 m1n1 m1n2** [float]: The orientation of the y axis of the tracked tool in the host coordinate space.
- **m2n0 m2n1 m2n2** [float]: The orientation of the z axis of the tracked tool in the host coordinate space.
- **Offset** [float]: The value of the offset slider (set during the session in the perform window) when the sample was acquired.
- **Comment** [string]: The comment that was entered (if any) in the comment field of the sample.
- **Dist. to target** [float]: The straight line distance from the coil reference point to the target.
- **Target Error** [float]: The shortest distance from the line projecting into the head along the coil's path as described in Fig. 16-18.
- **Angular Error** [float]: The tilt error of the coil as described in Fig. 16-18.
- **Twist Error** [float]: The angular difference between the target orientation and the coil's orientation. The centre of rotation is the Z vector as defined during the coil calibration (see Fig. 7-7).
- **Date** [string]: The date the sample was acquired in YYYY-MM-DD format.
- **Time** [string]: The time (according to the system

clock) in HH:MM:SS.XXX where HH is the hour, MM is the minute, SS is the second and XXX is the millisecond.

- **Stim. Power A, Pulse Interval, Power B:** When connected to a Magstim 200 or bi-stim using a serial cable, these values may be captured and exported.
- **EMG Window Start & EMG Window End** [float]: The values of the window start and end in which the MEP value and latency are evaluated.
- **EMG Start** [float]: Time in msec before the sample time (e.g. when the coil fired) when the EMG recording started. Also referred to as baseline. Always a negative number.
- **EMG End** [float]: End time in msec of the EMG sample (trial duration).
- **EMG Res.** [float] Time in msec between samples.
- **EMG Channels** [integer]: Number of active channels at the time of the sample acquisition (usually 0, 1 or 2). Note that value can change within a session (if one changes the settings during the session).
- **EMG Peak-to peak N** [float]: N is the channel number. Peak to peak value in μV calculated between the EMG window at the time the data was exported. Note that for multiple EMG channels, the order of the data output is: EMG Peak to Peak 0, EMG Data 0, EMG Peak to Peak 1, EMG Data 1 and so on.
- **Latency** [float]: The time from the TMS pulse to the

start of the EMG response.

- **EMG Data N:** [float;float;...float]. EMG samples in μV , separated by a ";". The number of samples can be calculated by **(EMG End-EMG Start)/EMG Res**

You can perform the export more than once and switch coordinate systems between exports to export the data in multiple coordinate systems.

EXPORTING TO DICOM FORMAT

If your anatomical images were in the DICOM format, you can export the TMS samples in a more graphical manner for use in other visualization software (or even another navigator) by exporting them in DICOM format. The exported images can either be a copy of the original anatomical images with the EMG values "burned" onto the images as a sphere using the EMG values and the projection of the TMS coil vector onto an arbitrary surface (e.g. curvilinear) as the location, or a blank volume with the same geometrical size/shape as the underlying anatomical images for use as an overlay.

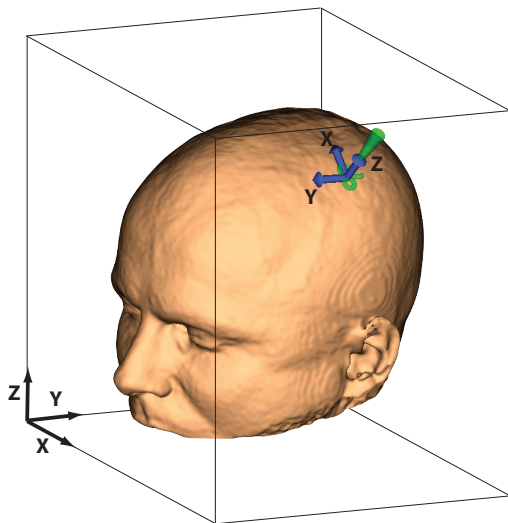

excerpt from export

... Loc.X Loc.Y Loc.Z m0n0 m0n1 m0n2 m1n0 m1n1 m1n2 m2n0 m2n1 m2n2 ...

$$\begin{bmatrix} m0n0 & m1n0 & m2n0 & \text{Loc } x \\ m0n1 & m1n1 & m2n1 & \text{Loc } y \\ m0n2 & m1n2 & m2n2 & \text{Loc } z \\ 0 & 0 & 0 & 1 \end{bmatrix} \cdot \begin{bmatrix} X_{\text{coil}} \\ Y_{\text{coil}} \\ Z_{\text{coil}} \\ 1 \end{bmatrix} = \begin{bmatrix} X_{\text{bs}} \\ Y_{\text{bs}} \\ Z_{\text{bs}} \\ 1 \end{bmatrix}$$

Fig. 21-4

Illustration of the relationship between the coil position and orientation described by the loc and direction cosine values. They can be assembled into a matrix to convert coordinates relative to the coil into Brainsight, world or MNI/Talairach coordinate spaces. For example, to find the Brainsight coordinate of a point 15mm under the coil, multiply the transform matrix by the vector [0, 0, -15, 1] (Note, this example applies if the .txt file was exported in Brainsight coordinates).



Chapter 22: EEG Electrode Recording

Many Brainsight users also happen to use EEG for many of their experiments. If you are one of them, then you can make more productive use of your Brainsight position sensor hardware to digitize the locations of the EEG electrodes and the subject's scalp. This often renders the need for the Polhemus system (and the Locator software) redundant.

There are literally dozens of EEG data acquisition and analysis programs in use today. Some of these use standardized configurations of the EEG electrodes (e.g. 10-20 grid) to estimate the locations of each electrode. Other programs use a 3D position sensor (not unlike the Vicra used by Brainsight) to digitize the exact locations of the electrodes and sometimes the scalp to either create a more realistic model of the head, or to co-register the EEG data to MR images of that subject. In addition to EEG, many NIRS-DOT systems employ the same techniques to localize the NIRS optode locations.

Brainsight supports two methods to represent the EEG electrodes. One is a free form method where the three anatomical landmarks are recorded, followed by the electrodes in no particular order. The second method uses a sequence file (commonly used by BESA) to define a sequence of electrodes that can be loaded to prompt you to digitize the electrodes in that order. In either case, you may also want to digitize a random sampling of scalp points to characterize the shape of the head.

It is important to note that you do not need the MR images of your subject for this procedure. Strictly speaking, you are not performing any neuronavigation, you are simply using Brainsight to talk to the position sensor and take some measurements.

Once the measurements have been taken, you can save them in one of a few file formats, depending on the accepted formats of your EEG software.

GETTING STARTED

- Launch Brainsight and dismiss the splash screen. To open the EEG window, select **Window->Electrode Recording** (Fig. 22-1). Enter the name of the subject in the field at the top of the window.

Setting up

- Before starting, set up the trigger method(s) to notify the computer whenever you are touching a landmark. Optionally turn on the speech recognition or Apple Remote by enabling or disabling their respective checkboxes.
- Put the subject tracker on the subject's head and place the subject in the view of the Polaris position sensor (review how to prepare the subject and use the Polaris by looking at "Prepare the Subject" on page 113).

USING A TEXT FILE

- If you are using a text file (Sequence .seq, Locator .elp, BESA .sfp or Brainsight .txt), load it here by clicking **Import File...**, and select the file using the file dialog box. Refer to your EEG software documentation regarding the file format specification or contact Rogue Research for an example file. Once the electrode file has loaded, the electrode references will appear in the **Landmarks** and **Electrodes** tab (when you get to the next step). Note that loading a sequence file clears any pre-existing samples.

Fig. 22-1

First step of electrode recording.

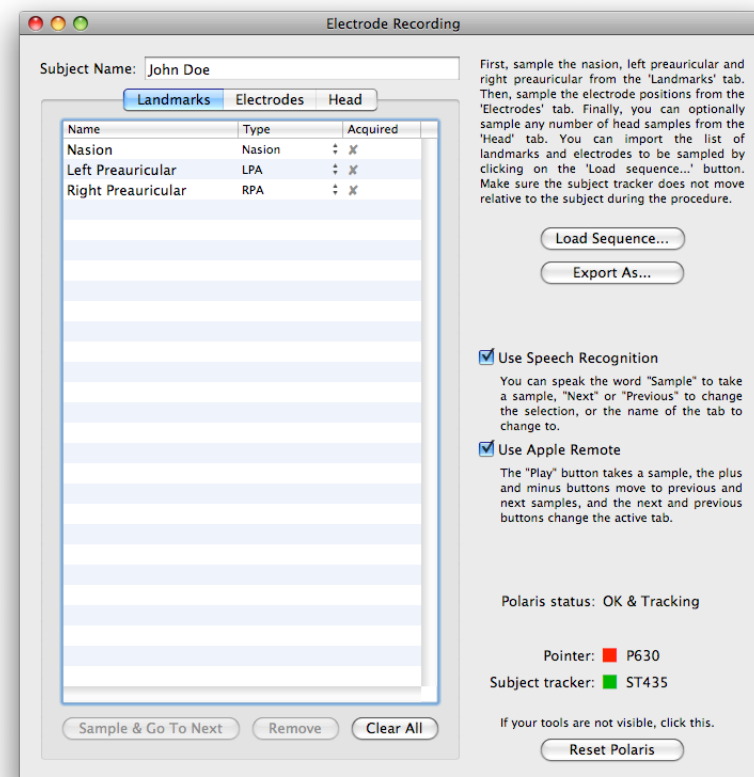

DIGITIZE THE ANATOMICAL LANDMARKS

- If not already the active tab, click the **Landmarks** tab to bring it up (or, if you have speech recognition activated, say “Landmarks”).
- Place the tip of the pointer on the first landmark and either say “Sample”, press **Play** on the Apple Remote or have an assistant click on **Sample & Go To Next**. The software will sample the location of the pointer and associate it with the currently selected landmark in the list. The green check mark confirms this.
- If there is another landmark, the software will automatically go to the next one and speak the name of the electrode (assuming you have the volume turned up). Take note of this, and touch it with the pointer and repeat the sample process.
- Continue for all landmarks.

Once you sample the last landmark, no landmarks will be selected. If you wish to add additional landmarks, continue to sample landmarks (as you did before) and new unnamed ones will be created. You can change the names as you go, or select them in the list after you have finished and rename them at that time.

You can re-sample a landmark by selecting it in the list and sampling it with the pointer again. You can remove entries by selecting them in the list and clicking **Remove**. Finally, you can clear all the samples by clicking **Clear All**, which removes the sampled data but leaves the entries so they can be re-sampled.

Fig. 22-2

Electrode digitizing screen

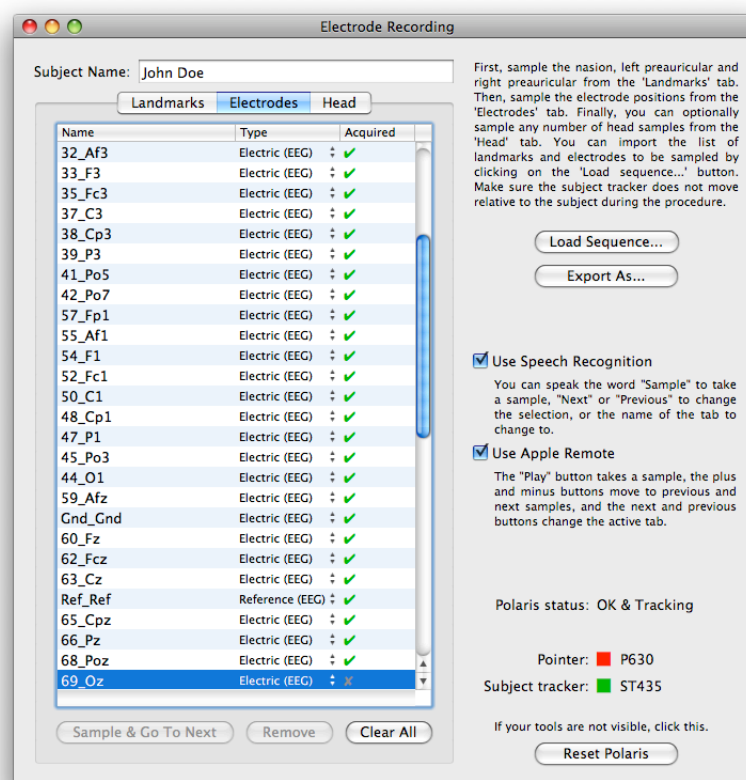

DIGITIZING ELECTRODES

- Click on **Electrodes** or say “Electrodes” to bring up the electrodes tab (Fig. 22-2). If you are using a sequence file, then all the electrode names should be visible in the list. Otherwise, the list will be empty and any new sample will automatically be named “Electrode-1, Electrode-2...”.
- Touch the first electrode (either the one highlighted in the list, or if there are no entries in the list, your first electrode) and either say “Sample”, press **Play** on the Apple Remote or have an assistant click on **Sample & Go To Next**. The software will sample the location of the pointer and associate it with the currently selected electrode in the list.
- If there is another electrode, the software will automatically select the next one in the list and speak it. Go to the named electrode location, touch it with the pointer and sample the location.
- Continue for all electrodes.

Once you sample the last electrode, no electrodes will be selected in the list. If you wish to add additional electrodes, continue to sample them (as you did before) and new unnamed ones will be created. You can change the names as you go, or select them in the list after you have finished and rename them at that time.

You can re-sample any electrode by selecting it in the list and sampling it with the pointer again. You can remove an entry by selecting it in the list and clicking **Remove**. Finally, you can clear all the samples by clicking **Clear**

All, which clears the sampled data, but leaves the entries so they can be re-sampled.

DIGITIZING HEAD SHAPE (OPTIONAL)

The purpose of the head sampling function is to generate a “cloud” of samples that will help define the shape of the scalp. This is used by many EEG applications to generate a subject specific head model or to co-register the EEG electrode coordinate space to the subject’s MR space.

To begin acquiring scalp samples:

- Click on **Head** or say “Head” to bring up the Head sampling tab (Fig. 22-3). Note that the list will be empty as there are no pre-defined head points.
- Touch the pointer tip gently on the subject’s scalp, making sure that the pointer is visible to the Polaris and either say “Sample”, press **Play** on the Apple Remote or have an assistant click on **Sample & Go To Next**. The scalp location will be recorded and the entry will be appended to the list in the window.
- Move the pointer tip to an adjacent location on the scalp and sample again (using the same options as in the previous step).
- Continue to sample scalp locations throughout the head according to the needs of your EEG software. Typically, at least 20-30 points will be required. make sure that you obtain samples all over the head to obtain a reasonably good representation of the head shape.

SAVING THE DATA

Once you have sampled the anatomical landmarks, electrode locations and head shape cloud (if needed), you can save this information to a variety of file formats.

- Click **Export As...** to open the save file dialog (Fig. 22-4).
- Select a file format from the popup menu (see below), enter a file name and click **Save**.

FILE FORMAT DETAILS

The file format chosen for export will influence two things: the format of the text and the coordinate system of the samples. Choose the right one for your EEG software. **Take special care to fully understand the coordinate system used for each format as they can be confusing!**

Text (.txt)

This is the simplest file format. The coordinate system uses the subject tracker as the origin and the coordinate axes, which are arbitrary depending on the orientation of the subject tracker. All samples are in this coordinate system. The coordinate system details are irrelevant as the anatomical samples would presumably be used to co-register all the samples to your specific coordinate system.

Locator

The coordinates are transformed according to the Locator coordinate system (sometimes referred to as the CTF

Fig. 22-3

Head Sampling Screen

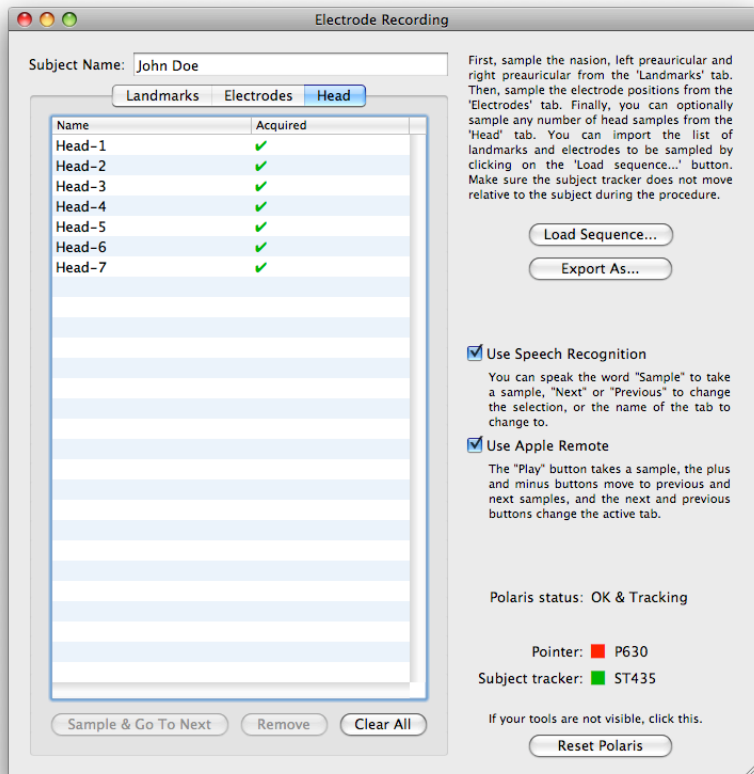
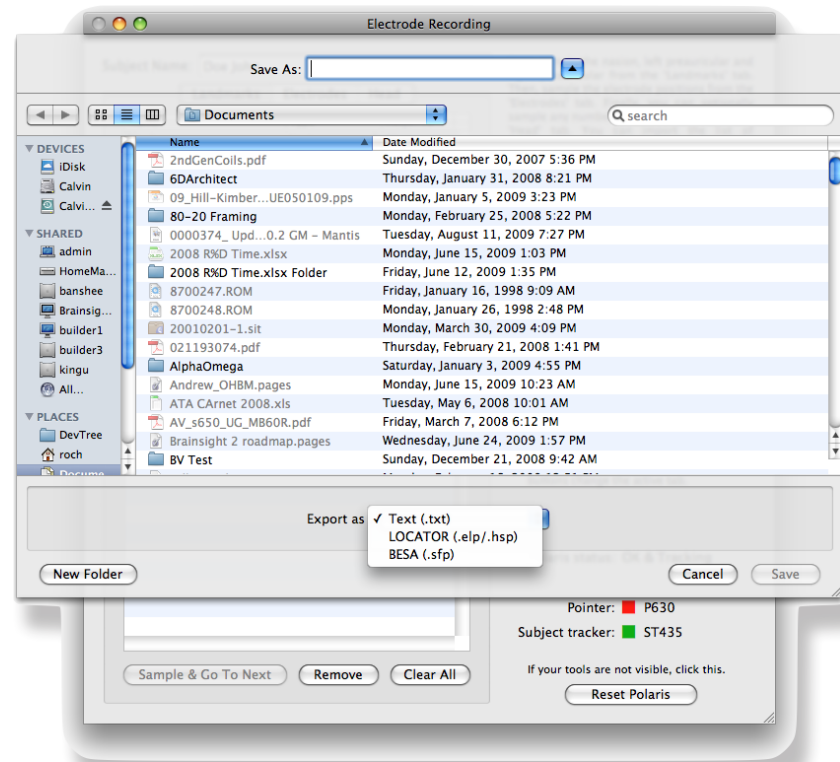

Fig. 22-4

File Export Dialog



coordinate system). In short, the X axis is defined as the line starting at the midpoint between the RPA and LPA and passing through the nasion. The Z axis is taken as the cross product of the X axis and the RPA-LPA line and the Y axis is the cross product of the Z and X axes, which is close, but not necessarily exactly along the RPA-LPA line.

BESA

The BESA file format structure is similar the Locator, except that the coordinate system is slightly different (and sometimes confused with the Locator coordinate system!).

The origin is the point along the LPA and RPA line where the line from that point to the nasion would be perpendicular to the LPA-RPA line (near the middle, but not necessarily exactly the middle due to head assymetry).

The X axis is along the LPA-RPA line. The Y axis goes from the origin to the nasion and the Z axis is the cross product of the X and Y axes.

MatLab

Details to come.

As more Brainsight users become familiar with EEG, we would be happy to include additional file formats to the list. Please do not hesitate to contact us.

Chapter 23: Assembling the MRI Camera Stand

While many NIBS experiments take place in dedicated rooms, there is a growing interest in performing NIBS while simultaneously scanning the brain using fMRI to observe changes in brain activation in real time. While this is an exciting prospect, it does impose significant logistical challenges to perform well. One requirement is to have all hardware (trackers, position sensor camera and camera stand) that is MRI compatible. MRI compatibility means meaning that it has no ferromagnetic materials to risk pulling the stand into the powerful magnet and to minimize any electromagnetic interference that may be caused by the camera. This chapter will cover assembly of the MRI compatible position sensor stand for the NDI Vega or Spectra.

NOTE: While every effort is made to ensure hat the equipment is safe and effective while used in the MRI scanner, Northern Digital (the manufacturer of the Vega and Lyra cameras) do not guarantee MRI compatibility. Suitability for this purpose has been reported by other users however suitability and safety of these devices must be established on a case by case basis by you, the end user.

PARTS LIST:

1x 13mm wrench (NOT MRI COMPATIBLE)

6x 810mm Aluminum Extrusion

2x 1035mm Aluminum Extrusion

1x 585mm Aluminum Extrusion

4x 6-hole plate joint

4x L-joint

2x T-joint

2x Plastic 90deg Gusset

94x Brass Bolts (or 74 & 20 with thumb screw)

94x brass nuts

84 Plastic washers (spacers)

20x 3-hole Nut Spacer

12x 2-hole Nut Spacer (or 4 & 8 with set screw)

9x 1-hole Nut Holder (or 7 & 2 with set screw)

2x End-cap with wheel

2x End-cap with foot

4x flat bar end-cap

1x Camera Bracket
4x 4mm x 16mm bolts

2x Ethernet-Optical converter
1x Optical cable
1x Ethernet Cable

ASSEMBLING THE FRAME

Assemble the nut spacers first by inserting the nut into the hexagonal holes (Fig. 23-1). Note that the bolts are held by friction so handle them with some care to prevent the bolts from falling out. The purpose of the spacers is to keep the bolts spaced to match the hole spacing of the L-bracket and T-joint and to facilitate assembly by keep the bolts oriented correctly. When inserting the spacers with nuts, you may find they slide well with slight resistance to hold their position within the T-slot tracks (this is the intention) however due to the variability of the slot thicknesses, they may have high resistance and be difficult to slide, or may have little resistance and move when the bar is tilted. You can use a small piece of tape to hold them in place if needed.

Note the shape of the profile when looking at the end (Fig. 23-2B). One side is flat while the other is trapezoid. This is designed to fit into the similarly shaped slot in the aluminum extrusions (Fig. 23-2B).

1. Take 84 of the plastic spacers and insert them onto 84 of the brass bolts (Fig. 23-3).



Fig. 23-1

Example of a 3-nut spacer with the nuts inserted

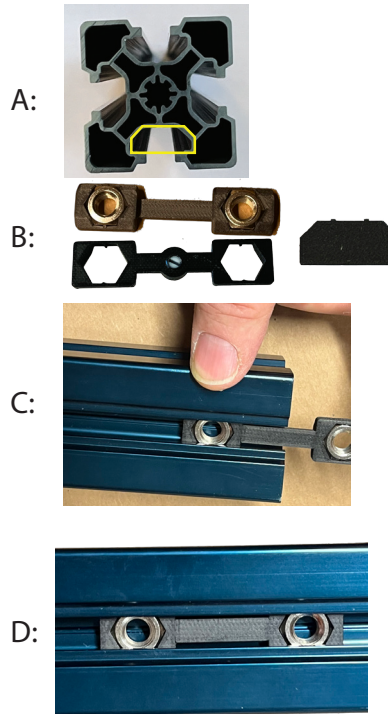

Fig. 23-2

A: The aluminum extrusion profile (slot profile highlighted).
B: Example of a 2-nut spacer with and without set screw.
C: Spacer being inserted into extrusion slot.
D: Spacer fully inserted.

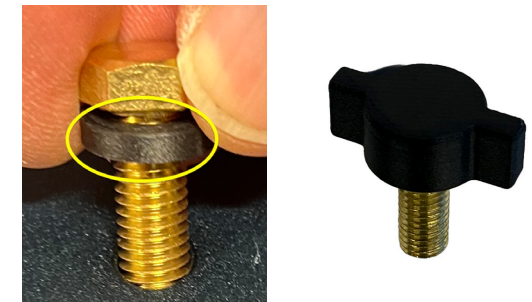

Fig. 23-3

Brass bolt with plastic spacer (highlighted) and thumbscrew (without spacer).

2. Take 2 of the 810mm aluminum extrusions and insert a 3-hole spacer at one end of each of them (refer to Fig. 23-2 to see how to insert a nut-spacer).
3. Lay the extrusions flat on the floor such that the ends with the spacer are next to each other (so the 2 extrusions, when joined, form a longer extrusion, refer to Fig. 23-4).
4. Take a 6-hole flat joint plate and lay it over the bars and adjust the position of the bars so the holes of the joint plate align with the holes of the 2 3-nut spacers in the extrusions.
5. Using 6 brass bolts (with spacers), insert them into the holes of the plate and crew them into the 6 brass bolts in the extrusions. The two extrusions should now form one long extrusion with the 6-plate joint at the half-way point.

6. Flip the extrusions over so the 6-hole plate is on the floor and the bare sides of the extrusions are on top.
7. Repeat steps 2-5 to secure a second 6-hole plate to sandwich the extrusions with the 2 plates. The result should look like Fig. 23-4.
8. Repeat steps 2-7 with 2 additional 810mm extrusions and 2 6-hole plates to make a second extended extrusion assembly. These will form the



Fig. 23-4

2x810mm vertical bars attached at the ends with 2x 6-hole joint plates

two vertical sections of the stand (vertical bar assembly).

9. Take the first of the vertical bar assemblies and insert 2x 3-hole spacers into one slot of the bar, 90 degrees rotated compared to the joint plates assembled earlier (see Fig. 23-5). Slide the first of the 3-hole spacers about 16" (406mm) down from the top and have the second one end flush with the top of the bar.
10. Insert 2x 3-hole spacers into the slot opposite from the one of the previous step so that they are on both sides of the vertical bar.
11. Take one T-joint plate and align the bottom 3 holes with the lower 3-hole spacer nuts, and using 3x bolts with spacers, attach the T-joint to the vertical bar assembly. Repeat with a second T-joint plate of the opposite side of the bar. Do not over tighten (just enough to keep the T-joint from moving).
12. Take one L-joint plate and align 3 holes with the 3-hole spacer at the top of the vertical bar assembly, orienting the L-joint such that the final result should look like Fig. 23-5. Repeat with a second L-joint plate for the opposite side of the vertical bar. Do not over tighten (just enough to keep the T-joint from moving).
13. Repeat the previous 4 steps for the second vertical bar assembly however point the joint plates in the opposite direction (see Fig. 23-6).



Fig. 23-5

Upper section of the vertical bar assembly with the T-joint and L-joints in place.



Fig. 23-6

Vertical bar assemblies with upper joint plates installed.
Note the joint plates are oriented to face each other.

14. Take one 810mm aluminum extrusion bar and insert a 3-hole spacer into one of the slots at one end and slide it to the middle of the bar, approx 40cm from one end. Insert a second one into the opposite side of the bar and slide it to the middle of the bar.
15. Take one T-joint plate and place it over one of the 3-hole spacers (that you inserted into the bar) and using 3x brass bolts (with spacers), screw the bolts into the 3 bolts within the spacer (Fig. 23-7). Tighten the bolts gently to leave them loose enough to enable the T-joint plate to be slid along the bar to adjust the final position. Note that sliding the T-joint may be difficult as it may bind. Adjust the tension in the 3 bolts to enable the plate to slide with little effort (it takes practice).

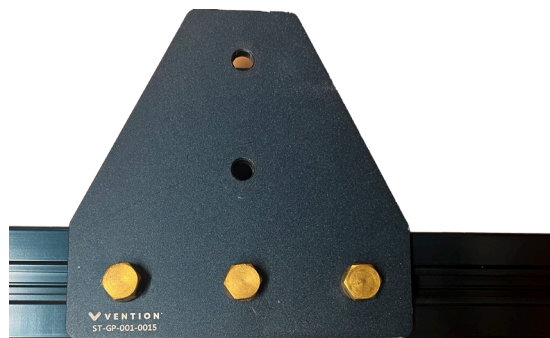

Fig. 23-7

T-joint plate attached to the aluminum profile.

16. Take another T-joint and screw it into the opposite side 3-hole spacer so that the 2 T-joint plates are parallel to each other.
17. Repeat the previous 2 steps with a second 810mm aluminum extrusion bar. Note that these will form the horizontal base (feet) of the stand.
18. Take one of the vertical extrusion assemblies, and 2 2-hole spacers. Insert one spacer into a slot at the opposite end of the bar than the L-joints, taking care to insert it into one of the other 2 slots (not the same slots used for the L-joints) so they are at 90-degrees compared to the L-joint. Slide that spacer to be flush with the end of the bar.
19. Insert a second 2-spacer into the opposite slot, again flush with the end.
20. Place one 810mm (the feet of the stand) flat on the ground with the T-joints facing upward, and with an assistant helping, carefully insert the end of the extrusion assembly (vertical section of the assembly) bar with the 2-hole spacers in between the T-joint plates and align the 2 holes of the T-joint plates with the bolts of the 2-hole spacer, and insert 2 bolts (with spacers) to attach the vertical assembly to the 810mm bar (feet of the stand), taking care to ensure that the L-joints at the other end are pointing perpendicular to the 810mm bars and to leave the bolts a little loose to allow for movement of the bar (and the now attached 2-hole spacer).

21. Use 2 more bolts (with spacers) to secure the other T-joint. You may have to move the bar somewhat to align the bolts.
22. With the 4 bolts inserted (in pairs) successfully, carefully slide the assembly bar down until it comes into contact with the perpendicular 810mm bar. Tighten all the bolts to secure the 2 bars in place.
23. Repeat the previous 4 steps for the second vertical assembly and 810mm bar.
24. Take one 1035mm bar, insert 1x 1-hole spacer nut (with the set screw, if present in your set) and slide it to the middle. Use a small flat-head screw driver to tighten the set screw to secure the T-nut.
25. Take one plastic 90-deg gusset and note that it has perpendicular slots (one horizontal and one vertically oriented). Using a brass bolt or bolt with thumb screw if present in your kit (No spacer ring), attach the L-bracket to the bar (see Fig. 23-8).
26. Repeat for the second 1035mm bar, taking care that the 90-deg gussets are both at the same locations along their respective 1035mm bars.
27. Take one 1035mm bar, insert one 2-hole spacer (with set screw, if present in your kit) into the end, ensuring you insert it in the same slot as the L-bracket from the previous steps. Insert a second 2-hole spacer (with set screw, if present in your kit) into the end of the bar using the opposite slot. Slide them to be flush with the end of the bar.

A:

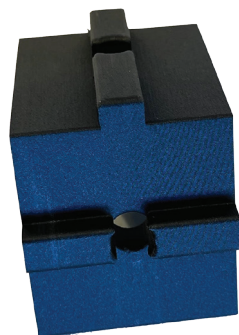

B:

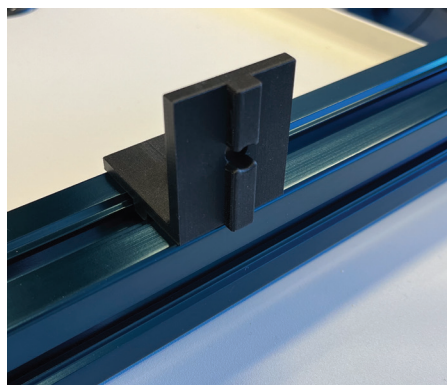

Fig. 23-8

A: 90-deg gusset with perpendicular slot guides.
B: Gusset installed on horizontal aluminum bar.

28. Insert 2x 2-hole spacers into the opposite end of the bar (with set screw, if present in your kit).
29. Repeat the previous 2 steps for the other 1035mm bar, ensuring both 90-gussets (one on each bar) are on the same side and the exposed slots of the gussets are parallel to each other (they will eventually secure the final extrusion between the two parallel 1035mm bars).
30. Take one of the vertical/foot bar assemblies and lay it flat on the ground with the ends of the T-joint and L-joint facing upward.
31. Take one 1035mm bar and insert it between the T-joints. Move the bar until the two holes of one T-joint is aligned with the nuts in the 2-hole spacer.
32. Use 2 bolts (thumbscrews, if present in your kit) and 2 spacers to secure the 1035mm bar to the T-joint, taking care to leave the bolts slightly loose to allow some movement for the next step.
33. Move the 1035mm bar slightly to align the 2 holes of the opposite T-bracket with the other 2-hole spacer. Insert 2 bolts (thumbscrews, if present in your kit) and 2 spacers into those two holes.
34. Push the 1035mm bar until it is in contact with the vertical assembly (perpendicular). If your kit does not have the t-nuts with set screws, tighten the bolts.
35. If your kit has the t-nuts with the set screws and thumbscrews, carefully remove the thumbscrews and carefully remove the bar taking care to not

- move the t-nuts inside the slots of the bar.
36. Using a narrow flat screw driver, tighten the set screws of the T-nuts to secure them in their now optimal location within the slot. Place the bar back into the bracket and replace the thumbscrews into the holes and tighten them.
 37. Repeat the previous 6 steps for the second 1035mm bar and the L-bracket at the end of the vertical assembly.
 38. With the aid of an assistant, take the second vertical bar assembly and hold it over the top ends of the 2 1035mm bars that are now attached the first vertical bar assembly.
 39. Carefully lower the assembly such that the 1035mm bar at the end of the assembly lines up with the L-joint and the second 1035mm bar lines up with the T-joint. You may have to adjust the location of the T-joint to get everything to line up.
 40. Secure all the joints using thumbscrews or bolts (with spacers). A total of 16 bolts will be needed (8 for each 1035mm bar).
 41. Orient the entire frame upright (so the 2 810mm bars that form the feet are flat on the ground).
 42. Using the wrench again, ensure that all the bolts of all the joints (T-joints and L-joints) are well secured and that stand does not sway left/right (some flex is inevitable, but it should feel secure).
 43. Take the short 585mm bar, and insert two 1-hole

nut holders into the same slot of the 585mm bar. Slide the spacer such that they are the same distance apart as the 2 gussets on the 1035mm bars (~16" apart)

44. Align the 585mm bar vertically and align the free hole of the upper gusset with the upper bolt in the slot of the 585mm bar. Secure the 585mm bar to the gusset with a bolt (no spacer). Keep the bolt loose enough to allow the 585mm bar to slide vertically.
45. By sliding the 535mm bar vertically, align the lower



Fig. 23-9

Closeup of the sliding Vega stand.

gusset with the other 1-hole nut holder and secure with a bolt (no spacer).

46. Take one 1-hole nut holder and insert it into one of the slots of the 585mm bar (either one of the left-right side slots), slide it down ~10cm from the top (does not need to be exact). Take a second 1-hole nut holder and slide down the opposite slot (again ~10cm down).
47. Take the camera mount, and insert it into the vertical bar and side it down into one of the bolt holes in the middle is aligned with bolt in the slot (inserted in the previous step). See Fig. 23-9.
48. Insert a bolt (no spacer) and tighten the bolt slightly. Note that loosening the bolt slightly allows the camera holder to slide vertically on the 585mm bar.
49. Slide the camera mount until the second hole aligns with the opposite nut holder and insert another nut (no spacer).
50. Insert one 1-hole bold holder into the outer slot of one of the 810mm bars that are the foot of the stand. slide it ~2cm from the end.
51. Take one of the end-caps with wheels and insert it into the end of the 810mm bar. Slide it along the bar until the screw hole on the side of the cap is aligned with the bolt in the slot. Insert a bolt (no spacer) into the hole and screw into the bolt in the slot, leaving it slightly loose.
52. Slide the end-cap further onto the 810mm bar until

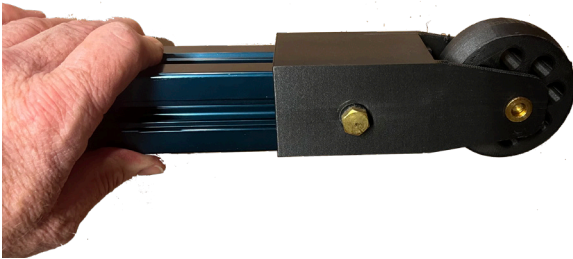

Fig. 23-10

Closeup of the foot with wheel.

the bar is just near the wheel, taking care not to slide too far such that the 810mm bar comes into contact with the wheel. Tighten the bolt to secure the end-cap (Fig. 23-10).

53. Repeat the previous 3 steps for the second end cap with wheel, taking care to have both end caps with wheels on the same end of the same, so the frame can be moved by lifting the other side of the frame onto the wheels.
54. Insert a 1-hole nut holder into one the slots of the other end of the 810mm bar, slide the nut holder to be flush with the end of the bar.
55. Take an end-cap (no wheel) and insert it into that end of the 810mm bar, taking care that the foot (round bump) side of the end cap is under the frame and slide to align the side screw hole with the bolt



Fig. 23-11

The feet of the stand.

in the slot. Insert a bolt (no spacer) and screw it into the bolt.

56. Slide the end cap so that the end is flush with the end of the 810mm bar and secure by tightening the bolt.
57. Repeat the previous 3 steps for the second end cap.
58. Take the 8 protective end caps and insert two on the upper ends of the vertical bars (top of the frame), two on the exposed ends of the mid-joint of the vertical bar and two on the ends of the 810mm bars next to the end caps with no wheels.
59. Make one more final check that all bolts of the frame are tight.

The frame assembly is now complete.

ADJUSTING THE OVERALL HEIGHT OF THE STAND

The stand is designed to be useful in a variety of scanner environments. The overall stand height is not designed to be changed often (e,f, day by day) however it can be adjusted for a particular environment by changing the length of the vertical assembly using the 6-hole joints. To change the height of the stand:

1. Remove any camera from the stand to protect it from accidental impacts.
2. Loosen 3 of the vertically aligned bolts of one of the 6-hole joints (do not remove them, but loosen them enough to allow the vertical bars to slide). Do the same with the 3 holes of the 6-joint plate on the

other side (to allow free sliding of one of the 810mm bars of the vertical assembly).

3. Carefully slide the lower 810mm bar of the vertical assembly so the entire vertical assembly is the desired length and tighten the 6 bolts again
4. Perform the same operation for the other vertical leg assembly.
5. Replace the camera.

INSTALLING THE VEGA CAMERA AND ETHERNET CONNECTIONS

1. Take the Vega camera out of its box (if not already done)
2. Note the 4x M4 holes on the back of the camera.
3. While holding the camera against the camera mount, line up the 4 holes of the camera mount with the 4 holes of the camera
4. Using the 4 M4 screws and a 3mm hex tool, secure the camera to the mount.
5. Unpack the Ethernet/optical converter.
6. Gather one Ethernet optical converter, the Vega power supply (with power cable), short Ethernet cable and long Ethernet cable.
7. While consulting with the relevant technical representatives of the MRI suite, place the Vega power supply in a location acceptable to the MRI staff with access to AC power (likely a filtered power

source). Place the Ethernet/Optical adapter and power supply at the same location and ensure both the Vega power supply and Ethernet/optical adapter have access to AC power.

8. Connect the short Ethernet cable between the Ethernet connector of the Ethernet/optical converter and the Data-in of the Vega power supply.
9. Connect the long Ethernet cable to the Data+power of the Vega camera and connect the other end to the Vega camera.
10. Use the velcro straps to secure the cable to the stand in a way as to prevent it from obstructing normal access to the scanner and surrounding space.
11. With the assistance or approval of the MRI suite staff, take the optical fibre and run it through the waveguide so one end is near the Ethernet adapter/Vega power supply and the other end will be near the location of the Brainsight computer.
12. Connect the fiber-optic cable to the Ethernet/optical adapter
13. Connect the other end of the fiber-optic cable to the second Ethernet/optical adapter.
14. Connect the power adapter of the second Ethernet/optical adapter to appropriate AC power.
15. Connect the third Ethernet cable to the Ethernet port of the Ethernet/optical adapter and the Ethernet adapter of the Brainsight trolley, or directly into the Ethernet port of the Brainsight computer.

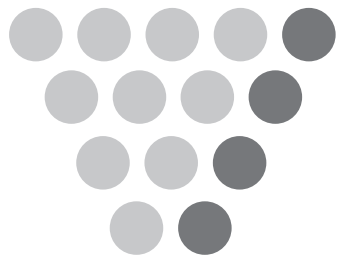

Fig. 23-12

The assembled stand.

Brainsight[®]

NIBS



Rogue Research Inc.

Rogue Research Inc.
300-6666 Rue St. Urbain
Montreal, QC H2S 3H1
Phone: (514) 284-3888
Toll Free (North America):
1-866-984-3888
Fax: (514) 284-6750
<http://www.rogue-research.com>